



**EVERY LITTLE LIGHT FOR SAFETY**

**MAKE SAFETY EASIER**



**STARS PLASTIC SAFETY DEVICE**

**[WWW.STARSPLASTIC.COM](http://WWW.STARSPLASTIC.COM)**

**ISO9001:2008 CE**

**2016 Version**



SP(Stars Plastic Safety Device) is an 18 years old manufacturer for lighting application products in safety industry, we design and produce most of products in our own plant.SP's mission is to develop quality, innovative lighting application products that help people to makesafety easier, So we want to produce every little light for safety.

**OUR PRODUCTS**

Now, We have more than 200 products conform to MUTCD , ASTM, AS/MZS and CE Standard. Our product range cover led traffic control baton, barricade lamp, led traffic sign, led beacon, solar road sutt. Thanks to our members which with for more than 15 years, we can produce quality and pricing product to keep the competitive advantage.

**MANUFACTURING**

18 years, SP has been synonymous with innovation, quality and reliability. Internationally recognised as the leading independent Personal Protective Equipment manufacturer in China, SP is totally dedicated to manufacturing a broad range of equipment designed to give people the protection they need in their lives and workplace.

SP has total control of the safety manufacturing process , starting with sourcing and sorting materials from internationally recognised suppliers, to moulding and assembly, and finally packaging of the many products in the safety range. High ongoing investments in plant sites and latest machinery equipment, has allowed vertical integration of manufacturing - ensuring direct quality control of the complete programme.

**OUR HONERS**

- SP has passed ISO9001: 2008 quality management system
- SP had Obtain the patent for most of products and parts
- All of our traffic baton , warning light and solar traffic sign series had get the CE certificate
- Our factory has been ranked Class AA on the list of Zhejiang Industry and Commerce Enterprises who Follows Contract and Observes Credit.



# STARS PLASTIC LAB

In order to develop more reliable products, Stars Plastic Build our own lab at 2015. Now we can test the exact light intensity in different area of lens by using Multiplex Photometer, Using the Fast aging Machine to see the product performance in different weather conditon, such as raining test, UV test, condensation test. For some car mounted product, we are using shaking test machine to test the reliability of product before packing. Also Stars Plastic develop some special equipment to test our product according to En12352:2006 European standard and ITE for USA standard. In the future Stars Plastic will have more testing equipments to meet different standard all over the world.



Lab Video



LED Tester



Shake Tester



Fast Aging Machine



Integrating Sphere

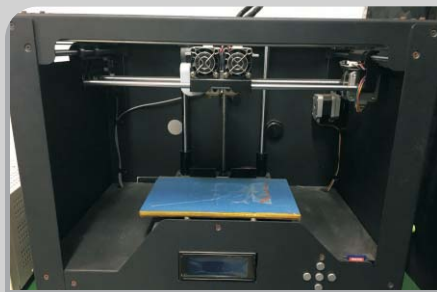

3D Printer



Solar Batteries Tester



Digital Storage Oscilloscope



Water Spraying Machine

































Multiplex Photometer

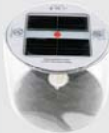

Luminance Meter

# CONTENT

01-03  Arrow Board	04  Externally Lit Sign	05  Internally Lit Sign	06  Intelligent Sensor System	08  Traffic Direction Sign
09  Wireless Guiding System	10-12  Heavy-duty Barricade light	13-14  Transformers Barricade Light	15-19  Budget Barricade Light	20  Fast Mounted Cone Lamp
21-22  MAGA Series Road Stud	23  Plastic Road Stud	24  Buried Light	25-26  Heavy-duty Traffic Baton	27-29  900 Series Traffic Baton
30-32  700 Series Traffic Baton	33-34  260 Series Traffic Baton	35-37  Traffic Baton	38  Expandable Traffic Baton	39  Safety Hammer
40  Solar Traffic Baton	41  LED Beacon	42  Economic Type Strobe Beacon	43  Heavy Duty Strobe Beacon	44  Solar LED Beacon
45  Japan Anti-animal Light	46  Mini Solar Cone Topper	47  Inflatable Solar Lanter	48-49  Battery LED Beacon	50  Pole LED Beacon
51  Multi-function LED Flare	52  Corner LED Flare	53-54  Marina Lantern	55  Expandable Barrier	56  Accessories



Arrow boards direct traffic by flashing a brightly lit arrow pattern on a large, highly visible display panel. Truck-Mount Arrow Boards provide an obvious solution for convoys, crash-cushion (TMA) trucks and emergency repair crews. Installed over the cab or in a truck bed, power is provided by the truck's power system. Arrows and other patterns are selected by the user using the arrow board controls inside the truck cab.



Without Bracket



With Actuator

## Construction

Material	Aluminum sheet and welded channels
Coating	Powder-coated and oven-baked
Wiring	Color-coded
Cable Length	15 ft. (4.57 m) standard; custom lengths available upon request
Connection	Screw-type locking collar secures plug-in cable socket to control box
Voltage	12V or 24V are optional
Slight-emitting element	PAR 36 (50pcs LED inside) & PAR46 (40pcs LED inside) are applied to different sizes
Trailer	2 different types of trailers are optional for type C arrow board

## Lamp



PAR 46



PAR 36

## LINAK<sup>®</sup> Actuator



Optional Actuator

## Advantages

- Optional automatic dimming
- Easy to operate and maintain
- Flash rate of 60 times per minute
- High-output PAR elements provide superior visibility
- Positive-drive voltage system applies power to lamps only when lit
- Control box outputs have short-circuit protection, helping prevent blown transistors
- Element and visors are easily replaced

## Arrow Board Controller Box











ST-SU-A



















ST-SU-B



## Flashing patterns

- |          | Pulse1  | Pulse2  |                               |
|----------|---|---|-------------------------------|
| <b>A</b> |  |  | Flashing arrow, left or right |
| <b>B</b> |  |  | Flashing double arrow         |
| <b>C</b> |  |  | Flashing four-corner warning  |
| <b>D</b> |  |  | Flashing caution-bar warning  |

## Sequential patterns

- |          | Pulse1  | Pulse2  | Pulse3  | Pulse4  |  |
|----------|---|---|---|---|--|
| <b>E</b> |    |    |    |    | Sequencing arrow, left or right          |
| <b>F</b> |    |    |    |    | Sequencing stem arrow, left or right     |
| <b>G</b> |   |   |   |   | Sequencing chevron arrows, left or right |
| <b>H</b> |  |  |  |  | Alternating diamonds                     |

All arrow board can display any of <A,B,C,D> 5 patterns; 15- and 25-elements sign can display <E> 2 patterns; 25- elements arrow boards can display <F,G,H> 5 patterns



Type B with Ordinary Actuator











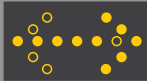

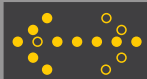

Type C Trailer-mounted

MUTCD Type	Size	Lamp Quantity	Lamp Size	Max.legibility Miles(km)
A	24*48 (60.9*121.9)	13	PAR 36	0.5(0.8)
		15	PAR36/PAR46	0.75(1.2)
B	30*60 (76.2*152.4)	25	PAR 36	0.75(1.2)
		15	PAR 46	0.75(1.2)
	36*72 (91.4*182.8)	25	PAR 46	0.75(1.2)
		25	PAR 46	0.75(1.2)
C	48*96 (121.9*243.8)	15	PAR 46	1(1.6)
		25	PAR 46	1(1.6)

Following 4 different sizes are optional, meet MUTCD standard, suitable for market of American, Canada, etc.

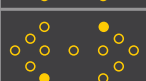
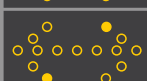

	Size A Function	Size B and C Function	
Arrow Right			
Arrow Left			
Double Arrow			
Non-directional Warning			
			



Size A with LINAK® Electric Actuator

Type	Size	Lamp Quantity	Lamp Size	Max.legibility Miles(km)
A	650*1260mm	13	PAR36/PAR46	0.5(0.8)
B	770*1500mm	15	PAR36/PAR46	0.75(1.2)
C	1200*2400mm	15	PAR 46	1(1.6)

\*For trailer-mounted signs, 2pcs additional elements are located on the rear face of the sign

The above 3 different sizes are optional, meet AS 4192-2006 standard, suitable for market of Australian market.



Size C Trailer-mounted



Super Flux LED on the surface of the sign give out dazzling light.

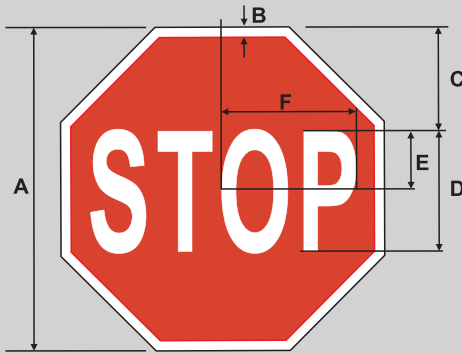

### Advantages

1. Solar powered, Solar panel can be turned up and down & 360 degree rotating.
2. Super FLUX LED covered by unique clear lens, visible distance > 2 miles at dark.
3. Ultra-thin 15mm aluminum board is protected by one piece (but not 8 pieces) aluminum frame, making it totally waterproof and super strong.
4. 3M diamond reflective film & UV printing.
5. Circuit, batteries are hidden inside of the pole, nice looking & not easily to be damaged.
6. Photocell switch for choosing to make it to Auto flash at dark only or 24hs operation.

MUTCD standard, Following 5 sizes are optional (1 in = 2.54cm)

A(Inches)	B(Inches)	C(Inches)	D(Inches)	E(Inches)	F(Inches)
18	0.375	6	6C	3	7.75
24	0.625	8	8C	4	10
30	0.750	10	10C	5	12.5
36	0.875	12	12C	6	15
48	1.250	16	16C	8	20

\*Customized: Different shapes & words or mark.

## Installation







SMD LED inside of the sign gives out soft area light.



### Advantages

1. Lower Energy - Save around 77% energy compared to a conventional externally lit sign.
2. Less Maintenance - Reduced maintenance costs due to the lamp life of >50,000hs & less heat attracting less insects.
3. Slim Design - Conventional internally lit signs have a depth of around 150mm, ours is 15mm.
4. Reduced Light Pollution - Type A signs spread light indiscriminately, ours signs, being internally lit, only the sign is lit
5. More Environmental - No fluorescent lamp disposal, less parts to dispose of at end of life, less carbon footprint due to less maintenance visits
6. Better Visibility - With retro-reflective material the signs have improved light distribution and better angular vision.
7. Ease of Installation and Replaceable Parts - Plug and play installation and in the event of a part failure, component replacement is possible. Even the sign face can be changed

### Item

### Size(mm)

### Image

#### Circles

ILS-C450	450
ILS-C600	600
ILS-C750	750
ILS-C900	900



#### Triangles

ILS-T600	600
ILS-T750	750
ILS-T900	900



#### Rectangle

ILS-R3045	300*450
-----------	---------



#### Back to Back Signs-Circles

ILS-C600B	600
-----------	-----



#### Back to Back Signs-Triangles

ILS-T600B	600
-----------	-----



\*Customized: Different shapes & words or mark.



### Intelligent sensor system

Equipped with an intelligent sensor system, when a passenger crossing the road through the sidewalk, no matter in day or night the solar traffic sign will automatically flash, to warn the motorist to slow down that a person is crossing the road. This function is effective to reduce traffic accidents especially at night. Two different working styles can be chose as optional A and B.



### <Optional A>



#### <Optional A>

Wireless Bollard Activation

— Pedestrians and bicyclists can passively trigger flashing. Actuators are housed in anodized aluminum cabinets that can be secured to concrete or asphalt. Battery operated: no grid wiring required.



Sidewalk - when passengers cross the road ,the signs auto flash to remind cars to slow down, until passengers pass the road. It can reduce traffic accidents, especially in the night.



### <Optional B>

Garage Exit - The sign auto flash when vehicles leave the garage.



#### <Optional B>

Pedestrian Motion Detector

— Active infrared and microwave technologies work together to provide precise presence and accurate motion detection. Impervious to light, sun rain and snow.



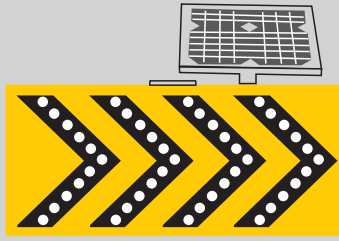

ST-STS-4A

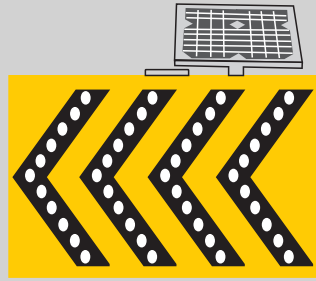

ST-STS-4D

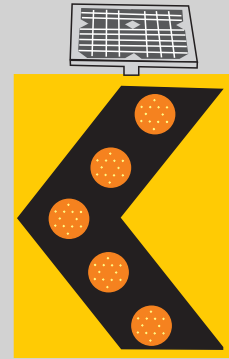

ST-STS-3B

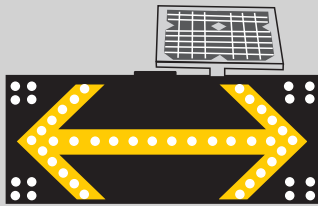

ST-STS-4C

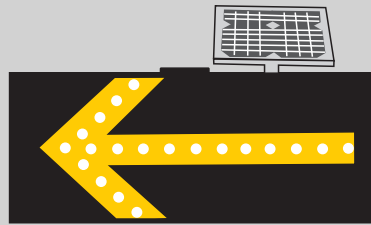

ST-STS-4B

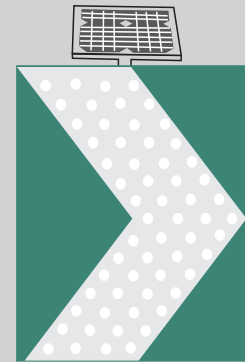

ST-STS-3D

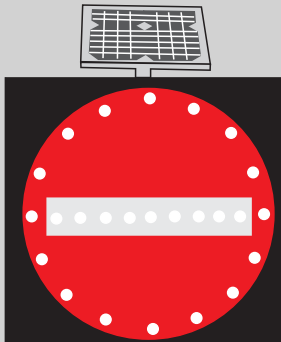

ST-STS-4E

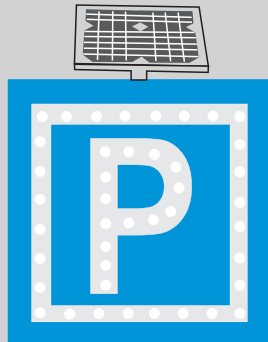

ST-STS-2B



ST-STS-1A



ST-STS-1A



ST-STS-2C



ST-STS-2C



ST-STS-2D

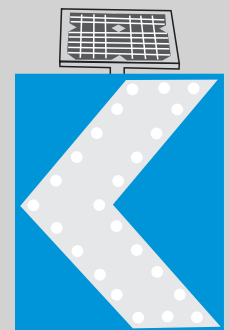

ST-STS-3C



AB-4685/AB-2648



AB-A4685



AB-3636



AB-4545



AB-5252

Bright LED lighting with high reflective sheet

Visual distance: more than 200m

With magnet on the back

Small size, easy to take



Item No	Size	Function	LED Number	Color
AB-4685	(L)85cm*(W)46cm	Flash in turn-Close	36PCS	Red/Black
AB-A4685	(L)85cm*(W)46cm	Flash in turn-Close	30PCS	Black
AB-2648	(L)26cm*(W)48cm	Flash in turn-Close	28PCS	Red/Black
AB-3636	36cm*36cm	Flash-Close	12PCS	Red
AB-4545	45cm*45cm	Flash-Steady-Close	12PCS	Red and Black
AB-5252	52cm*52cm	Flash-Steady-Close	15PCS	Red and Black

The wireless guiding series is designed to be a simply deployable low cost counter measure device which would not only dynamically enhance the visibility of the work zone entrance but at the same time improve driver lane discipline and approach speeds by providing a clear directional guide.

It combines the latest in LED lamp and lens technology with intelligent synchronization wireless communications technology to improve night-time driver recognition of the merging taper and help meet the challenge of reducing work zone fatalities and secondary effects.



Same Time Flashing

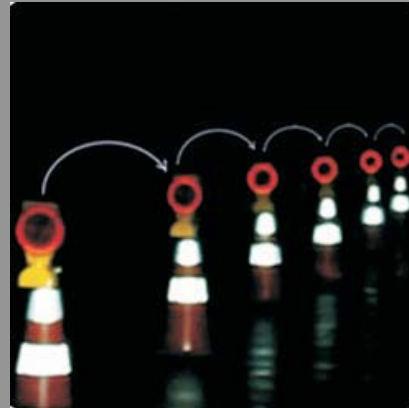

Sequential Flashing

Two different technologies are optional(INFRARED tech / WIFI tech), to make a series of lamps to flash orderly

### COMMON ADVANTAGES OF THE TWO TECHNOLOGIES

- Two types of working modes are optional  
 Same time flashing – the series of lamps flash together at the same time. (Patent tech)  
 Sequential flashing – the series of lamps flash one by one orderly.
- Solar powered available – can be applied to solar warning lights, due to our electronic chip is energy-efficient. No any other manufacturers can make it at the moment.
- According to the scientific experiments, orderly flash modes calm drivers down to slow cars down.

## DIFFERENCE OF THE TWO TECHNOLOGIES

INFRARED Tech	WIFI Tech
<ol style="list-style-type: none"> <li>1. Deployed in any order – no master or slave Any lamp can be moved from the system, has no impact on the flashing function</li> <li>2. Lamps must be installed in a line, face to face &amp; distance of neighbouring lamps must less than 15meters.</li> <li>3. Up to 250 lamps can be deployed in sequence.</li> <li>4. Can not be applied to metal material products.</li> </ol> <p>Fitting list            Transformer series: AB-SU309, AB-SU310, AB-SU311, AB-370            Heavy-Duty series: HD-4D, HD-6V, HD-2D</p>	<ol style="list-style-type: none"> <li>1. All lamps in sequential flashing series are numbered (1, 2, 3, 4, . . .), can't mixed &amp; no lamp can be moved from the system.</li> <li>2. Lamps can be installed anywhere (distance of neighbouring lamps should be within 200meters space), no angle requested &amp; can be at different height.</li> <li>3. Thousands of lamps can be deployed in sequence</li> <li>4. Can be applied to metal material products.</li> </ol> <p>Fitting list            Transformer series: AB-SU309, AB-SU310, AB-SU311, AB-370            Heavy-Duty series: HD-4D, HD-6V, HD-2D            Solar marine Light, AB-9R LED flares, LED beacons            Aluminum solar road stud</p>



INFRARED Tech Function Vido



WIFI Tech Function Vido

HEAVY - DUTY BARRICADE LIGHTS feature the industry's brightest LED optic lens, which produces 20% more light output when compared to other brands. These barricade lights are built with heavy-duty, PC lens and PP unbreakable case to withstand the high impact and harsh weather conditions frequently experienced in construction and other industrial applications.

**PRODUCES 20% MORE LIGHT OUTPUT THAN COMPETITIVE BRANDS!**

## ADVANTAGES OF STARS PLASTIC HD BARRICADE LIGHTS

Meet MUCTD & ITE Standard

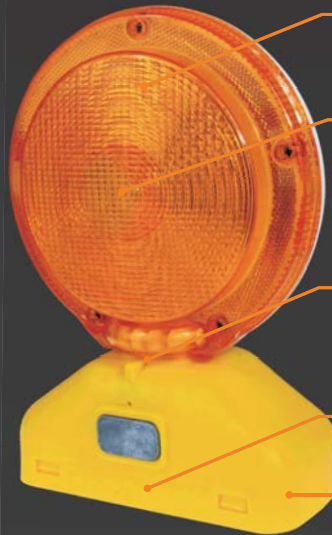

Unbreakable lens withstands high impact and pressure

Our original LED optic lens design set the standard for the industry as it allows for 20% more efficient light output when compared to other brands

Lens continuously rotates 90° for easy adjustment to any angle

Personalize your lights by molding your company logo into area

Case made of unbreakable PP, which withstands all types of impact and extreme weather conditions

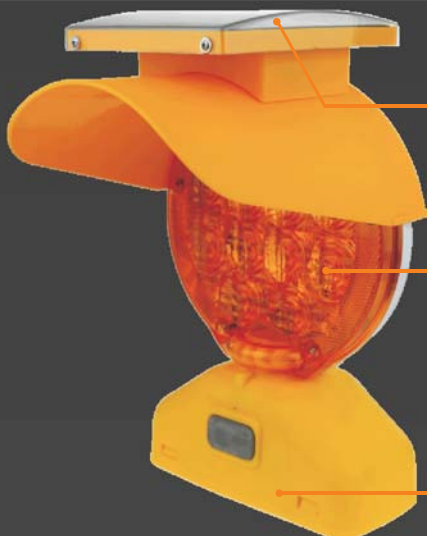

Normal or PRO solar panel optional

12pcs super bright LED  
Function: 4Quad Flashing-Closed

Unbreakable PP single lens withstands high impact and pressure



## Type A/C (Steady-Flash-Close)



HD-4D

HD-6V

## Type A/C Solar Series (Steady-Flash-Close)



HD-4DSU

HD-6VSU

## Type B (4Quad Flash-Close)



HD-4DB12

HD-6VB12

HD-4DB

HD-6VB

## Type B Solar Series



Optional  
 Use 2\*2000mah Li-battery Power:2.5W  
 Use 4\*2000mah Li-battery Power:2.5W

## Type D (360° Visibility)



- Most durable & efficient barricade light on the market
- Function: steady
- With 6 LEDs
- The material : Lens:PC; base:ABS; the bottom base: PP
- Lens available in different colors

Model	Description
HD-4DD	D-Cell, Type D
HD-6VD	6 Volt, Type D
HD-4DDSU	Solar, Type D
HD-6VDSU	Solar, Type D

## Type A/C (Steady-Flash-Close)



HD-2D

HD-2DH

## Type A/C Solar Series (Steady-Flash-Close)



HD-2DSU

HD-2DHSU

## Type B (4Quad Flash-Close)



HD-2DB12

HD-2DHB12

HD-2DB

HD-2DBH

### Optional function:

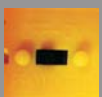

HD-2D series,  
photo control switch optional



Type B series, visor optional

### Accessories for 4D and 6V Type:

Equip 1pc\*Push Pin & 1pc\*Bolt for Each barricade light



Equip 1pc\*Wrench for each carton(12pcs)



Two sizes for Bolt are available : 3.5" or 3.875" (88.9mm or 98.4mm)

Small size for D batteries base; big size for 6V batteries base



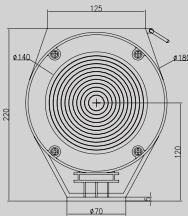

AB-SU309



AB-SU309A



AB-SU309B



AB-SU309C



AB-SU309D



AB-SU309E



AB-SU309F

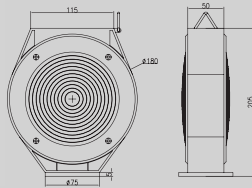

AB-SU310



AB-SU310A



AB-SU310B



AB-SU310C



AB-SU310D



AB-SU310E



AB-SU310F



AB-SU310G

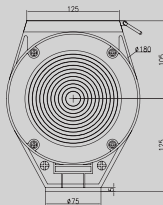

AB-SU311



AB-SU311A



AB-SU311B



AB-SU311C



AB-SU311D



AB-SU311E



AB-SU311F



Emergency Charger optional



Optional screw for panel of traffic sign



AB-SU311-5

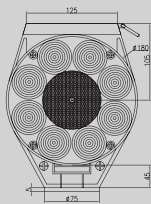

AB-SU311A-5



AB-SU311B-5



AB-SU311C-5



AB-SU311D-5



AB-SU311E-5



AB-SU311F-5



Emergency Charger optional



Optional screw for panel of traffic sign

	Material	Len	LED	Function
<b>AB-SU309</b> (E and F: Solar & Battery Twin Power Supply Available)	Frame: PP Shell: AS	Double lens with advanced optics for high visibility	2 or 4pcs high intensity LED bulbs	Flash-4Quad Flash-Steady-Close
<b>AB-SU310</b> (E and F: G: Solar & Battery (Two 6V 4R25) Twin Power Supply Available)	Frame: ABS Shell: PC	Double lens with advanced optics for high visibility	2 or 6pcs high intensity LED bulbs	Flash-4Quad Flash-Steady-Close
<b>AB-SU311</b> (E and F: Solar & Battery Twin Power Supply Available)	Frame: ABS Shell: PC	Single len with advanced optics for high visibility	6pcs high intensity LED bulbs	Flash-4Quad Flash-Steady-Close
<b>AB-SU311-5</b>	Frame: ABS Shell: PC	Single len with advanced optics for high visibility	9pcs red LED bulbs	Chasing Flash-4Quad Flash-Flash-SOS Flash-Close

### ADAPTERS FOR TRANSFORMER SERIES



T-A

Cone/Post Topper



T-B

Barrier Mounter



T-C

Cone/Barrier Mounter



T-D

Surface Mounter



T-E

6-Volt Water  
Barrier Mounter



T-F

Cone/Barrier Mounter



T-G

Hand Hold Adapter



T-K

Pole Mounter



T-L

Cone Topper  
(Turkish Style)



T-H

D-Cell Adapter



T-I

Surface Mounter



T-J

Pole Adapter(360° )

### Application

I Hand hold application

III Hook Application

V Sureface Fixed Application with screwed hole

VII Traffic sign Application for AB-SU311

IX Barricade Application for standard metal bracket

XI Traffic Cone Application For multi-function case

II Pole Application

IV T-post Application with multi-function case

VI Top Hangle for AB-370

VIII Barricade Application for 360° rotating metal bracket

X Barricade Application for the 360° rotating frame

XII Traffic Cone Application For AB-370



### AB-SU320 SERIES

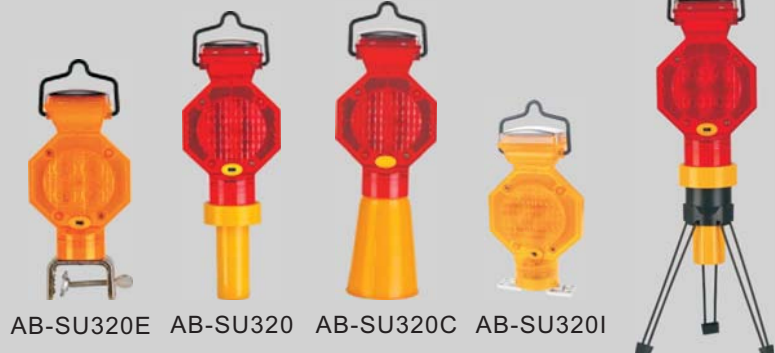
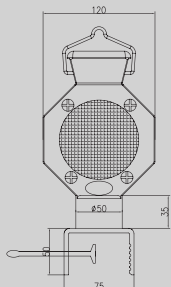
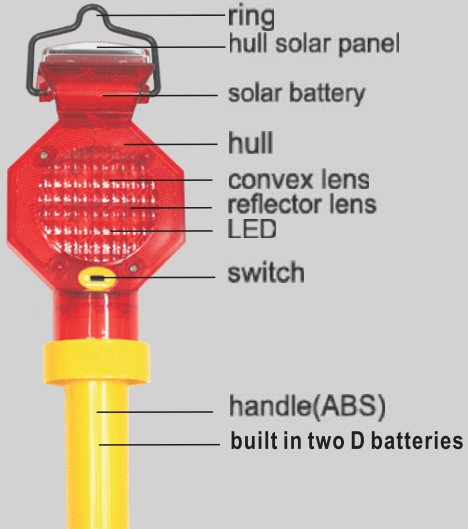

8pcs ultra bright LEDs  
 Color:Red/Yellow  
 Function: Flash-Close  
 Automatic light control,on at dusk,off at dawn  
 Switch for power choose: Solar or battery operated.  
 Battery: One 3.2V Lithium rechargeable battery and Two D batteries.  
 Convex lens on its shell increase the light scope



### AB-305 SERIES

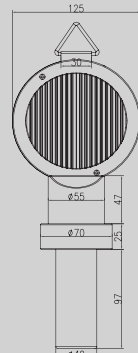

The four convex lens in each side enlarge the output of the light source for the better visible effect, can use on hand holding or put on the traffic cone.



Function Video

8pcs ultra bright LEDs  
 Color:Red/Yellow  
 Function: Flash-Close  
 Automatic light control,on at dusk,off at dawn  
 Size:(H)30cm\*(DIA)12cm

### AB-SU150 SERIES

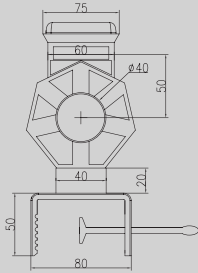

Function Video

Available colors: red and yellow

6pcs ultra bright LEDs

Battery: 2 Pcs of Ni-MH 1.2 V rechargeable batteries (with the solar energy and light control)

Function: Flash in turn or Flash-Close

Photocell: auto on at dusk, off at dawn



AB-SU150A



AB-SU150B



AB-SU150C



AB-SU150E



AB-SU150I



AB-SU150D



AB-SUL150D

### AB-258/308/375 SERIES



AB-258



AB-258B

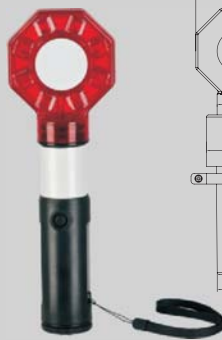

AB-M258

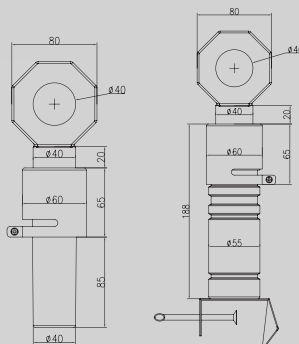

Function Video



AB-308



AB-375



AB-A375

Item No	Battery	Function
AB-M258	Three AA	Take turn to flash-Together flash-Steady-Close
AB-258	Two D	Together flash/Take turn to flash
AB-258B	Two D	Together flash/Take turn to flash
AB-308	Two D	Together flash/Take turn to flash
AB-A375	Three AA	Take turn to flash-Together flash-Steady-Close
AB-375	Two D	Together flash/Take turn to flash

### AB-SU250 SERIES



AB-SU250



AB-SU250-1

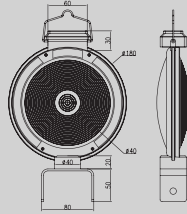

Available colors: red and yellow

AB-SU250-1 by using optical lens

Ultra bright LEDs: AB-SU250--6pcs AB-SU250-1--2pcs

Rechargeable Batteries : AB-SU250-- 2 Pcs of Ni-MH 1.2 V  
AB-SU250-1-- 1 Pcs of Ni-MH 1.2 V

Photocell: auto on at dusk, off at dawn

With different base for various usage



AB-SU250C



AB-SU250E



AB-SU250A



AB-SU250B



AB-SU250D



Function Video



AB-SU250C-1



AB-SU250E-1



AB-SU250A-1



AB-SU250B-1



### AB-220 SERIES



AB-220A



AB-220C



AB-220B



AB-220E



AB-220D

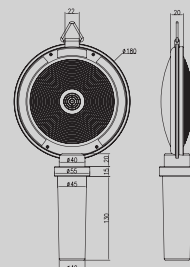

6pcs ultra bright LEDs

Function: Flash-Close

Photocontrol

Color: Red/Yellow

Battery: Two D batteries.

### AB-210



AB-210A



AB-210B



AB-210C



AB-210D



AB-210E



Function Video

3Red+3Blue ultra bright LEDs  
 Battery: Two D Battery  
 Photocontrol

Material: Handle: PP PE Shell:AS  
 Function: Red Flash- Blue Flash- Red and Blue Flash in turn- Close  
 Photocontrol

### AB-SU105/AB-SU100



AB-SU105A



AB-SU105B



AB-SU105C



AB-SU105D

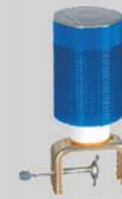

AB-SU105E



Function Video

6 ultra bright LEDs  
 Battery: 2pcs of Ni-MH 1.2V  
 Photocontrol

Material: Handle: ABS or PE Shell:AS  
 Function: Flash - Close(AB-SU105)  
 Red and Blue Flash in turn(AB-SU100)

### AB-SU350



AB-SU350A



AB-SU350I



AB-SU350J



Function Video

Material: ABS and the LED section with Acrylic  
 Battery:600mA 3.2V  
 4pcs high intensity LED bulbs  
 Function:Flash or Steady

#### Features:

Solar warning light has 4 big LED totally and flashing frequency reach to 77 times per minute. There is a solar panel on the top of the light and reflector paste on both sides of the light. It can be fixed with multiple base in different places.

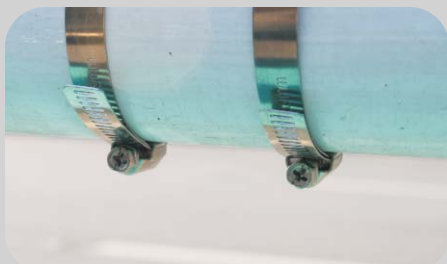

## ST-121



ST-121



ST-121Y



ST-121R



ST-121RB

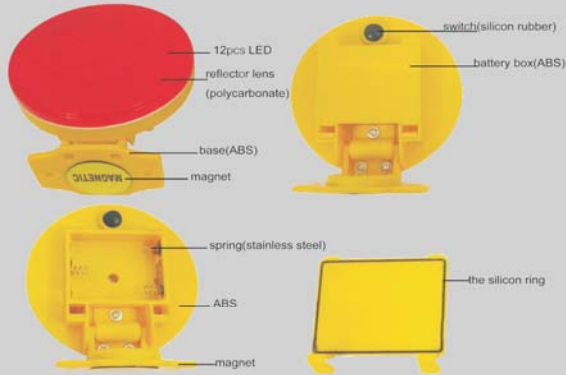

Size: (H)5cm\*(DIA)10cm  
 Battery: Three AA  
 12pcs ultra bright LED bulbs  
 Function: Flash-Close

Light color: Red/ Yellow  
 With magnet on the bottom, can be attached on car  
 The reflector on the lens side can show the signal for drivers in the darkness  
 Water-proof and portable



Function Video

## AB-265 SERIES

Size: (H)26.5cm\*(DIA)12cm

Battery: Two D



AB-265R



AB-265Y

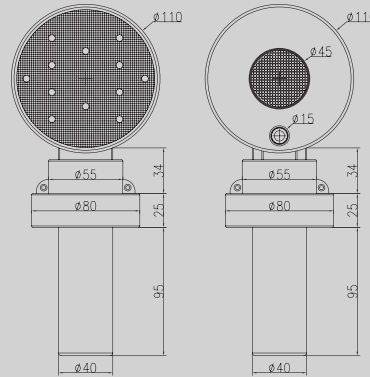

Function Video

## WL-A08-01



WL-A08-01

Material: PP and Anti-UV  
 Battery: 1200mA Ni-Mh  
 1 or 3pcs Super Luminosity LED  
 Function: Flash or Steady





### Cone LAMP



AB-185



AB-SU185

- Internally mounted "on/off" switch, automatically activates when placed onto a cone and deactivates when taken off
- High intensity LED: Flashing Or Non-flashing operation only
- Photocell fitted as standard, extending battery life Particularly suitable for long operating times
- Battery power: 1pc 4R25 battery(Not included)
- Solar function optional: The first new design for this Cone LAMP Solar panel is protected by PC cap, with a special design, can not be broken even drop it from high height
- Wireless sequential flashing guide system optional



Same time flashing



Sequential flashing

- To be designed according to EN12352



### Item:

AB-185F(Flash Type)

AB-185NF(Non-flash Type)

AB-SU185F(Solar Flash Type)

AB-SU185NF(Solar Non-flash Type)

### Examples of application

- at accident scenes
- in case of rescue operations
- in case of vehicle breakdowns
- in case of maintenance works on the side of a road







### Features:

High quality reflector meets Euro reflective road stud standard

Brushed aluminum frame with thickened smooth edges reduces the impact to car wheels.

Embedded reflector is protected by thickened aluminum frame & anti-corrosive coating.

Unique glue makes MAGA series to bear >30T weight & totally waterproof IP68.

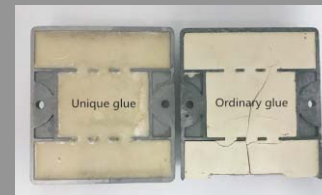

Solar powered & Auto work (Flash/Steady) at dark only

Magnet switch (Optional): Special design of the internal circuit to make MAGA to be turned ON/OFF by an external mini-Magnet, it's good for long time storing.

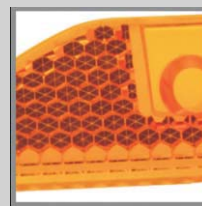
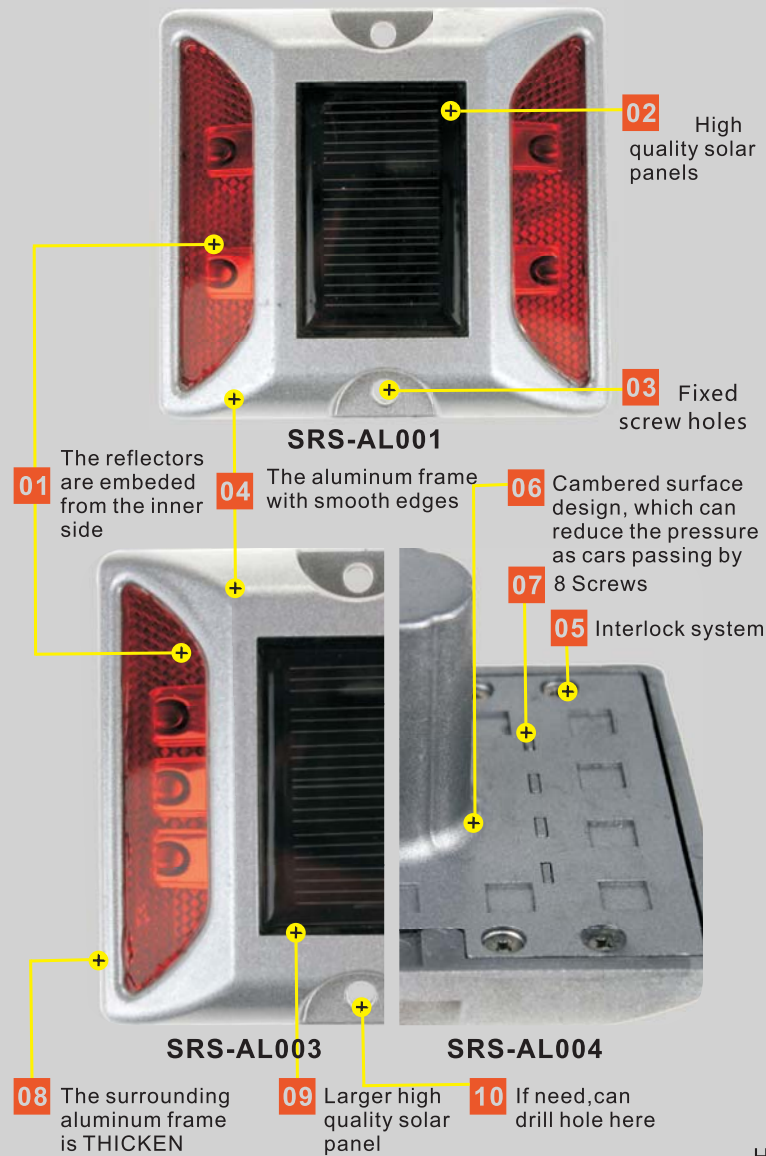

High Quality Reflector



Thickened Smooth Edges



Unique Glue

Item No	Size	LED Number	Material	Lighting Mode	Power Supply	Solar Panel	Weight
SRS-AL001	100*110*23mm		Acrylic Reflector Aluminum Frame	Flashing/ Steady	1.2v 750mah NI-MH battery	3V 90mA	300±10g
SRS-AL003	105*125*25mm	φ 5mm 4/6pcs (Dual side)					400±10g
SRS-AL004	105*125*75mm (Leg:50mm)						500±10g



SRS-AL001



SRS-AL003



SRS-AL004

**SRS-AL005/006**

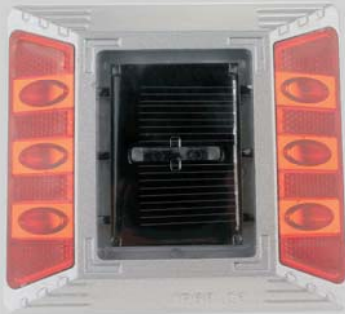

**SRS-AL005**



**SRS-AL006**

Item No	SRS-AL005/SRS-AL006
Size:	132*122*19.7mm/132*122*75mm
Thickness is	19.7mm only, can be used on USA highway
Solar panel	:0.3W
NI-MH battery	1.2V/600mAh
Work mode:	Flash / Steady
Be charged 8hours:	Flash mode 48hours or Steady mode 12hours
Be fully charged:	Flash mode 72hours or Steady mode 20hours
Color:	Red, Yellow, White, Green, Blue
	3PCS super bright DIA 5mm LED per sided
	Single side or Double sides optional
Visibility distance:	> 1000 meters
Lifetime:	3 to 5years
Material:	Acrylic Reflector + PC cap + Aluminum frame
Compression resistance:	over 30 tons
Waterproof	>Ip68



**SRS-AL002**



**SRS-AL002**

Item No	SRS-AL002
Material	Aluminum alloy
Size	115*100*22mm
Flash Rate	90-100 times/minute
LED	φ 5mm, 6pcs (Dual Side)
Luminous Color	Red/Yellow/Blue/Green/White
Power Supply	1.2v 600mah NI-MH battery
Working time	Over 60 hours after full charged

## /// SRS-PC007

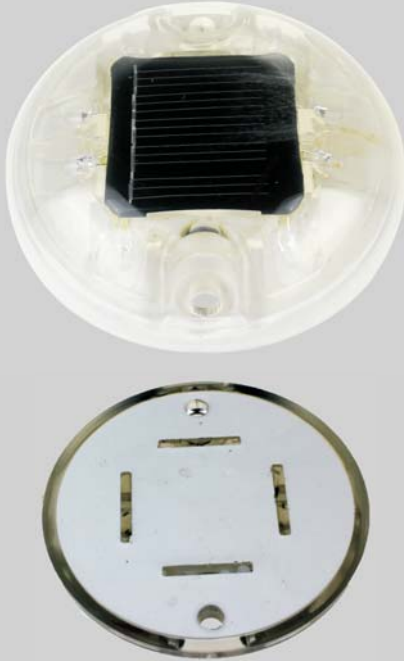

SRS-PC007

### Item No

**SRS-PC007**

Material: PC  
 Size: Dia. 115\*23mm  
 Function: Flash or Steady  
 8PCS Diameter 5mm High Brightness LED  
 LED color: Red/Yellow/Blue/Green/White  
 Battery: Ni-Mh, 750mAh  
 View distance: over 1200m  
 Temperature range: -20°C to 60°C  
 Waterproof: IP68  
 Application: Walkway, Highway, Garage, Airport etc.

## /// RS-A08-006

### Item No

**RS-A08-006**

Solar Cell: Polycrystalline Silicon/Monocrystalline Silicon  
 Light Source: Super Luminosity  
 Luminous Mode: Varying Type/Constant Type  
 Work Time: 108 hours above Varying Type; and more than 24 hours for  
 Constant Type(full charge constant ON)  
 Work Temperature: -25°C--75°C  
 Light Material: Polycarbonate  
 Waterproof Grade: IP>67  
 Life: >5years(Ni-MH) or >15years(Super Capacitor)  
 View Distance: Over 800m  
 LED Color: Red/Yellow/Blue/Green/White



RS-A08-006

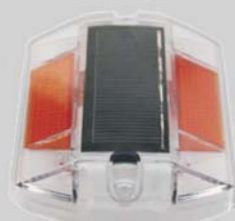
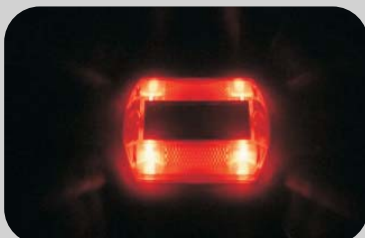



Solar eye LED buried lights are widely used in the green belt, park lighting engineering, park, lawn, garden lighting, street, park, square lighting, decorative bridge building, road lighting.

It uses solar energy as the source of energy, charging during the day and using in the night ; Its with light control, time control and microcomputer intelligent control; LED light source, environmentally batteries; relying on the surrounding environment, activities, personalized and re-creation; modular, maintenance-free design. Stylish, elegant, could decorate courtyards, squares, roads, parks, playgrounds and other public outdoor spaces with beautiful dress; and also as the border indications to those rural roads or special regional road (Like swimming pool etc)



**BL-001**



**BL-A06-02X**



**BL-A06-03LQ**



**BL-A06-03LZ**



**BL-A06-05LQ**

Solar panel:0.1w  
 LED Quantity:1 pc  
 LED color: Red/Yellow/Blue/Green/White  
 Battery: Ni-Mh,350mAh  
 Shine Style: Constant lighting/glitter lighting  
 Working time: Constant lighting: Over 8 hours by shined for 8 hours with standard luminous intensity.  
 Glitter lighting: Over 72 hours by shined for 8 hours with standard luminous intensity.  
 Luminous Flux:6lm  
 Water proof:IP68  
 Application: Plaza, Park, Garden, Street, Building ,etc.

Item No	Material	Size
BL-001	PC	50*35mm
BL-A06-02X	PC	40*36mm
BL-A06-03LQ	PC+Aluminum	50*35mm
BL-A06-03LZ	PC+Aluminum	80*35mm
BL-A06-05LQ	PC	50*50*35mm

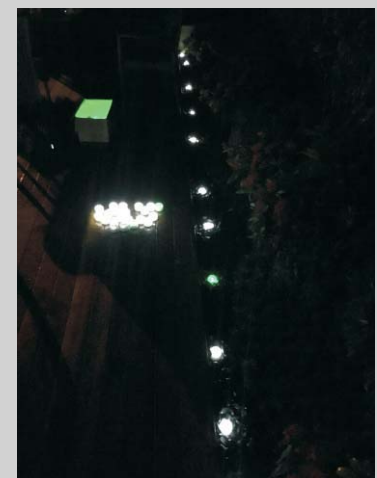
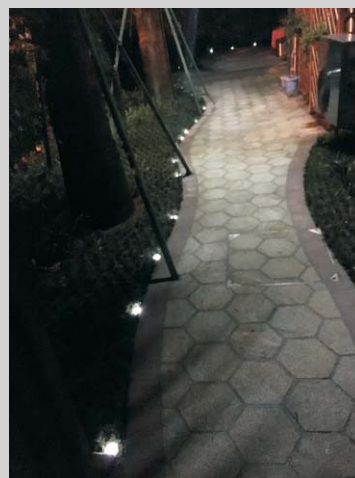



ST-500AA ST-S500AA

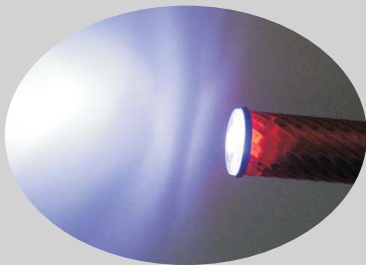
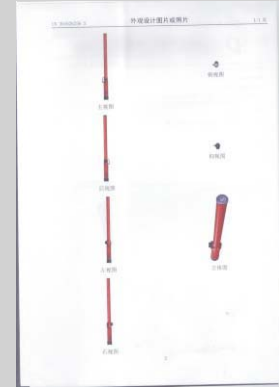

ST-500AA is the best product among all traffic batons. We obtained the patent in 2011. It is rechargeable. PC material and integrated design make it firm and waterproof. Spiral hull enhances its brightness. Three super bright white LEDs on the top used as torch in the dark. Loud alarm can attract people's attention easily.

Design Features	Specifications
Material: Fully made of PC	Visual Distance: More than 500 m
Batteries: 3 pcs AA Battery	Flash Frequency: 4 Hz

Item No	Size	Color	LED number	Function
ST-500AA	(L)54cm*(DIA)3cm	R/B/Y	20+3pcs	Flash-Steady-Top Lighting-Close+Whistle+Magnet
ST-S500AA	(L)43cm*(DIA)3cm	R/BY	16+3pcs	Flash-Steady-Top Lighting-Close+Whistle+Magnet



ST-395R



ST-395RB/RG

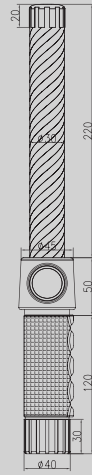

### Design Features

Material: Fully made of PC

Batteries: 3 pcs AA Battery

Function: Flash-Steady-Top Lighting-Close

### Specifications

Visual Distance: More than 500 m

Flash Frequency: 4 Hz

(L)39.3cm\*(DIA)3cm

Item No	Function	LED number
ST-395R	Flash-Steady-Top Lighting-Close+Whistle	14R+1W
ST-395RB	Red Flash-Blue Flash-Red and Blue Flash in turn-Top lighting-Close	7R+7B+1W
ST-395RG	Red Flash-Green Flash-Red and Green Flash in turn-Top lighting-Close	7R+7B+1W

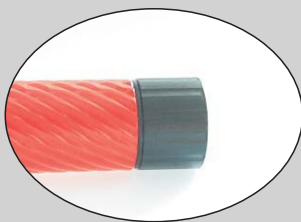

Different top cover to ST-500



Special convex lens design for top light

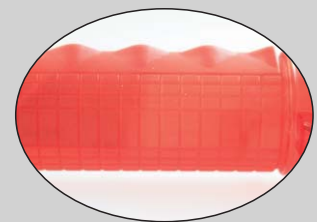

Prevent the hand sliding handle design  
Flexible paint handle



Rechargeable is available



Magnetic is available



Whistle



## ST-900 SERIES

Traffic baton is an effective product which makes great influence on traffic control aspects. It will play more and more important role in the safety control field. Stars Plastic Factory is specialized in traffic baton for more than 15 years which could make it easily for us to reach our aims: MAKE SAFETY EASIER.



ST-900R

ST-900G

ST-900B

ST-900Y

ST-900RGW



ST-L900R



ST-S900R

### Design Features

Function: Flash-Steady-Close.

Battery: 2 pcs D Battery

Rechargeable function is available

LED colors can be chosen

### Specifications

Visual Distance: More than 200 m

Flash Frequency: 4 Hz

Handle=ABS Pipe=PVC

With a sling

Item No	Color	Size	LED number
ST-900	R/G/B/Y/RGW	(L)54cm*(DIA)4cm	6pcs
ST-S900	R/G/B/Y	(L)41cm*(DIA)4cm	4pcs
ST-L900	R/G/B/Y	(L)87cm*(DIA)4cm	12pcs



ST-900R-1 ST-S900R-1



Function: Flash-Steady-White Light-Close.



ST-900R-5

Item No	Color	Size	LED number
ST-900R-1	R/G/B/Y	(L)54cm*(DIA)4cm	6+1pcs
ST-S900R-1	R/G/B/Y	(L)41cm*(DIA)4cm	4+1pcs
ST-900R-5	R/G/B/Y	(L)54cm*(DIA)4cm	6+5pcs



ST-900RG ST-S900RG

Item No	LED number	Size	Function
ST-900RB	6+6pcs	(L)54cm*(DIA)4cm	Red Flash-Red Steady-Blue Steady-Close
ST-S900RB	4+4pcs	(L)41cm*(DIA)4cm	Red Flash-Red Steady-Blue Steady-Close
ST-900RG	6+6pcs	(L)54cm*(DIA)4cm	Red Flash-Red Steady-Green Steady-Close
ST-S900RG	4+4pcs	(L)41cm*(DIA)4cm	Red Flash-Red Steady-Green Steady-Close
ST-900RB2	6+6pcs	(L)54cm*(DIA)4cm	Red Flash-Blue Flash-Close
ST-S900RB2	4+4pcs	(L)41cm*(DIA)4cm	Red Flash-Blue Flash-Close
ST-900RG2	6+6pcs	(L)54cm*(DIA)4cm	Red Flash-Green Flash-Close
ST-S900RG2	4+4pcs	(L)41cm*(DIA)4cm	Red Flash-Green Flash-Close





ST-9001R-AA ST-9001RG-AA



ST-M9002R-AA ST-M9002RG-AA



**Design Features**

Function: Multi flashing

LED colors can be chosen

Rechargeable function is available

**Specifications**

Visual Distance: More than 200 m

Flash Frequency: 3.3 Hz

Handle=ABS Pipe=PVC

Item No	LED number	Function	Size	Battery
ST-9001R-AA	6+1pcs	Flash-Steady-Top Lighting-Close+Whistle	(L)59cm*(DIA)4cm	3pcs size D Battery
ST-9001RG-AA	6+6+4+1pcs	Red Flash-Green Flash-Red and Green Flash in turn-Top Lighting-Red Laser Light-Close+Whistle	(L)59cm*(DIA)4cm	
ST-M9002R-AA	6+1pcs	Flash-Steady-Top Lighting-Close+Whistle+Magnet	(L)54cm*(DIA)4cm	3pcs size C Battery
ST-M9002RG-AA	6+6+4+1pcs	Red flash-Green Flash-Red and Green Flash in turn-Top Lighting-Red Laser Light-Close+Whistle+Magnet	(L)54cm*(DIA)4cm	





## ST-700 SERIES



ST-700RGW



ST-700Y



ST-700G



ST-700B



ST-700R



ST-L700R



ST-700R



ST-S700R

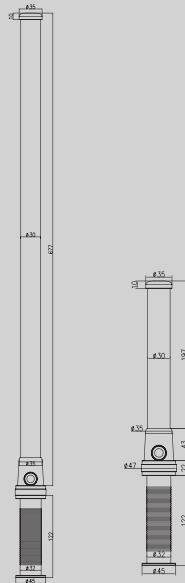

### Design Features

Function: Flash-Steady-Close.

Batteries: 2pcs C Battery

LED colors can be chosen

### Specifications

Visual Distance: More than 200 m

Flash Frequency: 4 Hz

Handle=ABS Pipe=PVC

Item No	Color	LED number	Size
ST-700 SERIES	R/G/B/Y	6pcs	(L)52cm*(DIA)3cm
ST-S700 SERIES	R/G/B/Y	4pcs	(L)40cm*(DIA)3cm
ST-L700 SERIES	R/G/B/Y	12pcs	(L)87cm*(DIA)3cm



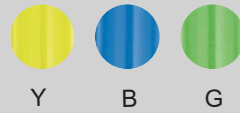

Function: Flash-Steady-White Light-Close.

Item No	Color	Size	LED number
ST-700R-1	R/G/B/Y	(L)52cm*(DIA)3cm	6+1pcs
ST-S700R-1	R/G/B/Y	(L)40cm*(DIA)3cm	4+1pcs

ST-700R-1 ST-S700R-1



ST-700RG2 ST-S700RG2



Item No	LED number	Size	Function
ST-700RB	6+6pcs	(L)52cm*(DIA)3cm	Red Flash-Red Steady-Blue Steady-Close
ST-S700RB	4+4pcs	(L)40cm*(DIA)3cm	Red Flash-Red Steady-Blue Steady-Close
ST-700RG	6+6pcs	(L)52cm*(DIA)3cm	Red Flash-Red Steady-Green Steady-Close
ST-S700RG	4+4pcs	(L)40cm*(DIA)3cm	Red Flash-Red Steady-Green Steady-Close
ST-700RB2	6+6pcs	(L)52cm*(DIA)3cm	Red Flash-Blue Flash-Close
ST-S700RB2	4+4pcs	(L)40cm*(DIA)3cm	Red Flash-Blue Flash-Close
ST-700RG2	6+6pcs	(L)52cm*(DIA)3cm	Red Flash-Green Flash-Close
ST-S700RG2	4+4pcs	(L)40cm*(DIA)3cm	Red Flash-Green Flash-Close



ST-700RAA-2

ST-700RAA-1

ST-S700RAA

ST-700RAA



Light for ST-700RAA-1

Light for ST-700RAA-2

### Design Features

LED colors can be chosen

700R-AA&S700R-AA with waist lamp

With iron buckle

### Specifications

Visual Distance: More than 200 m

Flash Frequency: 3.3 Hz

Handle=ABS Pipe=PVC

Item No	LED number	Function	Size	Battery
ST-700RAA	6pcs	Flash-Steady-Close +Harsh Warning	(L)55.5cm*(DIA)3cm	3 pcs size C Battery
ST-S700RAA	4pcs		(L)40cm*(DIA)3cm	2 pcs size C Battery
ST-700RAA-1	6+1pcs	Flash-Steady-Lighting(in the middle) -Close+Whistle	(L)55.5cm*(DIA)3cm	3pcs size C Battery
ST-700RAA-1	6+2pcs		(L)55.5cm*(DIA)3cm	





### 260 SERIES

Short baton in small size, used not only for traffic control, but also for extensive practicability in our daily life.

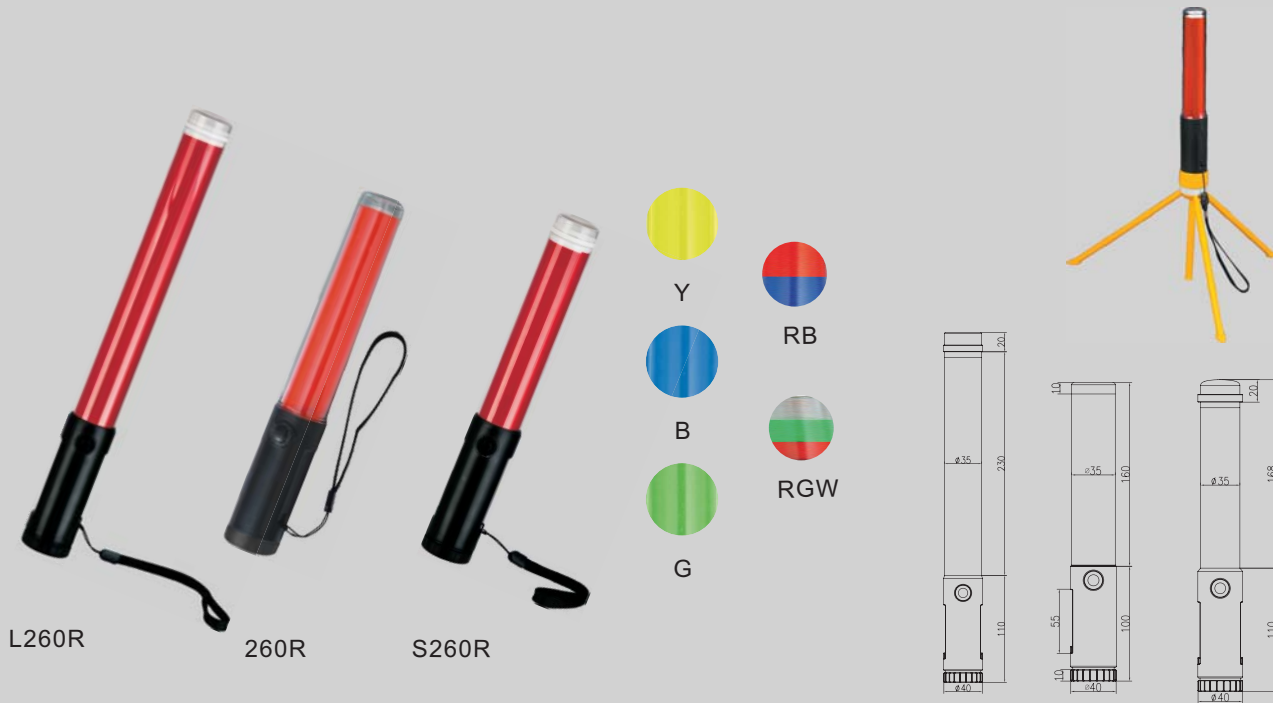

Design Features	Specifications
LED colors can be chosen	Visual Distance: More than 200 m
Function :Flash-Steady-Top Lighting-Close	Flash Frequency:3.3 Hz
With the magnet on the bottom	3 pcs AA battery
With a sling	Rechargeable function is available



Item No	Color	LED number	Material	Size
260 SERIES	R/G/B/Y/RB/RGW	18+1pcs	Handle:ABS Pipe:AS	(L)26cm*(DIA)4cm
S260 SERIES	R/G/B/Y	18+1pcs	Handle:ABS Pipe:PC	(L)26cm*(DIA)4cm
L260 SERIES	R/B/G/Y	18+1pcs	Handle:ABS Pipe:PC	(L)36cm*(DIA)4cm



L260R-AA 260R-AA

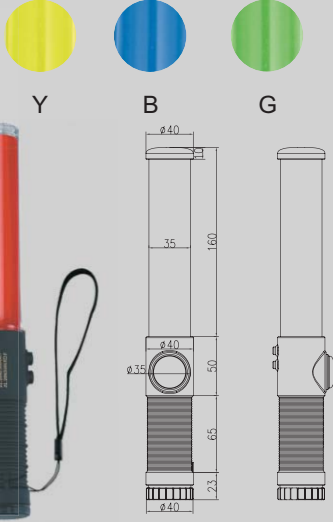

Function Video

Design Features	Specifications
LED colors can be chosen	Harsh warning function
Function:Flash-Steady-Top Lighting-Close	3 pcs AA Battery
With magnet on the bottom	LED number:18Red+1White

Item No	Color	Size	Material
260R-AA	R/G/B/Y	(L)30cm*(DIA)4cm	Handle:ABS Pipe:AS
L260R-AA	R/G/B/Y	(L)36cm*(DIA)4cm	Handle:ABS Pipe:PC



Function Video

Design Features	Specifications
Function:Multi flashing	Visual Distance:More than 200 m
With magnet on the bottom	Flash Frequency:5 Hz
Handle=ABS Pipe=PC	3 pcs AA Battery



L260RB6

Item No	Function	Size
L260RB6	Red Flash-Blue Flash-Red and Blue Flash in turn- Red and Blue Flash Together-Top Lighting-Close	(L)36cm*(DIA)4cm
L260RG6	Red Flash-Green Flash-Red and Green Flash in turn- Red and Green Flash Together-Top Lighting-Close	
L260RW6	Red Flash-White Flash-Red and White Flash in turn- Red and White Flash Together-Top Lighting-Close	

Function:Multi flashing	With magnet on the bottom
3 pcs AA Batteries	LED number:9Red+10Green



260RG

S260RG

L260RG

Item No	Material	Function	Size
260RG	Handle:ABS Pipe:AS	Red Flash-Red Steady- Green Steady-Close	(L)26cm*(DIA)4cm
S260RG	Handle:ABS Pipe:PC	Red Flash-Red Steady- Green Steady-Close	
L260RG	Handle:ABS Pipe:PC	Red Flash-Red Steady- Green Steady-Close	(L)36cm*(DIA)4cm



**250 SERIES**

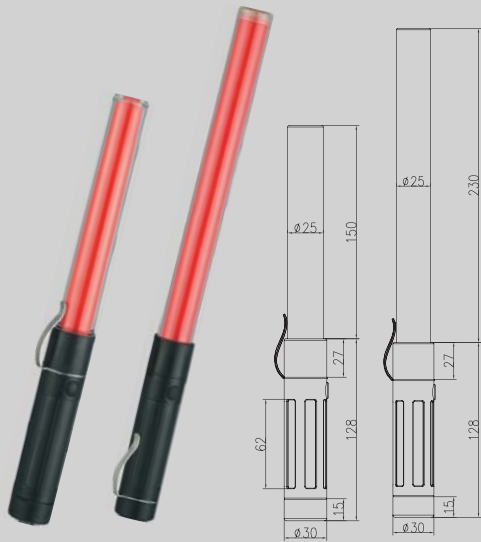

250R L250R



Design Features	Specifications
Function: Flash-Steady-Top Lighting-Close.	Material:Handle:ABS Pipe:AS
3 pcs AAA Battery	Flash Frequency:3.3 Hz
With magnet on the bottom	LED colors can be chosen
With an iron buckle	LED number:9+1pcs

Item No	Size	Color
250	(L)28cm*(DIA)3cm	R/G/B/Y/RB/RGW
L250	(L)36cm*(DIA)3cm	R/G/B/Y



L250RG 250RG

Design Features	Specifications
Function:Multi flashing	Material:Handle:ABS Pipe:AS
Batteries: 3 pcs AAA Battery	Flash Frequency:3.3 Hz
With magnet on the bottom	LED number:9Red+10Green

Item No	Size	Function
250RG	(L)28cm*(DIA)3cm	Red Flash-Red Steady-Green Steady-Close
L250RG	(L)36cm*(DIA)3cm	Red Flash-Red Steady-Green Steady-Close

### 270/280 SERIES



Function Video

LED colors can be chosen  
 Function:Flash-Steady-Close  
 Harsh warning function  
 Batteries:3 pcs AAA Battery

Item No	Size	Color	Magnet	LED Number	Function
270-AA		R/G/B/Y	N/A		Flash-Steady-Close
M270-AA	(L)26.5cm* (DIA)3.5cm	R/G/B/Y	With	19PCS	Flash-Steady-Close
M2701RG-AA		RG		4R+4G+4W +1Red Laser Light	Red and Green Flash in turn-Top Lighting -Red Laser Light-Close+Whistle

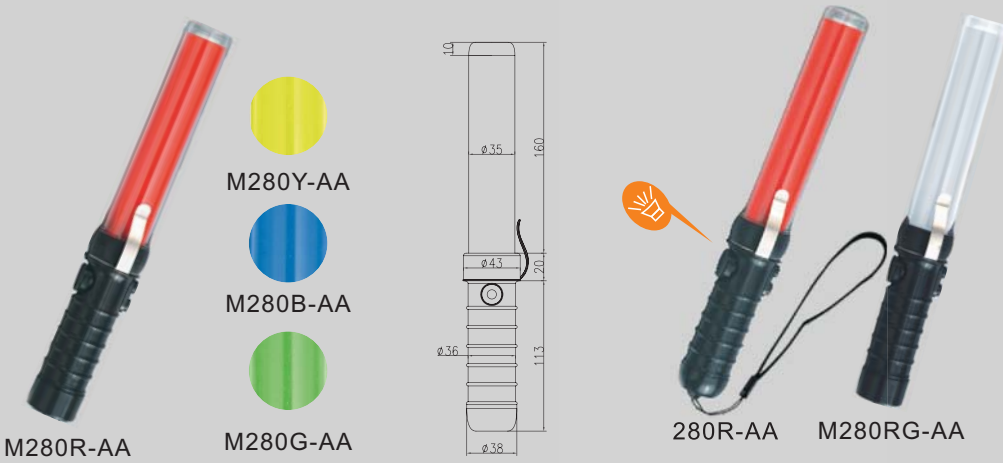

Function Video

Harsh warning function  
 Batteries:3 pcs AAA Battery  
 LED colors can be chosen  
 Function:Flash-Steady-Top Lighting-Close

Item No	Size	Color	Magnet	LED Number	Function
280-AA		R/G/B/Y	N/A		Flash-Steady-Top Lighting-Close
M280-AA	(L)30cm* (DIA)4cm	R/G/B/Y	With	18+1pcs	Flash-Steady-Top Lighting-Close
M280RG-AA		RG		9R+10G	Red Flash-Red Steady-Green Steady-Close



## AB-233 series

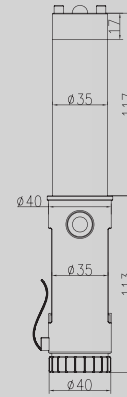

With magnet on the bottom

The top can be used for bumping

Batteries: 3 pcs AA Battery

Rechargeable function is available



Function Video

Item No	Size	LED Number	Function
AB-233RG		10pcs	Red Flash-Green Flash-Red and Green Flash in turn-Top Lighting-Red laser light-Close
AB-233RB	(L)36.5cm* (DIA)4cm	10pcs	Red Flash-Blue Flash-Red and Blue Flash in turn-Top lighting-red laser Light-Close
AB-233R		5pcs	Flash - Steady- Top Lighting- Close

## AB-273 series



- 1 In the middle: 10 red leds, flash-steady for SOS in the dark.  
On the top: 1 white leds, light in the dark.
- 2 Silicon rubber button, not damage easily
- 3 Magnet on the bottom can be attached on Iron.
- 4 It is more convenient to charge with the plug itself.
- 5 Function:Flash-Steady-White Light-Closed



AB-273 & AB-293  
Function Video

## AB-293 series

- 1 In the middle: 5 red leds, flash-steady for SOS in the dark.  
On the top: 1 white led, light in the dark.  
The top can be use to break window when trapped in the car
- 2 Loud whistle for SOS.
- 3 Non-slip handle, buckle and safety ring, easy to take.
- 4 Silicon rubber button, not damage easily
- 5 Independent switches, whistle and flash/light are not affected by each other.
- 7 Magnet on the bottom can be attached on Iron.
- 8 Rubber ring, water proof.
- 9 Function:Flash-Steady-Lighting-Close

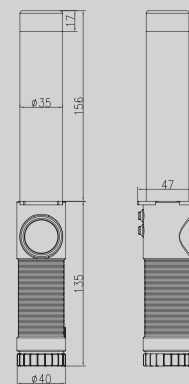

AB-293

## EXPANDABLE BATON SERIES



ST-43-65

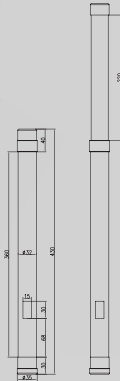

Product model:ST-43-65  
 1. Function:Flash-Steady-Top Lighting-Close.  
 2. LED number:6red +1white  
 3. Size:(L)43/65cm\*(DIA)3cm  
 4. With a sling.  
 5. Firm stainless steel hull can be used for self-protection.  
 6. Pipe: PC material.  
 7. 3 pcs AAA battery.

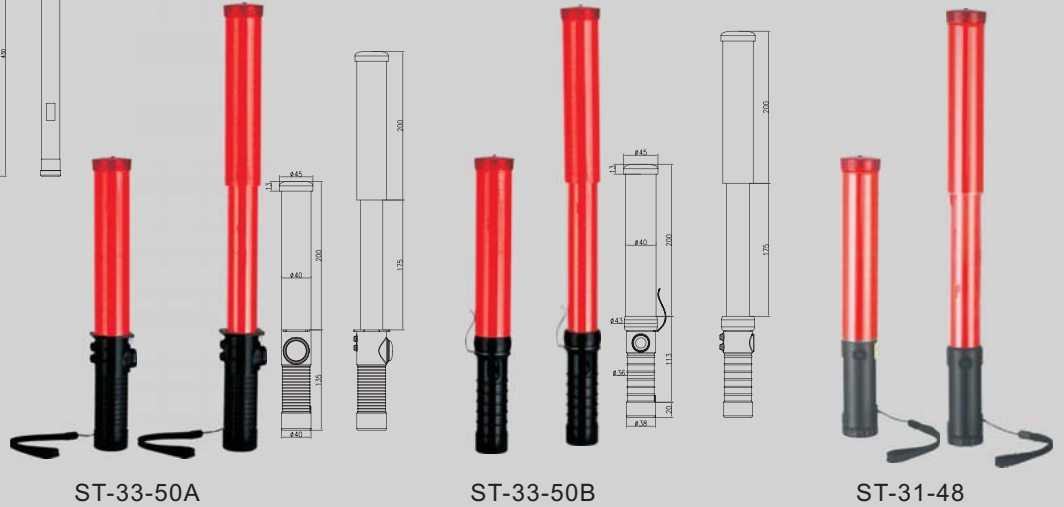

ST-33-50A

ST-33-50B

ST-31-48

With magnet on the bottom

Diameter:4.5cm

Led number:6pcs +1pc(waist lamp)

Function:Flash-Steady-Lighting(waist)-Close.

Item No	Size	Function	Batteries	Accessory
ST-33-50AA	(L)50/33.5cm	Whistle	3 pcs AA battery	Sling
ST-33-50B		Harsh Warning	3 pcs AAA battery	Iron Buckle
ST-31-48	(L)48/31cm		3 pcs AA battery	Sling

## ST-510AA



ST-510AA

510AA traffic baton is mainly used by police man as police stick. Its hull is made of stainless steel and firm enough for self-defense tool. Loud alarm can attract the people's attention easily.

Size:(L)51cm\*(DIA)3cm

With a sling

Function:Top Lighting-Close+Whistle

Visual Distance:More than 200m

3 pcs AAA Battery

Stainless steel pipe



ST-211AA



Yellow



Black



Red

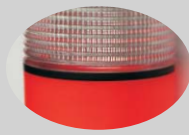
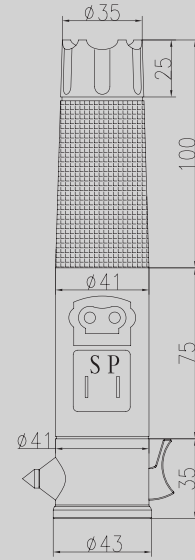

Rubber ring, water proof.

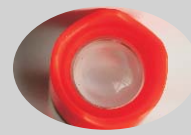

On the top: 1 white LED, flashing in the dark.

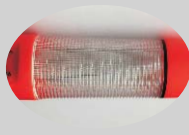

In the middle: Flashing red Light Warning  
3 red LEDs, flashing for SOS in the dark.



Independent buttons: Light/Beacon/Alarm.



Loud whistle for SOS.



If accident occurs and cannot open the window,  
use the pointed hammer to break it up.



If accident occurs and stocked on the safety  
belt, use the reamer to cut it out.



Magnet on the bottom can be attached on Iron.



AB-SU64

It can be charge by the sunlight

Includes High-Bright LED lamp

Environment-Protection and cost savings by solar energy

Even if the solar energy is not enough to charge the battery, it can also recharge on AC.

Reduce 40% weight, handy even for long time usage

Length can be change according to requirements

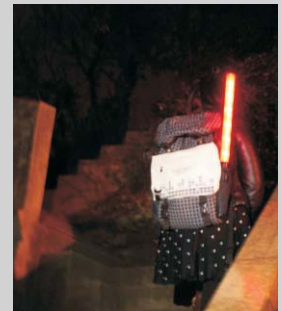

Item No	Solar cell	Function	LED number	Battery
AB-SU64	5V/100mA	Flash-Lighting	6+3pcs	Two 3.2V 1200mAh Lithium battery
AB-SU118-220	5V/100mA	Flash-Lighting	16+3pcs	Two 3.2V 1200mAh Lithium battery

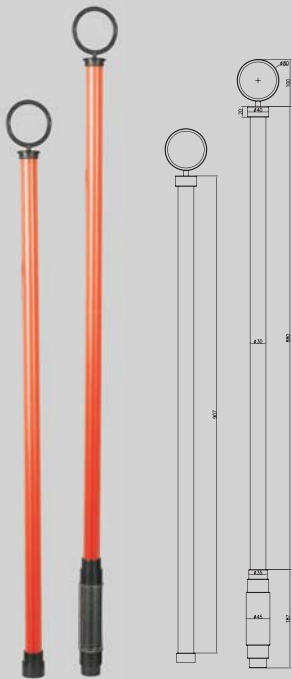

AB-SU118-220

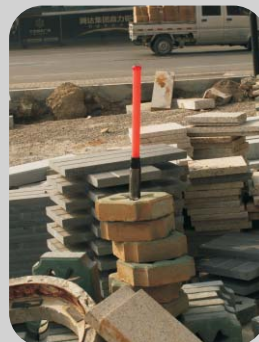

## AB-1230/1800 SERIES



Two mounting methods:magnet/screw

500 times charge-discharge

Material:PC Hull+ABS base

Water-proof design

Item No	Size	Function	LED number	Power
AB-SU1230Y/R	12.3*10cm	Flash	6Yellow/Red	Solar panel:5V 70mA Storage battery:2pcs 3.2V lithium battery
AB-SU1230RB	12.3*10cm	Red and Blue Flash in turn	3Red+3Blue	Solar panel:5V 70mA Storage battery:2pcs 3.2V lithium battery
AB-SU1800R/Y	18*14cm	Flash	8Red/Yellow	Solar panel:5V 160mA Storage battery:2pcs 3.2V lithium battery
AB-SU1800RB	18*14cm	Red and Blue Flash in turn	8Red+8Blue	Solar panel:5V 160mA Storage battery:2pcs 3.2V lithium battery
AB-1230R/Y	12.3*10cm	Flash	15Red/Yellow	DC 12V/24V/12-24V
AB-1800R/Y	18*14cm	Flash	30Red/Yellow	DC 12V/24V AC 110V/220V12-24V



Function Video

## Post Topper AB-SU1130



AB-SU1130R

Material: Top:PVC Base:ABS  
Size: Dia.123\*113mm  
Lighting Mode:Flashing or 4Quad Flash-Close  
LED:Φ5 6pcs  
Solar Panel : 5V 69mA

### Features:

1. With hull can be easily fixed on any of the warning post, easy operation and hard to be pull out.
2. Solar type ,no batteries required, maintenance free.
3. Water proof IP56,with silicon rubber button switch inside



Function Video



### AB-1150 SERIES

AB-1150 series is a advanced SOLAR LED BEACON with 64pcs super bright led bulb. It was designed with an internal switch, water proof resistant, and a magnetic bottom.

It can use in transportation maintenance, safety marking, coast, park, channel, fence, tower, cruise, road warnings and so on.



AB-1150R

Easy operation and water-proof

With magnet on the bottom

Built-in switch for multiple function

64pcs Super-bright LEDs

Three Function

Item No	Size	LED Number	Material	Power	Flash
AB-1150	115*(D)115mm	64pcs	PC Hull+ ABS Base	DC 12V/24V/12-24V	4Quad Flash-Flash-Rotation Flash



Magnetic Bottom

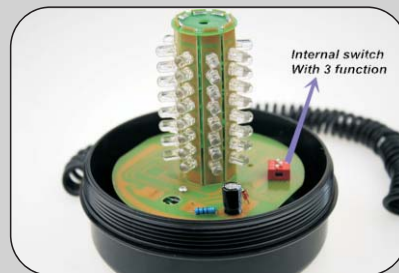

Internal switch





This series of LED Beacons are the most advanced LED Lights, they are waterproof & shock resistant and with 3 functions, FLASH - 4 QUAD FLASH - ROTATING FLASH - CLOSED  
 Made of PC material & Equipped with 80pcs super bright LED (56pcs LED for Rechargeable type )

	Rechargeable (3pcs batteries) ABS Base	With Car Charger ABS Base	Wired ABS Base	Wired Aluminum Base	With car charger Aluminum Base
<b>AB-1350</b> Height 13cm					
	AB-1350-RE (56pcs LED)	AB-1350-DC (80pcs LED)	AB-1350 (80pcs LED)	AB-AL1350 (60pcs LED)	AB-AL1350-DC (60pcs LED)
<b>AB-1650</b> Height 15.5cm					
	AB-1650-RE (56pcs LED)	AB-1650-DC (100pcs LED)	AB-1650 (100pcs LED)	AB-AL1650 (100pcs LED)	AB-AL1650-DC (100pcs LED)

1. Wide voltage (12v and 24v) is optional (Voltage of ordinary type is 12v or 24v)
2. High quality car charger--With thicker cable & a switch on the charger that can be used to adjust beacon's working modes



Standard car charger



High quality car charger

3. Different installation methods for ABS & AL (Aluminum alloy) bases

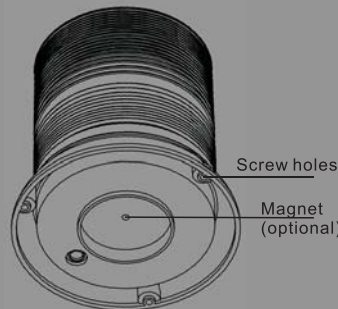

ABS Base -  
Magnet (optional) & screw holes  
at the base

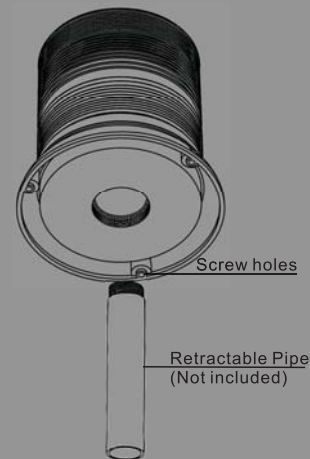

AL Base -  
Retractable Pipe (Not included) & screw holes  
at the base

4. Magnetic Rubber Suction Cup is optional  
 It's suitable for both ABS & AL bases (Except for the rechargeable type), being installed by using 3pcs screws.  
 With 3pcs strong Magnets inside & being protected by Rubber Suction Cup (the RSC is windproof & waterproof & can firmly adsorb on the iron surface), making sure that even driving speed is over 120km/h, the beacon will not fly out of the car



Magnetic Rubber Suction Cup

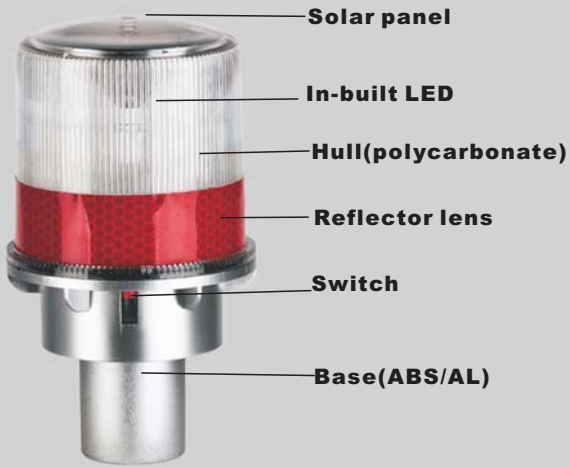

Item NO.: AB-SU156  
 1.4pcs ultra bright LED  
 2.Flash-close/Flash-steady-close  
 3.Photocontrol:off in daylight and flash in night automatically  
 4.built-in silver gilt cup, increase the light scope  
 5.Applications: mounted to walls, barricades, rubber traffic cones, signs and poles. Use during road construction and signal safety hazards on build sites, in warehouses, airports, etc.

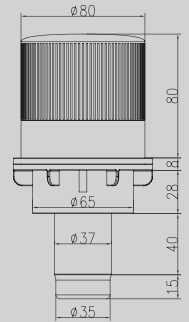
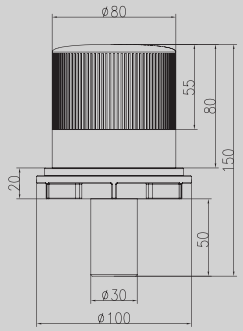
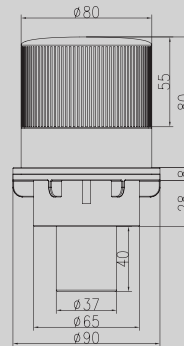
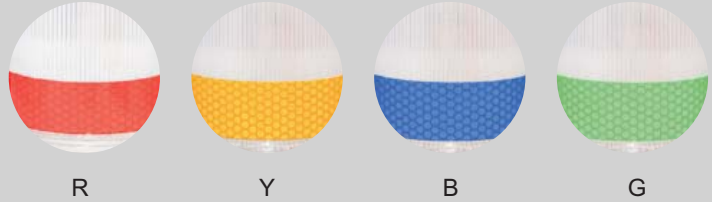





The special double lock design of base for Japan market, which can firmly fix on the cone with matched cone connector.



AB-SU156J

- Item NO.: AB-SU156J
1. 4pcs ultra bright LED
  2. Battery: 600mAh rechargeable batteries
  3. Photocontrol: off in daylight and flash in night automatically
  4. Material: PVC lens, ABS base
  5. Product size:  $\Phi 80 \times 174$ mm
  6. 360 degrees lens for all round light visibility
  7. Water proof, it can work in the rainy day



AB-SU153J

- Item NO.: AB-SU153J
1. 2pcs of red+ 2pcs of green(4pcs of red)
  2. Battery: 600mAh rechargeable batteries
  3. Photocontrol: off in daylight and flash in night automatically
  4. Material: PC lens, ABS base
  5. Product size:  $\Phi 71 \times 153$ mm
  6. 360 degrees lens for all round light visibility
  7. Water proof, it can work in the rainy day



T-JP

- Item NO.: T-JP
- Top diameter: 4cm  
Bottom diameter: 9.6cm  
Height: 19.2cm





## Mini Solar Cone Topper AB-SU830

Good ability of anti-theft	Attractive on the motorists
Fast mounted for cones	Automatic light control

AB-SU830	
Material	PC Material Red Lens
Size	Dia.85*60mm
Lighting Mode	Flashing or 4Quad Flash-Close
LED Quantity	4pcs
Color	Red/Yellow/Blue/Clear
Battery	3.2V 600mAh
Solar Panel	60mA 4V



AB-SU830R

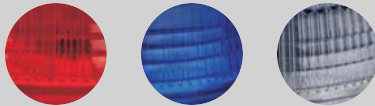

Waterproof plug



Switch

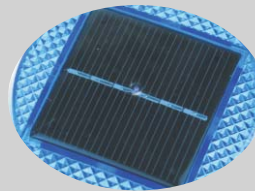

Solar Pannel

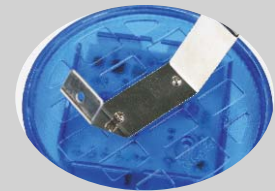

Stainless



### Features:

The MINI SOLAR CONE TOPPER LIGHT can easily get the attention of the motorists to be aware and cautious while reaching the road construction and repairs, road closures, detours and so on. It has 4LEDs and frequently flashing for 60 times per minute.

The mini solar cone topper have a internal solar panel attached on the upper lens with various electrical components, further more, the spring clamp on the bottom have a super anti-theft function.

## Mini Battery Operated Cone Topper AB-180

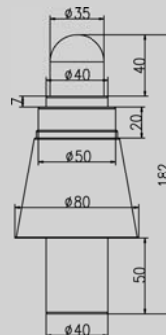

1pcs ultra bright LED

Size:(H)18cm\*(Dia)8cm

Battery: Two D

Function: Flash-Close

Automatic light control, on at dusk, off at dawn

**WL-A31-001 SERIES**



Super Bright LED Lamp

Inflating Nozzle

Multi-function Button



WL-A31-001

Easily to Carry

PVC Shell

Efficient Solar Panel

Name: inflatable solar lantern  
 Diameter:5 Height collapsed:1 Height inflated:4  
 Solar Panel:5V/120MA  
 Battery:3.7V/1000MAH  
 Material/ Accessory : Waterproof PVC enclosure and PCB board/  
 poly-Si or single crystal silicon in solar battery board as Energy Sources /pump  
 Charging Time:6-8h  
 Lighting Time: full bright:4-5h half bright: 9- 10h flash: over 10h  
 Apply with photovoltaic technology  
 Working Life: Available for 6 years in normal use with solar battery  
 Operating Temperature: -10℃—+85℃ ;

**AB-B5 SERIES**



AB-B5

Material: PS+ABS  
 Battery: 2 pcs of AG13 button cell  
 Any logo can be printed  
 Size: Dia 48mm Thickness 14.5mm  
 Function:Flash-Close



## AB-1020/1030/1507/1508 SERIES

Photocontrol	Magnetic bottom
Super-bright LEDs	Water proof

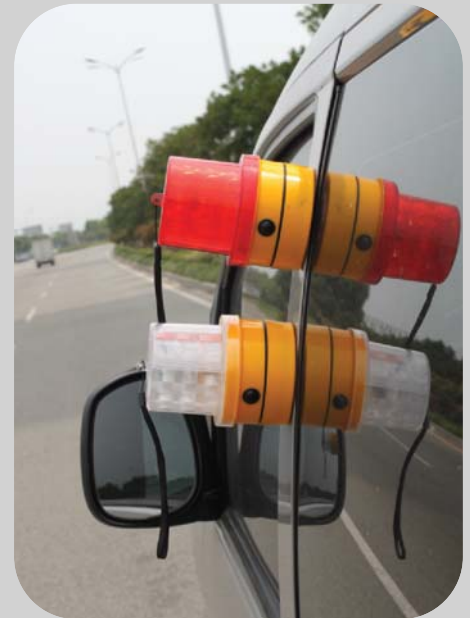

AB-1020Y



AB-1020RB



AB-1030G



AB-1030Y



AB-1030B



AB-1020R

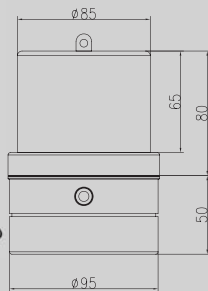

AB-1030R

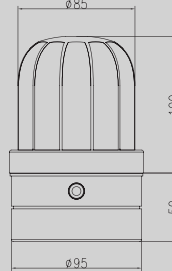

AB-1507R



AB-1507Y



AB-1507RB

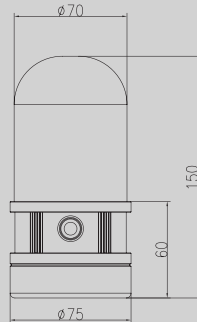

AB-1508Y

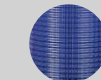

AB-1508B



AB-1508R



AB-1508RB

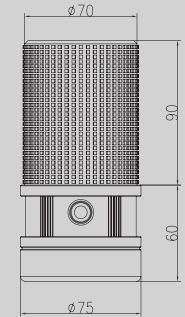

Item No	Color	LED number	Function	Size	Battery
AB-1020	R/Y	8PCS	Flash	(H)13cm*(DIA)9.5cm	Two D
AB-1020RB	RB	8Red+8Blue	Red and Blue Flash in turn	(H)13cm*(DIA)9.5cm	Two D
AB-1030	R/B/G/Y	6PCS	Flash	(H)14.5cm*(DIA)9.5cm	Two D
AB-1507	R/B/G/Y	4PCS	Flash	(H)15cm*(DIA)7cm	Three AA
AB-1507RB	RB	3Red+3Blue	Red and Blue Flash in turn	(H)15cm*(DIA)7cm	Three AA
AB-1508	R/B/G/Y	4PCS	Flash	(H)15cm*(DIA)7cm	Three AA
AB-1508RB	RB	3Red+3Blue	Red and Blue Flash in turn	(H)15cm*(DIA)7cm	Three AA



## AB-1030/1507/1508 NEW SERIES

Magnetic Bottom that can be firmly attach in the body of the car

LED color can be chosen



AB-1030-2

Size:(H)14.5CM\*(D)9.5CM

Item No	Color	Function	LED number
AB-1030-1	R/Y/B/G	Flash Together	30pcs
AB-1030-2	R/Y/B/G	Rotating Flash	30pcs



AB-1507-1



AB-1507-4

Size:(H)15CM\*(D)7CM

Item No	Color	Function	LED number
AB-1507-1	R/Y	Flash Together	20pcs
AB-1507-2	R/Y	Rotating Flash	20pcs
AB-1507-3	R/Y	4 Quad Flash	30pcs
AB-1507-4	Red and Blue	Red and Blue Flash in turn	30pcs

Size:(H)15CM\*(D)7CM

Item No	Color	Function	LED number
AB-1508-1	R/Y/B	Flash Together	20pcs
AB-1508-2	R/Y/B	Rotating Flash	20pcs
AB-1508-3	R/Y/B	4 Quad Flash	30pcs
AB-1508-4	Red and Blue	Red and Blue Flash in turn	30pcs



AB-1508-1



AB-1508-4



## AB-1720 SERIES



AB-1720

- 48pcs LED for super bright
- Install conveniently
- Waterproof/Windproof/Dustproof
- Provide 360° vision
- Fit on 4cm pole
- Rechargeable

Item No	Size	LED Number	Material	Power	Flash
AB-1720	1720*120mm	24pcs red+24pcs blue	Shell PC+Base ABS	Rechargeable Li-batteries	Red and blue flash in ture



### FEATURES :

- PC Shell + ABS base
- Working hours: 50 hours
- Function: Red and Blue flash in turn
- Utilizing the latest technology, optical design and flashing patterns
- LED numbers:24red+24blue
- Rechargeable hole on the bottom and covered with a waterproof cap.
- Fix on the pole; to be cone light with connecting accessories

### APPLICATIONS :

- Identifies First Aid and Rescue Equipment locations
- Caution traffic markers for special events
- Portable markers for cranes, towers and booms
- Marks danger zones, disabled vehicles, etc.
- Security Alerts



### AB-9R



AB-9R

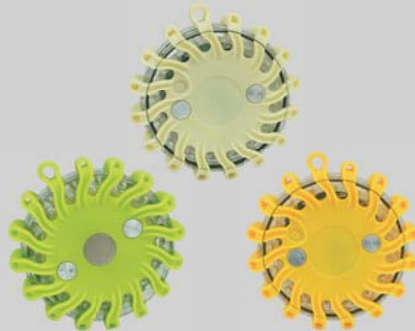

Function Video

- Material:TPE+PC.
- With strong magnet base.
- Size:Diameter 11cm,Height:3.5cm.
- With one AC charger and one car charger.
- 16 Super bright LEDs
- Lighting distance: ½ mile.

- Lifespan is more than 100,000 hours.
- Function: 9 kind of flashing.
- Weight:187g.
- Color: red, yellow blue, green, white and black.
- Working temp: --40 degree ---- + 60 degree
- Easy installation, no maintenance

### WL-A26-001



WL-A26-001



Function Video

### WL-A26-001

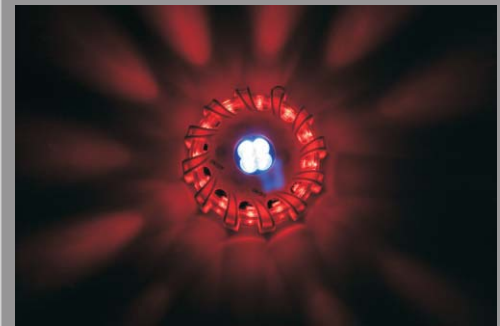

- Material:TPE+PC.
- With strong magnet base.
- Size:Diameter 11cm,Height:4.2cm.
- 3 pcs AAA batteries
- 16 Super bright LEDs
- Lighting distance: ½ mile.

- Lifespan is more than 100,000 hours.
- Function: 9 kind of flashing, and flashlight.
- Weight:176g.
- Color: red, yellow blue, green, white and black.
- Working temp: --40 degree ---- + 60 degree
- Easy installation, no maintenance

### WL-A26-003



WL-A26-003



Function Video

- Material: TPR+PC.
- with strong magnet base.
- Size:Diameter 10cm,Height:3.5cm.
- 12+3 Super bright LEDs
- Lighting distance: 900meters in the dark.
- Lifespan is more than 100,000 hours.
- Function: 9 kind of flashing..
- Weight:190g including battery.
- Color: red, yellow blue, green, white and amber.
- Working temp: --40 degree ---- + 100 degree
- Easy installation, no maintenance

## AB-196

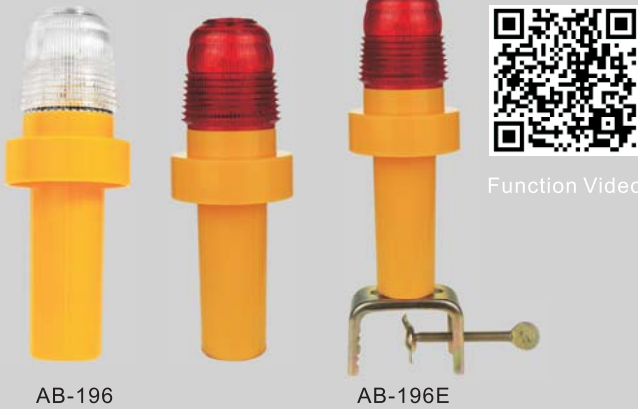

AB-196

AB-196E

Function Video



1. Material: Shell: PC. Handle: ABS
2. Size: Diameter: max: 7cm, min: 4cm Height: 20cm.
3. 2pcs D batteries.
4. Transparent plastic shell with 6pcs super bright LEDs
5. Lighting distance: more than 800M
6. Lifespan is more than 100,000 hours.
7. Function: 4Quad flash.
8. G. W. /N. W. (KG) : 9. 5/7. 5.
9. Packing: 50pcs/carton, meas: 39. 5\*39. 5\*43cm
10. Color: red/blue/green/yellow

## WL-A26-002



WL-A26-002

Function Video



Item NO.:WL-A26-002  
 Material:shell Polymer and lampshade lens PC  
 Power supply:3pcs AAA Batteries  
 LED QTY:9PCS  
 Available in three colors: red ,yellow and white,blue green.  
 Mode: Flash-Constant-close

Flash rate: 60 times /minute  
 Flash frequency: 1.5 Hz  
 Weight:100g without battery  
 Visual Distance:≥1500 meter  
 Size:12cm diameter/20cm high  
 Avery Power Consumption: 6.5mAH

## WL-A48-001



WL-A48-001

Function Video

Size:Height45xDia.80mm  
 Weight:95g(112g with batteries)  
 Powered by 3xAAA batteries  
 Run-time:Steady/Flash mode 20/60hrs  
 Powerful magnet base  
 Super bright 360° visibility  
 0.5Watt LED with50,000hrs life  
 Rugged crush & water-proof  
 Compact,Durable,Safe





AB – SU1500 is intergrated designed, enabling a rugged and completely waterproof , It is widely used for the marine industry, airports, telecommunication towers, construction cranes, inland waterways and emergency demarcation.



AB-SU1500



AB-SUM1500



- Product size:(H)13cm\*(D)15cm
- 8pcs of super bright LEDs
- With 2pcs of 1.2V Ni-Mh Batteries.
- Function: Flash.
- Extremely reliable and cost saving.
- With bird pike(AB-SU1500 series).

- PC hull material.
- Monocrystalline silicon solar module type, with 4V,160MA,0.64W.
- Water proof.
- beacon light with photocell and manual switch.
- 4 holes on base which you can fixed by screws.
- With magnet(AB-SUM1500 series).



ST-SAL-002AC



ST-SAL-002



ST-SAL-002M



- Product size:(H)29cm\*(D)16cm
- 8pcs of super bright LEDs
- With 3.7v 6Ah /With 2pcs of 1.2V Ni-Mh Batteries
- Function: Flash.
- High efficiency solar panels, the working is 100h
- Color: Red/ Amber /White

- PC hull, ABS base material.
- Monocrystalline solar panel, with 4.8v 630MA,3W /4V,160MA,0.64W
- Waterproof IP65, can be used in rain
- Light control: off in daylight and flash in night automatically
- Convenient to use, photo control with photocell and manual switch.
- With magnet(ST-SAL-002M series).



ST-SAL-001AC



ST-SAL-001



ST-SAL-003AC



ST-SAL-003



ST-SAL-004



- PC hull, ABS base material.
- Monocrystalline solar panel, with 4.8v 630MA,3W
- With 3.7v 6AhNi-Mh Batteries
- Color: Red/ Amber /White
- Waterproof IP65, can be used in rain
- Flash Frequency:20~60 times per minute
- High efficiency solar panels, the working is 100h
- Light control: off in daylight and flash in night automatically
- Convenient to use, photo control with photocell and manual switch.

Item No	Size	LED Number	Function
ST-SAL-001	(H)34cm*(D)15cm	30pcs of ultra bright LEDs	Flash
ST-SAL-003	(H)26.5cm*(D)14cm	56pcs of ultra bright LEDs	Rotating Flash
ST-SAL-004	(H)26.5cm*(D)14cm	24pcs of ultra bright LEDs	Steady

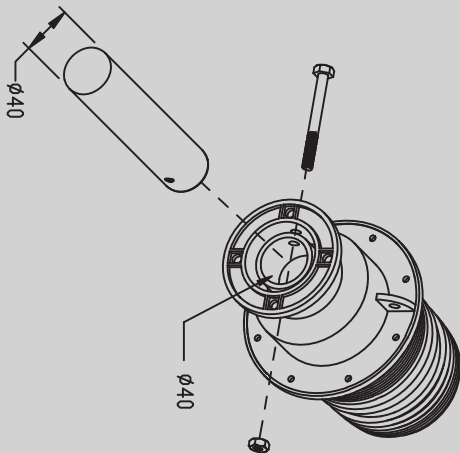

Fit 40mm diameter pole

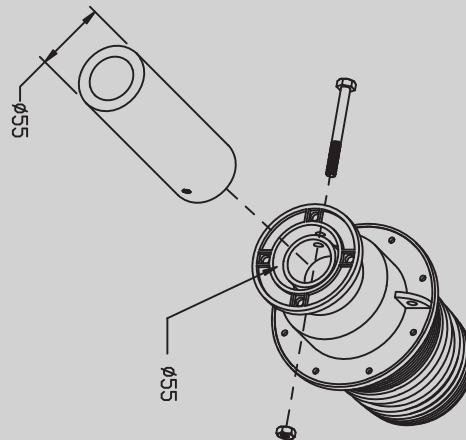

Fit 55mm diameter hollow-rod

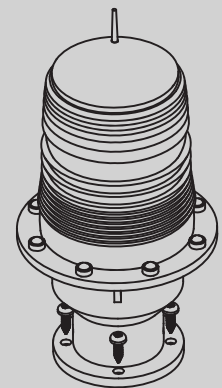

Fixed with 4 screws



SP-ETB-001, the new design of plastic expandable barrier from Stars Plastic. It can fit some of Stars Plastic products, such as Traffic Batons and Barricade Light Transformer Series. Triangle base, also water and sand can be filled in to make it more stable.



SP-ETB-001

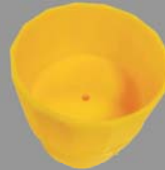

DIA:4CM  
Fit to traffic baton  
handheld warning light



DIA : 3CM  
Fit to Transformer series warning light

Item No	Size	Weight	Fill Water Weight	Material	Scalable Systems
SP-ETB-001	950*370*200mm	2.3KG	5.3KG	PE	200-1900mm /200-2100mm

### Features:

- Quick Easy Set-up.
- Easy Carry and Storage.
- Built-in Slots for Safety Tape.
- Exceptional Visibility, Optional Reflector Units Available
- Two types of special designed Caps for the water inlets, fit with our batons or Transformer series Warning Lights.
- Can extend to 1.9m. Can fill with water
- Two methods of packing: Assembled & non-assembled  
Assembled: 120\*39\*43cm/4sets(560sets/20')  
Non-assembled: 95\*39\*43cm/4sets(700sets/20')

### Fitting List:

Screw Cap:  
Transformer Series(AB-SU309,AB-SU310,AB-SU311.  
and so on)

Non-screw Cap:  
260 series, 293 series, 280 series, 265 series, 220 series,  
305 series, and so on



AB-140





AS-A27-001



AS-A27-002



T-N



T-M



T-R



T-JP



FI-A41-001



FI-A41-002



Put corresponding tools which diameter is 4CM

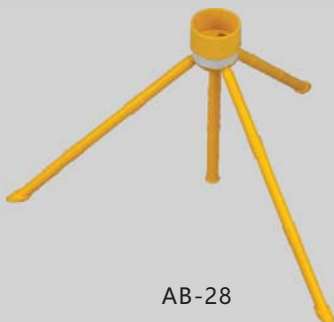

AB-28



AB-29



AB-75

Put corresponding tools which diameter is 4CM



AB-35







Stars Plastic Work Shop



Stars Plastic Sample Room



Stars Plastic Electronic Part Warehouse



Stars Plastic Product Warehouse

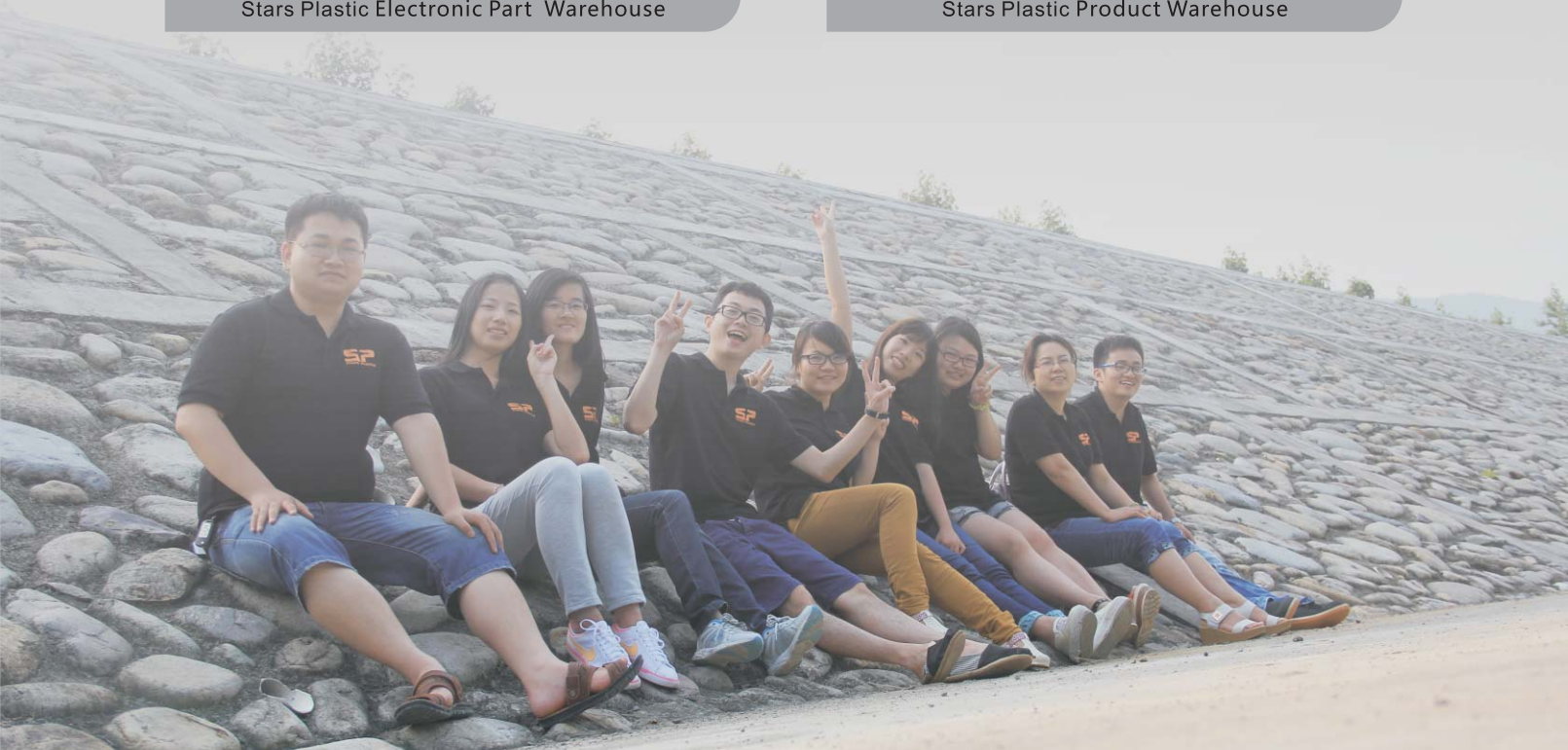



**MAKE SAFETY EASIER**

**PROFESSIONAL SAFETY PRODUCTS MANUFACTURER**



FACEBOOK



YOUTUBE

**TAIZHOU STARS PLASTIC SAFETY DEVICE CO.,LTD**

ADD:No.575 JINGYI ROAD, JIAOJIANG AREA, TAIZHOU, ZHEJIANG CHINA

**Foreign Trade Department**

OVERSEA SALES OFFICE:9TH FLOOR, TIANSHI BUILDING

WEST LUQIAO AVENUE, LUQIAO AREA, TAIZHOU, ZHEJIANG CHINA

Tel:0086-576-82383999 80230333 Fax:0086-576-80230222

P.C:318050

Http://www.starsplastic.com

E-mail:sales@starsplastic.com

**台州市中星安全设施有限公司**

地址：中国浙江省台州市椒江经一路575号

**内贸部Domestic Trade Department**

电话：0086-576-82424666 82424689 82424699

传真：0086-576- 82424770

邮编：318000

Http://www.starsplastic.cn

E-mail:sales@starsplastic.com