



# EBAAL CATALOG

## 宜贝产品目录

节能环保卷帘门窗  
Energy saving roller shutter  
doors and window



# Summary

Motoriduttori E Accessori–Rohr–Motoren Und Zubehör Tubular Motors and Accessories–管状电机及配件	<b>1</b>
Awolgitori, Guidacinghia, Rullini Di Rinvio, ecc.–Gurtwickler, Gurfführungen, Abdruckrollen, usw. Strap Coilers, Strap Guides, Guide Rollers, etc–收绕器, 导轮系列	<b>35</b>
Supporti "Torino", "Napoli", ecc.–Unterstützung metalic Supports–意式金属配件系列	<b>55</b>
Rulli E Accessori–Achtkantwellen Und Zubehör Oct Tubes and Accessories–八角管及附件	<b>62</b>
Fianchi E Profili In Alluminio, Cassonetto, Accessori, ecc.– Blendkappen Und Profile, Aluminium Kasten, Zubehör, usw.	<b>66</b>
Cuscinetti-Lager Und Kugellager Bearings–轴承系列	<b>84</b>
Supporti Per Cuscinetti-Unterstützung Für Lager Und Kugellager Bearing Brackets & Supports–轴承支架系列	<b>87</b>
Callota In Plastica/Ferro/Alluminio-Kunststoff/Stahl/Aluminium Kapsel Plastic/Ststeel/Aluminum Caps–塑料/金属八角帽, 尾插等	<b>91</b>
Pulegge In Plastica/Ferro-Kunststoff/Stahl Gurtscheiben plastic/Ststeel Pulleys–轮盘系列	<b>99</b>
Argani E Accessori-Getriebe Und Zubehör Reduction Winches and Accessories–减速驱动盘系列	<b>102</b>
Snodo E Accessori-kreuzgelenk Und Zubehör Cardan Joints and Accessories–万向节系列	<b>109</b>
Asta Plastificata E Accessori-Plastifizierte Kurbelstange Und Zubehör Handcranks and Accessories–手摇杆系列	<b>121</b>
Molle Di Sicurezza-Sicherungsfedern Security Springs/Hangers–挂条系列	<b>125</b>
Euroblock, Superblock, Alutank, Miniblock E Accessori-Euroblock, Superblock, Alutank, Miniblock Und Zubehör Euroblock, Superblock, Alutank, Miniblock and Adaptors–防上推及附件系列	<b>130</b>
Cintino, Cordone, Kit di riparazione per Cintino, ecc.–Gurt, Schnur, Und Reparaturset Für Gurt, Usw. Straps, Cords and Strap Repairing Kits–织带及织带修补配件	<b>139</b>
Altri accessori Per Avvogibili-Andere Teile Und Zubehör Für Rollladen Other Accessories Roller Shutters–其它卷帘配件	<b>141</b>



## 公司简介 Company profile

中山宜贝是专门研发、生产、销售铝合金卷帘及配件的实体企业。

公司于2006年成立并通过ISO 9001:2008质量体系认证，拥有先进塑料、五金产品生产设备，20年专注于研发的资深工程师为客户研制高品质的产品。在十几年的研发、生产过程中积累了丰富的生产和管理经验，培养了一支技术精湛，讲信誉，重质量的员工队伍，确保产品的品质超过客户的要求。我们的产品远销国内外，主要销售国家有德国，美国，澳大利亚，约旦等。公司一贯宗旨“良心做产品，服务全世界”，我们会以高品质的产品满足客户的需求。

Yeaby is a professional company specialized in designing, producing and selling aluminum roller shutter and accessories .It was founded in 2006 and had obtained ISO9001:2008 certification .Our company have advanced production equipment for plastic and metal products.The engineer at Yeaby has over 20 years experience with products design and development. They can achieve customer' s special requirements and solve the problem their faced in the production process The highest quality raw materials are imported from Germany. And finished roller shutter and accessories are mainly exported to Germany, the United States, Australia, Ireland,Jordan, etc.We consist on the principle “superior-quality product,serving the world” ,we will provide high quality products to meet the customers' requirements.



▶ Open The Way  
开启方式

中山宜贝节能技术有限公司是一家从事环保节能的增长型高科技创新公司，主要致力于家庭用产品的创新开发、生产和销售一站式服务。  
主要产品：欧式卷帘窗、欧式卷帘门、车库门等环保节能产品，同时兼顾一些五金塑胶制品的设计、生产和销售。

Wire Drive



A. 线控驱动，操作和其他电器开关一样非常容易，在居室智能化的今天，该操作可直接实现单控、层控、组控、总控、及时控，并可直接配合智能家居系统使用。

Wire Remote Drive



B. 无线遥控，在室内可以轻松控制

Portable R/C



C. 无线遥控，在室外可以轻松控制车库门

## ▶ Indoor Effect 室内效果



### ▶ 家居系列 Home Series

室内效果 / Indoor effect  
户外效果 / Outdoor effect  
车库效果 / Garage effect

## ▶ Open The Way 开启方式



### 皮带驱动 BELT DRIVE

易操作，经济实用，占用空间较小。手拉皮带采用高品质尼龙绳，寿命更长；且可搭配省力装置，整体操作更加人性化；可操作4平方米以下的卷帘窗。

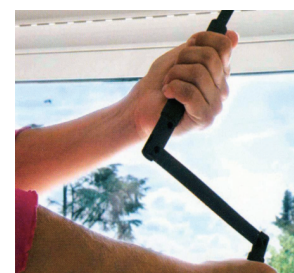

### 曲柄驱动 CRANK DRIVE

易操作，尺寸按人体工程学比例设计；手摇齿轮箱的增强性设计，较其他产品，更加减少摩擦，整体寿命更加延长，省力；可操作卷帘窗面积在8平方米以下。

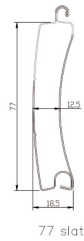
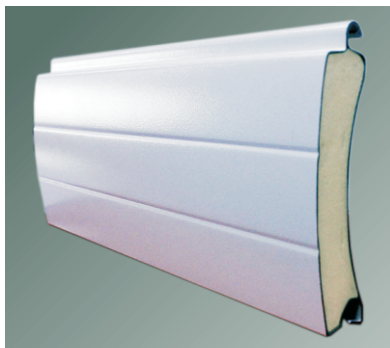

### 77mm Aluminum Slat

Weight: 3.55 kg/m<sup>2</sup>

0.32mm

PU density: 60kg/M3

Material: Alu3005 & PU foam

Production length: 5.8M or 6M

Quantity per package: 58 meter

No. of slats per meter: 12.9pcs

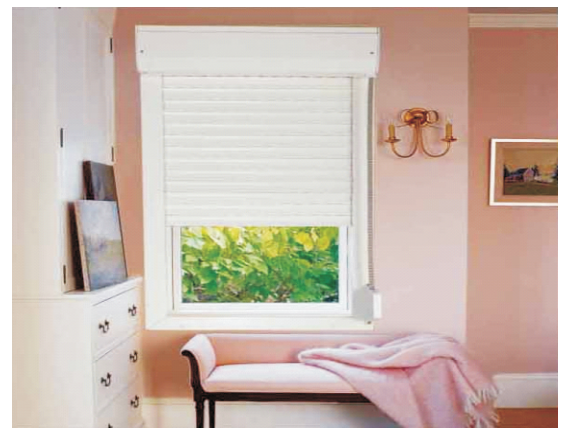

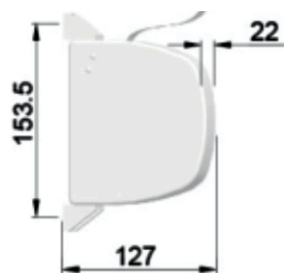

Avvolgitore a bandiera con/per cintino  
Mini-Gurtwickler Mit/fÜR Gurt  
Strap Coiler  
带式收绕盒

Articolo-Artikel	IL Colore-Farbe	Cintino-Gurt
Art.No.-编号	Colour-颜色	Strap-织带
	bianco-weiss-white-白色	

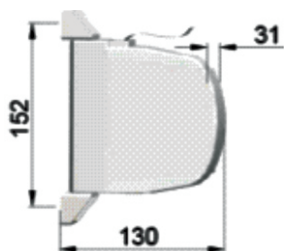

Avvolgitore a bandiera con/per cintino  
Mini-Gurtwickler Mit/fÜR Gurt  
Strap Coiler  
带式收绕盒

Articolo-Artikel	IL Colore-Farbe	Cintino-Gurt
Art.No.-编号	Colour-颜色	Strap-织带
	bianco-weiss-white-白色	

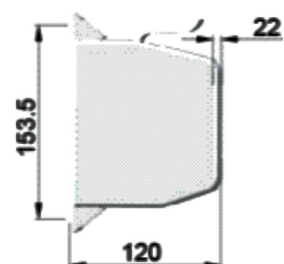

Avvolgitore a bandiera con/per cintino  
Mini-Gurtwickler Mit/fÜR Gurt  
Strap Coiler  
带式收绕盒

Articolo-Artikel	IL Colore-Farbe	Cintino-Gurt
Art.No.-编号	Colour-颜色	Strap-织带
	bianco-weiss-white-白色	

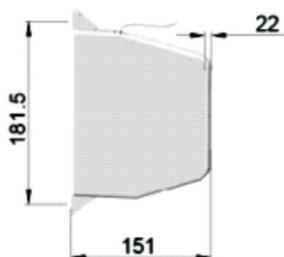

Avvolgitore a bandiera con/per cintino  
Mini-Gurtwickler Mit/fÜR Gurt  
Strap Coiler  
带式收绕盒

Articolo-Artikel	IL Colore-Farbe	Cintino-Gurt
Art.No.-编号	Colour-颜色	Strap-织带
	bianco-weiss-white-白色	

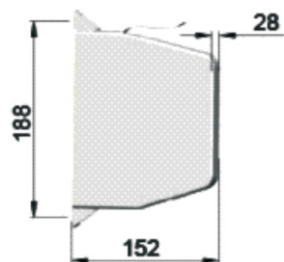

Avvolgitore a bandiera con/per cintino  
Mini-Gurtwickler Mit/fÜR Gurt  
Strap Coiler  
带式收绕盒

Articolo-Artikel	IL Colore-Farbe	Cintino-Gurt
Art.No.-编号	Colour-颜色	Strap-织带
	bianco-weiss-white-白色	

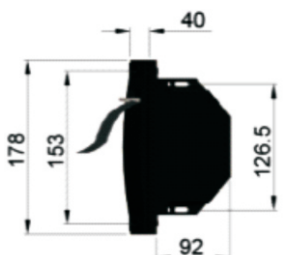

Avvolgitore a bandiera con/per cintino  
Mini-Gurtwickler Mit/fÜR Gurt  
Strap Coiler  
带式收绕盒

Articolo-Artikel	IL Colore-Farbe	Cintino-Gurt
Art.No.-编号	Colour-颜色	Strap-织带
	bianco-weiss-white-白色	

Avvolgitore "Zenith" per cintino 23\*2mm  
 Gurtwickler "Zenith" für Gurt 23\*2mm  
 Strap Coiler "Zenith" for strap 23\*2mm  
 意式ZN收绕器, 建议织带规格23\*2mm

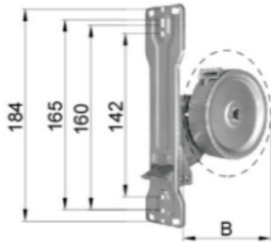

Articolo-Artikel	Capacity	Nota-Anm	B
Art.No.-编号		Remarks-备注	
	4m	con molla caricata	135mm
	6m	feder vorgespannt	160mm
	8m	Spring Wound Up	185mm
	11m	发条绕起	220mm
	12m		245mm
	4m	non caricata	135mm
	6m	feder nicht	160mm
	8m	Spring not Wound Up	185mm
	11m	发条不绕起	220mm
	12m		245mm

Placca ad incastro VENUS per Zenith |Plastica ABS  
 Steckabdeckplatte für Zenith |Kunststoff BAS  
 VENUS interlocking cover plate for Zenith |Plastic ABS  
 意式ZN收绕器用面板 |材质 ABS

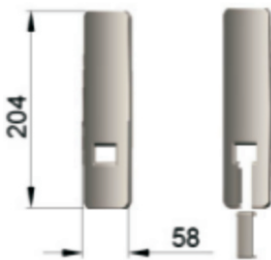

Articolo-Artikel	Colore-Farbe-Colour-颜色	Cintino-Gurt
Art.No.-编号	Bianco-weiss-white-白色	
	Nero-Schwarz-Black-黑色	
	Altri ciliri Disponibili-Andere	
	Farben zur auswahl other colors	
	availabe-也可定制颜色	

Placca per avvolgitore "Zenith"  
 Abdeckplatte für Gurtwickler "zenith"  
 Metallic Cover Plate for Strap coiler "Zenith"  
 意式ZN收绕器用面板



Articolo-Artikel	A	Materiale-Material	Colore-Farbe
Art.No.-编号		Materila-材质	Colour-颜色
	142mm	Inox Edelstahl Stainless Steel 不锈钢	Shining-Glanxende Shining-光面
	165mm		
	184mm		
	142mm	Alluminio Aluminum 铝	RAL9010.RAL9005. Altri colori Disponibili Andere Farben zur auswahl othercilkr availabe 也可定制颜色
	165mm		
	184mm		





Placca cieca per avvolgitore "zenith"  
Blindabdeckplatte Für Gurtwickler"Zenith"  
Blind Cover Plate for Strap coiler"Zenith"  
意式ZN收绕器用盲面板

Articolo-Artikel	A	Materiale-Material	Colore-Farbe
Art.No.-编号		Materila-材质	Colour-颜色
	142mm	Inox Edelstahl Stainless Steel 不锈钢	Shining-Glanxende Shining-光面
	165mm		
	184mm	Alluminio Aluminum 铝	RAL9010.RAL9005. Altri colori Disponibili Andere Farben zur auswahl othercilkr available 也可定制颜色
	165mm		

Avvolgitore"UNL"per cintino 23\*2mm  
Gurtwickler "UNL" Für Gurt 23\*2mm  
Strap Coiler "UNL" for strap 23\*2mm  
意式UNI收绕器，建议织带规格23\*2mm

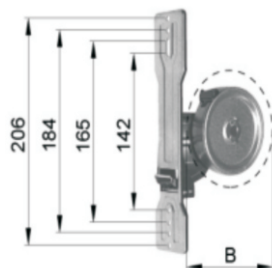

Articolo-Artikel	Capacity	Nota-Anm	B
		Remarks-备注	
	4m	con molla caricata	135mm
	6m	feder vorgespannt	160mm
	8m	Spring Wound Up	185mm
	10m	发条绕起	220mm
	12m		245mm
	4m	non caricata	135mm
	6m	feder nicht	160mm
	8m	Spring not Wound Up	185mm
	10m	发条不绕起	220mm
	12m		245mm
	11m	20*1.2mm	260mm





Placca per avvolgitore "UNI"  
 Abdeckplatte FÜR Gurtwickler "UNI"  
 Metallic Cover Plate for Strap coiler "UNI"  
 意式UNI收绕器，建议织带规格23\*2mm

Articolo-Artikel	Capacity	Materiale-Material	Colore-Farbe
Art.No.-编号		Materila-材质	Colour-颜色
	140mm	Inox Edelstahl Stainless Steel 不锈钢	Shining-Glanxende Shining-光面
	165mm		
	184mm		
	206mm		
	142mm	Alluminio Aluminum 铝	RAL9010.RAL9005. Altri colori Disponsbili Andere Farben zur auswahl othercilkr available 也可定制颜色
	165mm		
	184mm		
	206mm		



Placca cieca per avvolgitore "UNI"  
 Blindabdeckplatte FÜR Gurtwickler"UNI"  
 Blind Cover Plate for Strap coiler"UNI"  
 意式UNI收绕器用盲面板

Articolo-Artikel	A	Materiale-Material	Colore-Farbe
Art.No.-编号		Materila-材质	Colour-颜色
	184mm	Inox Edelstahl Stainless Steel 不锈钢	Shining-Glanxende Shining-光面
	206mm		
	184mm	Alluminio Aluminum 铝	RAL9010.RAL9005. Altri colori Disponsbili Andere Farben zur auswahl othercilkr available 也可定制颜色
	206mm		

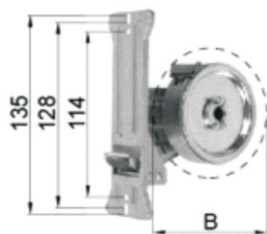

Avvolgitore"Starpiu"Per cintino 23\*1.8mm  
 Gurtwickler"Starpiu"FÜR Gurt 23\*1.8mm  
 Strap Coiler"Starpiu"for strap 23\*1.8mm  
 意式Starpiu收绕器，建议织带规格23\*1.8mm

Articolo-Artikel	Capacity	Cintino-Gut	B
Art.No.-编号		Stap-织带	
	4m	23*1.8mm	135mm
	5m	23*1.8mm	140mm
	6m	23*1.8mm	160mm
	7.5m	20*1.2mm	135mm
	11m	20*1.2mm	160mm



Placca per avvolgitore "Starpiu"  
Abdeckplatte Für Gurtwickler "Starpiu"  
Metallic Cover Plate for Strap coiler "Starpiu"  
意式Starpiu收绕器用面板

Articolo-Artikel	A	Materiale-Material	Colore-Farbe
Art.No.-编号		Materila-材质	Colour-颜色
	114mm	Inox Edelstahl Stainless Steel 不锈钢	Shining-Glanxende Shining-光面
	128mm		
	135mm		
	114mm	Alluminio Aluminum 铝	RAL9010.RAL9005. Altri colori Disponsbili Andere Farben zur auswahl othercilkr availabe 也可定制颜色
	128mm		
	135mm		

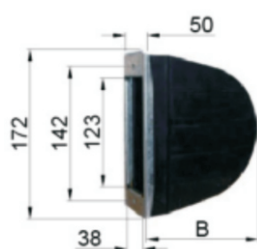

Cassetta in Plastica  
Kunststoff Mauerkaste  
Plastic Box for Strap Coiler  
收绕器用防护盒

Articolo-Artikel	Capacity	B
Art.No.-编号		
	4m	140mm

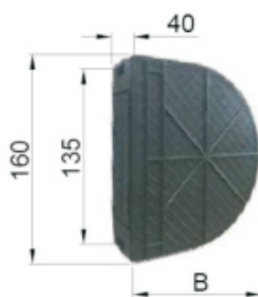

Cassetta in Plastica  
Kunststoff Mauerkaste  
Plastic Box for Strap Coiler  
收绕器用防护盒

Articolo-Artikel	Capacity	B
Art.No.-编号		
	5m	140mm

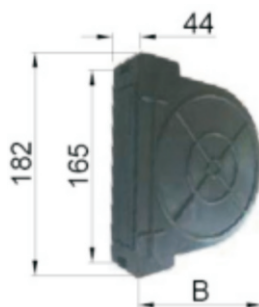

Cassetta in Plastica  
Kunststoff Mauerkaste  
Plastic Box for Strap Coiler  
收绕器用防护盒

Articolo-Artikel	Capacity	B
Art.No.-编号		
	6m	170mm



Cassetta in Plastica  
Kunststoff Mauerkaste  
Plastic Box for Strap Coiler  
收绕器用防护盒

Articolo-Artikel	Capacity	B
Art.No.-编号		
	12m	240mm

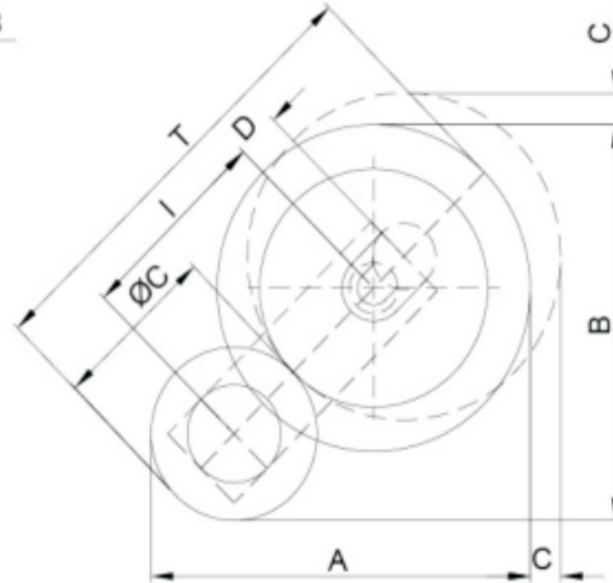
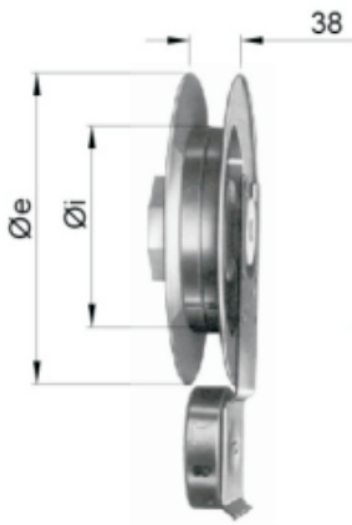

(Cintino-strap / 20×1.2mm)

Avvolgitori A Cassonetto OMEGA  
Kastenwickler OMEGA  
Shutter Housing Coilers OMEGA  
收绕轮盘组合

KIT Number	Pulley	OD of Pulley $\phi_e$ mm	Bottom Diameter of pulley $\phi_i$ mm	I mm	Strap Width C mm	Strap Lenth L mm	Turns	Load Capacity kg	A mm	B mm	C mm	D mm	T mm
	408.202.614	135	90	102	95	2.0	6.5	9	190	190	20	28	215
	408.202.616	160	110	114	106	2.5	6.5	12	216	216	20	28	250
	408.202.618	180	125	124	110	2.8	6.5	15	235	235	20	28	270
	408.202.620	200	142	134	112	3.2	6.5	20	252	252	20	28	290



Avvolgitore Eku-Omega per sostituzioni  
ku-Omega Gurtwickler  
Eku-Omega strap coiler for replacements  
Eku-Omega 款收绕盒

Articolo-Artikel	Capacity	Nota-Anm-Remarks-备注
Art.No.-编号	6m	galv.Steel

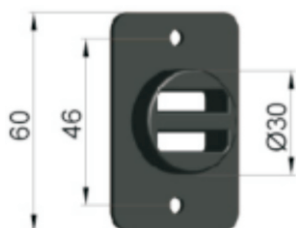

Guidacinghia vert.in pladtica per Omega  
Senkrechte Gurtführung aus Kunststoff FÜR OMEGA  
Vertical plastic strap guide for Omega  
OMEGA 用双扁导口 (立式)

Articolo-Artikel	Colore-Farbe-Colour-颜色
Art.No.-编号	Bianco-Weiss-White-白色 Nero-schwarz-black-黑色 Altri colari Disponibili-Andere Farben zur auswahl other colars availabe-也可定制颜色



Guidacinghia trasversale in pladtica per Omega  
Waagerechte Gurtführung aus Kunststoff FÜR OMEGA  
Horizontal plastic strap guide for Omega  
OMEGA 用双扁导口 (横式)

Articolo-Artikel	Colore-Farbe-Colour-颜色
Art.No.-编号	Bianco-Weiss-White-白色 Nero-schwarz-black-黑色 Altri colari Disponibili-Andere Farben zur auswahl other colars availabe-也可定制颜色

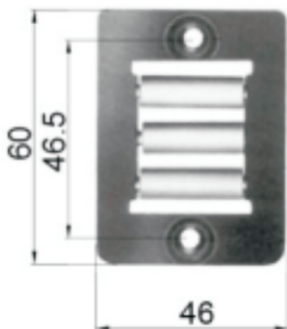

Guidacinghia tre rulli per Omega  
Gurfführung mit drei Rollen FÜR OMEGA  
Strap guide with three rollers for Omega  
OMEGA 用导轮

Articolo-Artikel	Finiture-Finishes-备注
Art.No.-编号	zincato-galv-镀锌

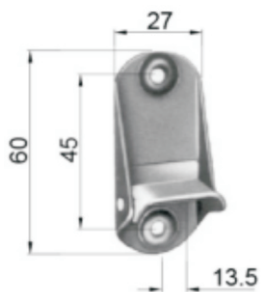

Bloccacintino per avvolglitori Omega  
Gurtklemmer FÜR Wickler OMEGA  
Strap lock for coilers OMEGA  
OMEGA 用带扣

Articolo-Artikel	Finiture-Finishes-备注
Art.No.-编号	zincato-galv-镀锌

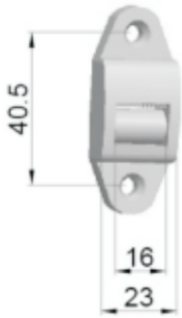

Guidacinghia verticale per cintino 14mm  
Leitrolle, senkrecht, Für Gurt 14mm  
Strap Guide, vertical, for Strap 14mm  
织带导轮, 14mm宽织带用

Articolo-Artikel	Colore-Farbe-Colour-颜色
Art.No.-编号	
Bianco-Weiss-White-白色 Altri colori Disponibili-Andere Farben zur auswahl other colars availabe-也可定制颜色	

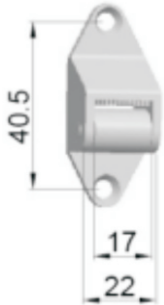

Guidacinghia verticale per cintino 14mm  
Leitrolle, senkrecht, Für Gurt 14mm  
Strap Guide, vertical, for Strap 14mm  
织带导轮, 14mm宽织带用

Articolo-Artikel	Colore-Farbe-Colour-颜色
Art.No.-编号	
Bianco-Weiss-White-白色 Altri colori Disponibili-Andere Farben zur auswahl other colars availabe-也可定制颜色	

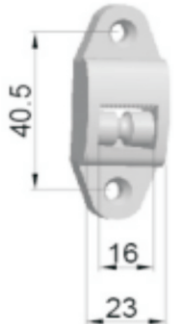

Guidacinghia verticale per cordone Ø4mm  
Schnurführung, senkrecht, Für schnur Ø4mm  
Rope Guide, vertical, for Rope Ø4mm  
绳导轮, Ø4mm绳子用

Articolo-Artikel	Colore-Farbe-Colour-颜色
Art.No.-编号	
Bianco-Weiss-White-白色 Altri colori Disponibili-Andere Farben zur auswahl other colars availabe-也可定制颜色	

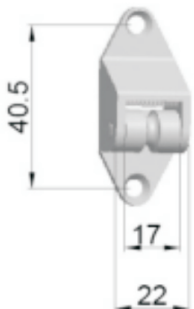

Guidacinghia verticale per cordone Ø4mm  
Schnurführung, senkrecht, Für schnur Ø4mm  
Rope Guide, vertical, for Rope Ø4mm  
绳导轮, Ø4mm绳子用

Articolo-Artikel	Colore-Farbe-Colour-颜色
Art.No.-编号	
Bianco-Weiss-White-白色 Altri colori Disponibili-Andere Farben zur auswahl other colars availabe-也可定制颜色	



Guidacinghia zinc.per cintino 14mm  
Leitrolle, verzinkt, Für gurt 14mm  
Strap Guide, galvanized, for strap 14mm  
铁支架织带导轮, 14mm宽织带用

Articolo-Artikel	Colore-Farbe-Colour-颜色
Art.No.-编号	
Bianco-Weiss-White-白色 Altri colori Disponibili-Andere Farben zur auswahl other colars availabe-也可定制颜色	

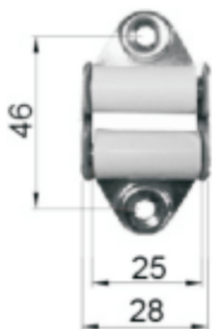

Guidacinghia zinc.per cinghino 23mm  
Leitrolle,verzinkt,FÜR gurt 23mm  
Strap Guide,galvanized,for strap 23mm  
铁支架织带导轮, 23mm 宽织带用

Articolo-Artikel	Colore-Farbe-Colour-颜色
Art.No.-编号	
Bianco-Weiss-White-白色 Altri colori Disponibili-Andere Farben zur auswahl other colors available-也可定制颜色	



Guidacinghia verticale per cinghino 23mm  
Leitrolle,senkrecht,FÜR gurt 23mm  
Strap Guide,vertical,for strap 23mm  
立式织带导轮, 23mm 宽织带用

Articolo-Artikel	Colore-Farbe-Colour-颜色
Art.No.-编号	
Bianco-Weiss-White-白色 Altri colori Disponibili-Andere Farben zur auswahl other colors available-也可定制颜色	



Guidacinghia Transversale per cinghino 23mm  
Waagerechte Leitrolle,FÜR gurt 23mm  
Strap Guide,horizontal,for strap 23mm  
织带导轮, 23mm 宽织带用

Articolo-Artikel	Colore-Farbe-Colour-颜色
Art.No.-编号	
Bianco-Weiss-White-白色 Altri colori Disponibili-Andere Farben zur auswahl other colors available-也可定制颜色	

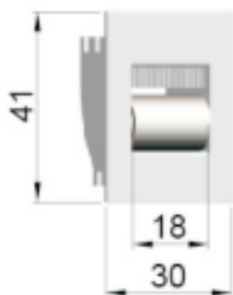

Guidacinghia per fianchi in alluminio per cinghino 18mm  
Gurfführung für alu blendkappen,FÜR gurt 18mm  
Strap Guide,for aluminum end caps,for strap 18mm  
端盖配用的织带导轮, 18mm 宽织带用

Articolo-Artikel	Colore-Farbe-Colour-颜色
Art.No.-编号	
Bianco-Weiss-White-白色 Altri colori Disponibili-Andere Farben zur auswahl other colors available-也可定制颜色	

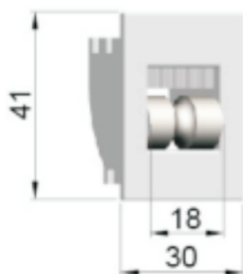

Guidacinghia per fianchi in alluminio per cinghino 04mm  
Gurfführung für alu blendkappen,FÜR gurt 04mm  
Strap Guide,for aluminum end caps,for strap 04mm  
端盖配用的织带导轮, 04mm 宽织带用

Articolo-Artikel	Colore-Farbe-Colour-颜色
Art.No.-编号	
Bianco-Weiss-White-白色 Altri colori Disponibili-Andere Farben zur auswahl other colors available-也可定制颜色	

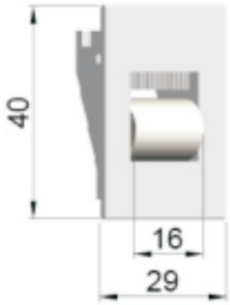

Guidacinghia per fianchi in alluminio per cinghio 14mm  
Gurfführung für alu blendkappen, für gurt 14mm  
Strap Guide, for aluminum end caps, for strap 14mm  
端盖配用的织带导轮, 14mm 宽织带用

Articolo-Artikel	Colore-Farbe-Colour-颜色
Art.No.-编号	
	Bianco-Weiss-White-白色 Altri colori Disponibili-Andere Farben zur Auswahl other colors available-也可定制颜色

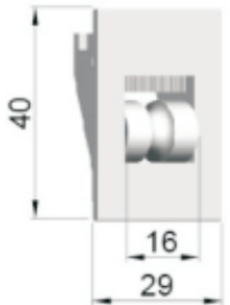

Guidacinghia per fianchi in alluminio per cinghio 04mm  
Gurfführung für alu blendkappen, für gurt 04mm  
Strap Guide, for aluminum end caps, for strap 04mm  
端盖配用的织带导轮, 04mm 宽织带用

Articolo-Artikel	Colore-Farbe-Colour-颜色
Art.No.-编号	
	Bianco-Weiss-White-白色 Altri colori Disponibili-Andere Farben zur Auswahl other colors available-也可定制颜色

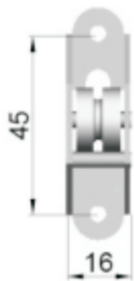

Guida per fune metallica  
Guide für drahtseil  
Steel Rope Guide  
钢丝绳导轮

Articolo-Artikel	Finiture-Finishes-备注
Art.No.-编号	
	zincato-galv-镀锌

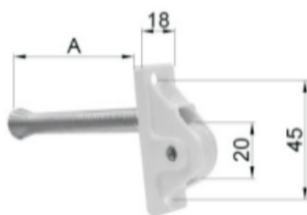

Guidacordone con molla  
Schnurführung, mit Spiralfeder  
Rope Guide with spring  
绳导轮

Articolo-Artikel	A	Colore-Farbe-Colour-颜色
Art.No.-编号		
		Bianco-Weiss-White-白色
	100mm	Altri colori Disponibili-Andere Farben zur Auswahl, other colors available-也可定制颜色
	250mm	定制颜色



Rullino di rinvio piccolo (33mm) registrabile  
Kunststoff abdruckrille (33mm), verstellbar  
Guide Roller (33mm), adjustable  
位置可调导轮

Articolo-Artikel	Colore-Farbe-Colour-颜色
Art.No.-编号	
	Bianco-Weiss-White-白色 Altri colori Disponibili-Andere Farben zur Auswahl other colors available-也可定制颜色





Rullino di rinvio piccolo (33mm)  
Kunststoff abdruckrille(33mm)  
Guide Roller (33mm)  
导轮

Articolo-Artikel	Colore-Farbe-Colour-颜色
Art.No.-编号	
Bianco-Weiss-White-白色 Altri colori Disponibili-Andere Farben zur auswahl, other colars availabe-也可定制颜色	



Guidacinghia vert.in plastica per Omega  
Waagerechte Gurfführung aus Kunststoff  
Horizontal plastic strap guide  
横式织带单扁导口

Articolo-Artikel	Colore-Farbe-Colour-颜色
Art.No.-编号	
Bianco-Weiss-White-白色 Altri colori Disponibili-Andere Farben zur auswahl, other colars availabe-也可定制颜色	

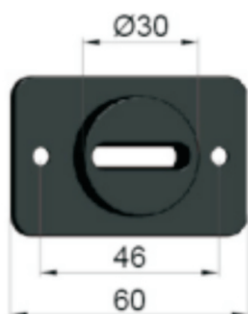

Guidacinghia trasversale.in plastica  
Senkrechte Gurfführung aus Kunststoff  
Vertical plastic strap guide  
立式织带单扁导口

Articolo-Artikel	Colore-Farbe-Colour-颜色
Art.No.-编号	
Bianco-Weiss-White-白色 Altri colori Disponibili-Andere Farben zur auswahl, other colars availabe-也可定制颜色	



Tappo per foro guidacinghia  
Kunststoff Verschluss  
Stopper for strap guide hole  
织带孔堵头

Articolo-Artikel	Colore-Farbe-Colour-颜色
Art.No.-编号	
Bianco-Weiss-White-白色 Altri colori Disponibili-Andere Farben zur auswahl, other colars availabe-也可定制颜色	



Codici per Supportive "TORINO", Normali Completi  
Kit of Support "TORINO", z-shaped Vertical Arms  
Z型支架成套

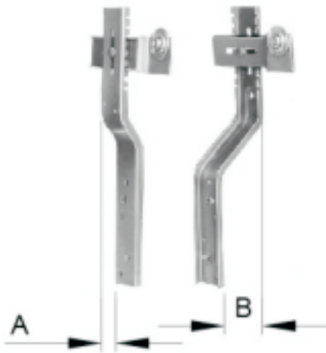

Codici Kit NO.	Parte Verticale Vertical Arm A = mm	Parte Verticale Vertical Arm A = mm	Vite Bolt and Nut M6x20 set	Mensola Bearing brackett		Cuscinetti innesto Bearing 30 mm nr.
				Right mm	Left mm	
402.V1.100	402.V1.100	402.V1.100	M6x20	402.H1.11R	402.H1.11L	405.301.09
1	1	1	2	1	1	2
402.V1.025	402.V1.100	402.V1.100	M6x20	402.H1.11R	402.H1.11L	405.301.09
1	1	1	2	1	1	2
402.V1.025	402.V1.025	402.V1.025	M6x20	402.H1.11R	402.H1.11L	405.301.09
1	1	1	2	1	1	2
402.V1.025	402.V1.080	402.V1.080	M6x20	402.H1.11R	402.H1.11L	405.301.09
1	1	1	2	1	1	2
402.V1.070	402.V1.070	402.V1.070	M6x20	402.H1.07R	402.H1.07L	405.301.09
1	1	1	2	1	1	2
402.V1.080	402.V1.080	402.V1.080	M6x20	402.H1.11R	402.H1.11L	405.301.09
1	1	1	2	1	1	2

Codici per Supportive "TORINO", Roversciati Completi  
Kit of Support "TORINO", z-shaped Vertical Arms (Reverse)  
Z型反向支架成套

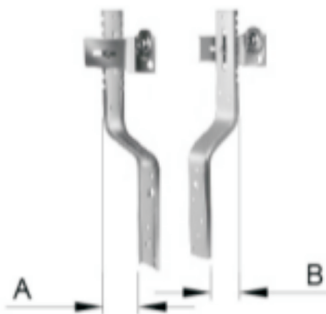

Codici Kit NO.	Parte Verticale Vertical Arm	Parte Verticale Vertical Arm	Vite Bolt and Nut M6x20 set	Mensola Bearing brackett		Cuscinetti innesto Bearing 30 mm nr.
				Right mm	Left mm	
	A = 65 mm	B = 65 mm	2	p=11 mm	p=11 mm	2
402.V1.R065	402.V1.R065	402.V1.R065	M6x20	402.H1R.11R	402.H1R.11R	405.301.09
	A = 85 mm	B = 85 mm	2	p=11 mm	p=11 mm	2
402.V1.R085	402.V1.R085	402.V1.R085	M6x20	402.H1R.11R	402.H1R.11R	405.301.09

Codici Per Supporto "TORINO" A Squadro Completo  
Kit of Support "TORINO" 90° Bended Arms  
直角支架成套



Codici Kit NO.	Parte verticale asquadra Vertical arm, 90° A = mm	Vite Bolt and Nut M6x20 set	Mensola Bearing brackett		Cuscinetti innesto Bearing 30 mm nr.
			Right mm	Left mm	
402.V1S.50	50	M6x20	402.H1.11R	402.H1.11L	405.301.09
2	2	2	1	1	2



Parte verticale per support"TORINO"  
Vertical Arm for Torino Supports,Z shaped  
Z型端支架

Articolo-Art.No.-编号	Size
	P=25mm
	P=70mm
	P=80mm
	P=100mm
	P=120mm



Parte verticale per support"TORINO"  
Vertical Arm for Torino Supports,Straight  
Z型端支架

Articolo-Art.No.-编号	Size
	P=0mm



Parte verticale per support"TORINO"  
Vertical Arm for Torino Supports,Z shaped(reverse)  
Z型反向端支架

Articolo-Art.No.-编号	Size
	P=65mm
	P=85mm

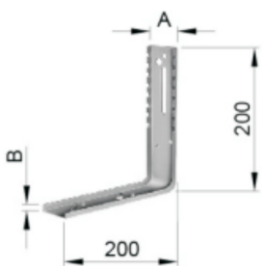

Parte verticale per support"TORINO"90°  
Vertical Arm for Torino Supports,90°  
bended直角端端支架

Articolo-Art.No.-编号	Size
	A=40mm,B=10mm,90° bended
	A=46mm,B=10mm,90° bended
	A=50mm,B=10mm,90° bended

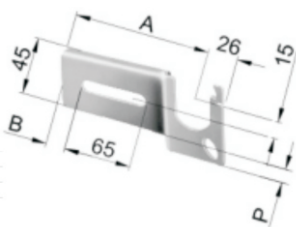

Mensole per supporti TORINO DESTRA  
Bracket for Torino supports right  
冲压轴承支架, 右

Articolo-Art.No.-编号	A	B	Others
	146	25	P=11mm
	146	25	P=7mm

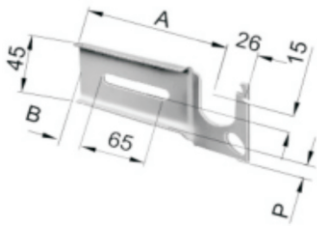

**Mensole Rovesciate per supporti TORINO DESTRA**  
Bracket for Torino supports right(reverse)  
冲压轴承支架，右

Articolo-Art.No.-编号	A	B	Others
	146	25	P=11mm

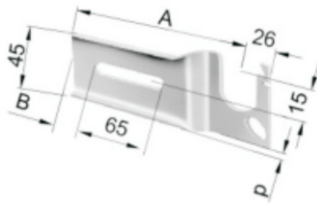

**Mensole per supporti TORINO SINISTRE**  
Bracket for Torino supports right(reverse)  
冲压轴承支架，左

Articolo-Art.No.-编号	A	B	Others
	146	25	P=11mm
	146	25	P=7mm

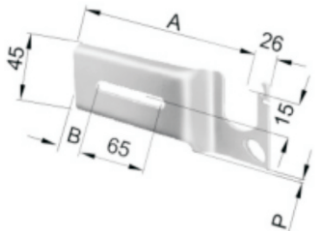

**Mensole Rovesciate per supporti TORINO SINISTRE**  
Bracket for Torino supports left  
冲压轴承支架（反向），左

Articolo-Art.No.-编号	A	B	Others
	146	25	P=11mm

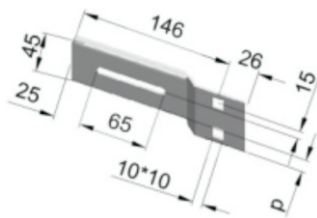

**Mensola per supporti TORINO con fori ■10**  
Bracket for Torino support with two holes ■10  
10mm 双方孔支架

Articolo-Art.No.-编号	L/R	P
	Left	11mm
	Right	11mm

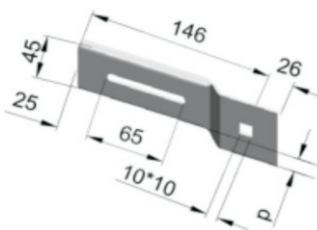

**Mensola per supporti TORINO con fori ■10**  
Bracket for Torino support with two holes ■10  
10mm 双方孔支架

Articolo-Art.No.-编号	L//R	P
	Left	11mm
	Right	11mm

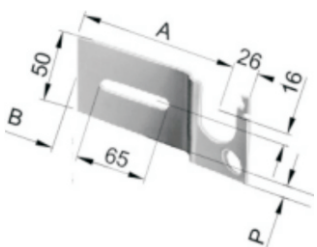

**Mensole per supporti Mantova DX**  
Bracket for Mantova supports, right  
冲压轴承支架，右

Articolo-Art.No.-编号	A	B	Others
	146	25	P=11mm
	125	4	P=11mm
	146	25	P=7mm

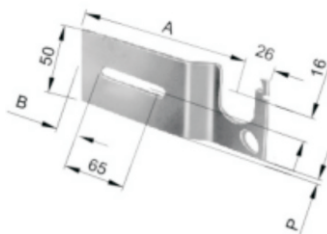

Mensole per supporti Mantova DX  
Bracket for Mantova supports, right  
冲压轴承支架, 右

Articolo-Art.No.-编号	A	B	Others
	146	25	P=11mm
	125	4	P=11mm
	146	25	P=7mm

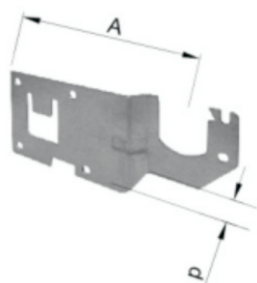

Mensole per controtelai "M.U".Destra  
"M.U."bracket for frames, Right  
冲压轴承支座, 右

Articolo-Art.No.-编号	L/R	A	Others
	Right	135	P=9mm

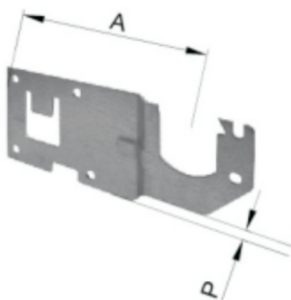

Mensole per controtelai "M.U".Destra  
"M.U."bracket for frames, Left  
冲压轴承支座, 左

Articolo-Art.No.-编号	L/R	A	Others
	Right	135	P=9mm

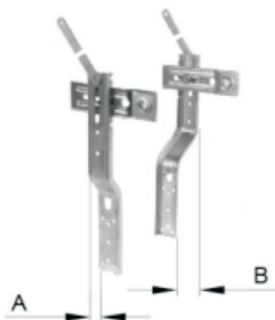

Kit:Supporti"NAPOU"con mensole  
Kit:"NAPOU"supports with brackets  
"NAPOLI"支架成套

Articolo-Art.No.-编号	A	B
	30mm	80mm
	30mm	30mm
	80mm	80mm

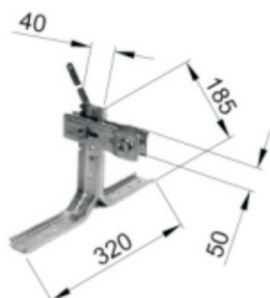

Kit:Supporti"NAPOU"con mensole  
Kit:"NAPOU"supports with brackets  
"NAPOLI"支架成套

Articolo-Art.No.-编号	Nota-Remarks-备注
	Zinc-galv-镀锌

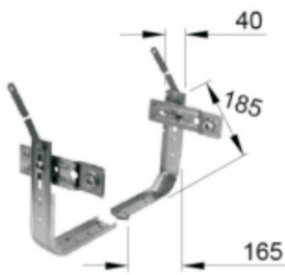

Kit:Supporti"NAPOLI"con mensole  
Kit:"NAPOLI"supports with brackets  
"NAPOLI"支架成套

Articolo-Art.No.-编号	Nota-Remarks-备注
	Zinc-galv-镀锌



Mensola per supporti"NAPOLI"e squadro con cuscinetto  
Bracket for "NAPOLI"supports with bearing  
"NAPOLI"横支架

Articolo-Art.No.-编号	Nota-Remarks-备注
	Zinc-galv-镀锌

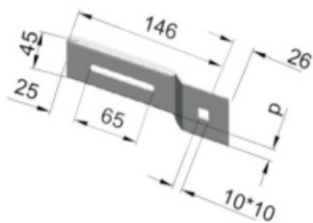

Mensola per supporti NAPOLI con foro ■ 10  
Bracket for NAPOLI supports with hole ■ 10  
NAPOLI 10mm单方孔支架

Articolo-Art.No.-编号	L/R	P
	Left	11mm
	Right	11mm

Rullo In Ferro E Accessori  
Achtkantwellen Und ZubehÖre  
Octagonal Tube 八角管



Articolo-Art.No.-编号	Diametro-Durchmesser Diameter-直径mm	Spessore-Starke Thickness-壁厚mm
	Oct-40	0.4
	Oct-40	0.6
	Oct-40	0.8
	Oct-60	0.6
	Oct-60	0.8
	Oct-60	1.0
	Oct-70	1.1
	Oct-70	1.2

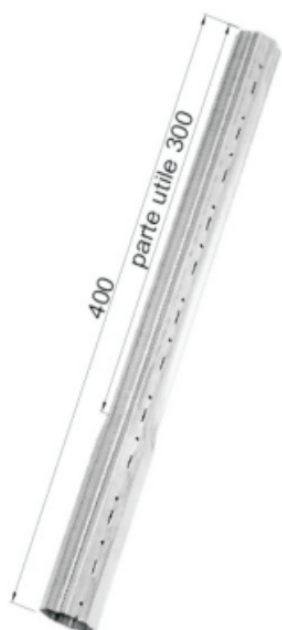

Prolunga(corsa 250mm)zincata  
Teleskopwelle(lauf 250mm)  
Tube Extension(stroke 250mm)  
异形八角管 (可调节行程 250mm)

Articolo-Art.No.-编号	Nota-Anm-Remarks-备注
	Per rullo oct60*0.6 Für oct60*0.6 For oct60*0.6 与oct60*0.6配合使用
	Per rullo oct60*0.8 Für oct60*0.8 For oct60*0.8 与oct60*0.8配合使用
	Per rullo oct60*1.0 Für oct60*1.0 For oct60*1.0 与oct60*1.0配合使用
	Per rullo oct70*1.1 Für oct70*1.1 For oct70*1.1 与oct70*1.1配合使用



Rullo In Ferro E Accessori  
Achtkantwellen Und ZubehÖre  
Octagonal Tube 八角管

Articolo-Art.No.-编号	A(mm)	Nota-Anm-Remarks-备注
	350	Per rullo oct60*0.6 Für oct60*0.6
	500	For oct60*0.6 与oct60*0.6配合使用
	350	Per rullo oct60*0.8 Für oct60*0.8
	500	For oct60*0.8 与oct60*0.8配合使用
	350	Per rullo oct60*1.0 Für oct60*1.0
	500	For oct60*1.0 与oct60*1.0配合使用
	500	Per rullo oct70*1.1 Für oct70*1.1 For oct70*1.1 与oct70*1.1配合使用

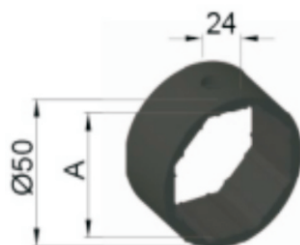

Rullo In Ferro E Accessori  
Achtkantwellen Und ZubehÖre  
Octagonal Tube 八角管

Articolo-Art.No.-编号	A(mm)
	Oct40

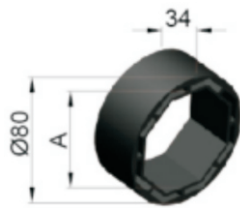

Adattatore per rullo offogonale oct 60  
Aufsteckringe für achkantwellen oct 60  
Adapter ring for fubes oct 60  
60八角管轴套

Articolo-Art.No.-编号	A(mm)
	Oct60

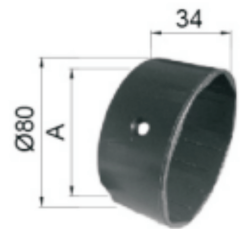

Adattatore per rullo offogonale oct 70  
Aufsteckringe für achkantwellen oct 70  
Adapter ring for fubes oct 70  
70八角管轴套

Articolo-Art.No.-编号	A(mm)
	Oct70

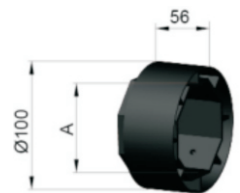

Adattatore per rullo offogonale oct 70  
Aufsteckringe für achkantwellen oct 70  
Adapter ring for fubes oct 70  
70八角管轴套

Articolo-Art.No.-编号	A(mm)
	Oct70

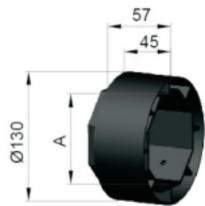

Adattatore per rullo offogonale oct 70"XL"  
Aufsteckringe für achkantwellen oct 70"XL"  
"XL"Adapter ring for fubes oct 70  
70八角管轴套

Articolo-Art.No.-编号	A(mm)
	Oct70



Gancio per attacco cinfo al rullo  
Einhängeösen für Gurtbefestigung  
Slotted clips for strap fastening  
带扣

Articolo-Art.No.-编号	Nota-Anm-Remarks-备注
	galv.Steel



Profilo di alluminio(Stecca)  
Aluminium-profil(stäbe)  
Extruded Aluminum slat  
41挤压帘片

Articolo-Art.No.-编号	Nota-Anm-Remarks-备注
	Aluminum Extruded Slat



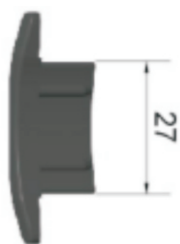

Calotta per stecca 403.EST.41  
Kapsel für stäbe 403.EST.41  
Plastic cap for extruded slat 403.EST.41  
41帘片侧扣

Articolo-Art.No.-编号	Nota-Anm-Remarks-备注
	PP

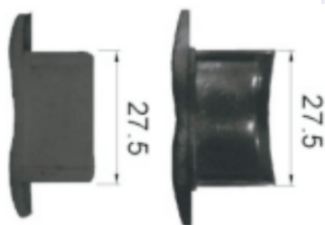

Calotta per stecca 37mm  
Kapsel für stäbe 37mm  
End cap for slat 37mm  
37mm帘片用侧扣

Articolo-Art.No.-编号	IL Colore-Farbe-Colour-颜色
	Nero-schwarz-black-黑色
	Nero-schwarz-black-黑色

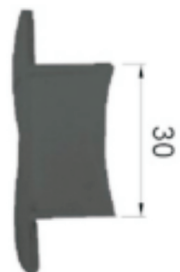

Calotta per stecca 37mm  
Kapsel für stäbe 37mm  
End cap for slat 37mm  
37mm帘片用侧扣

Articolo-Art.No.-编号	IL Colore-Farbe-Colour-颜色
	Nero-schwarz-black-黑色

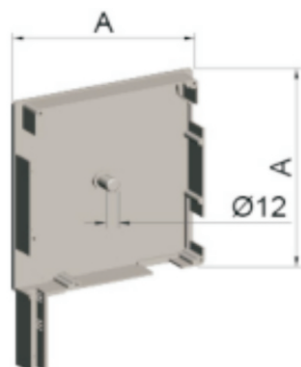

Paia di fianchi(DX e SN)90°  
Paar blendkappen(rechts und links)90°  
Pair of Universal End Cap(Left & Right)90°  
通用型90° 铝端盖

Articolo-Art.No.-编号	A(mm)	Finiture-Oberflache Finishes-表面
	137	mill finish
	137	painting
	165	mill finish
	165	painting
	180	mill finish
	180	painting
	205	mill finish
	205	painting

Universal Leg size 16\*24mm and to be assembled with aluminum sheet boxes.  
通用的尺寸16\*24mm, 同铝板罩壳配套使用。

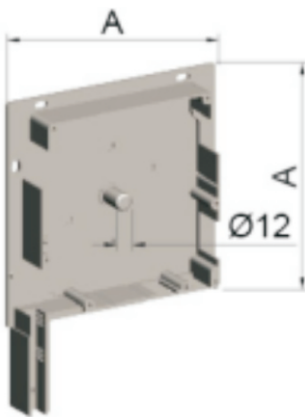

Paia di fianchi(DX e SN)90° , per Cassometto PVC  
 Paar blendkappen(rechts und links)90° ,für Kasten PVC  
 Pair of End Cap(Left & Right)90° ,for PVC box  
 90° 铝端盖(PVC罩壳用)

Articolo-Art.No.-编号	A(mm)	Finiture-Oberflache Finishes-表面
	155	mill finish
	155	painted
	185	mill finish
	285	painted
	200	mill finish
	200	painted

Universal Leg size 16\*24mm and to be assembled with aluminum sheet boxes.  
 通用的尺寸16\*24mm, 同铝板罩壳配套使用。

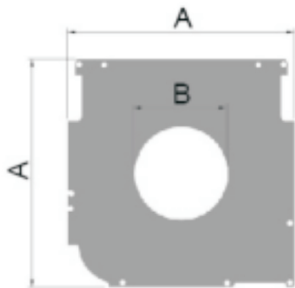

Flangia di contenimento zinc 90° ,per fianchi 404.90...2  
 Abweisblech verz,90° für blendkappen 404.90...2  
 Security Plate 90° for End Caps 404.90...2 series  
 安全盖板90° , 配用404.90...2 系列

Articolo-Art.No.-编号	Fianchi Blendkappen End cap-端盖尺寸 mm	B(mm)
	155	55
	185	55
	185	72
	200	72

Paia di fianchi(DX e SN)45°  
 Paar blendkappen(rechts und links)45°  
 Pair of End Universal End Cap (Left & Right)45°  
 通用型45° 铝端盖

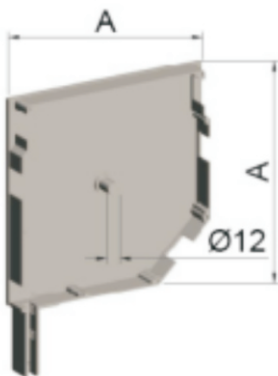

Articolo-Art.No.-编号	A(mm)	Finiture-Oberflache Finishes-表面
	105	mill finish
	105	painted
	137	mill finish
	137	painted
	150	mill finish
	150	painted
	165	mill finish
	165	painted
	180	mill finish
	180	painted
	205	mill finish
	205	painted

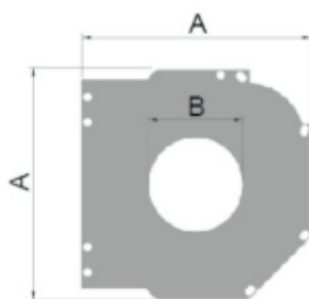

To be assembled with  
Universal End Caps 45°  
安装于通用型45°铝端盖上

Flangia di contenimento zinc 45°, per fianchi 404.45...1  
Abweisblech verz,90° für blendkappen 404.90...1  
Security Plate 90° for End Caps 404.90...1 series  
安全盖板90°，配用404.90...1 系列

Articolo-Art.No.-编号	Fianchi Blendkappen End cap-端盖尺寸 mm	B(mm)
	137	55
	150	55
	165	55
	165	72
	180	55
	180	72
	205	55
	205	72

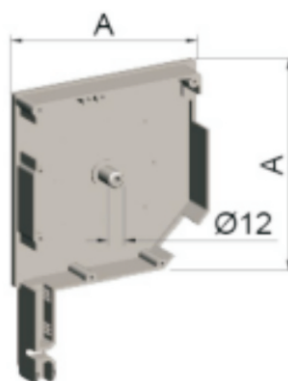

Besides as Universal End caps, they can also be used for combination of insect screen and roller shutters. Leg size 16\*24mm  
该款铝端盖可内置纱窗，也可作为通用弄使作，尺寸16\*24mm/。

Paia di fianchi(DX e SN)45°  
Paar blendkappen(rechts und links)45°  
Pair of End Cap (Leff & Right)45°  
45° 多功能铝端盖 (可内置纱窗)

Articolo-Art.No.-编号	A(mm)	Finiture-Oberflache Finishes-表面
	137	mill finish
	137	painted
	150	mill finish
	150	painted
	165	mill finish
	165	painted
	180	mill finish
	180	painted
	205	mill finish
	205	painted

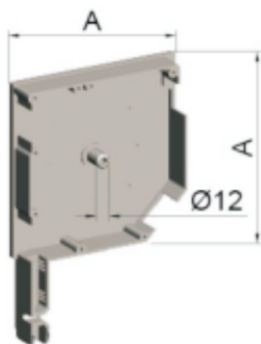

Paia di fianchi(DX e SN)45°  
Paar blendkappen(rechts und links)45°  
Pair of End Cap (Leff & Right)45°  
45° 多功能铝端盖 (可内置纱窗)

Articolo-Art.No.-编号	A(mm)	Finiture-Oberflache Finishes-表面
	230	mill finish
	230	painted

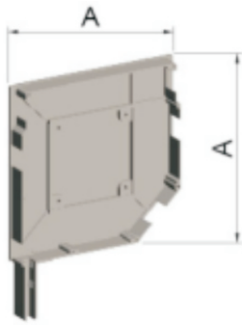

Paia di fianchi(DX e SN)45°Per motore  
Paar blendkappen(rechts und links)45° ,für der motor  
Pair of End Cap (Left & Right)45° for fubular motor  
45° 管状电机用铝端盖

Articolo-Art.No.-编号	A(mm)	Finiture-Oberflache Finishes-表面
	180	mill finish
	180	painted
	205	mill finish
	205	painted

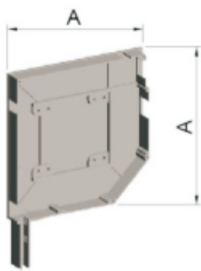

Paia di fianchi(DX e SN)45°Per motore  
Paar blendkappen(rechts und links)45° ,für der motor  
Pair of End Cap 45° for fubular motor  
45° 管状电机用铝端盖

Articolo-Art.No.-编号	A(mm)	Finiture-Oberflache Finishes-表面
	250	mill finish
	250	painted

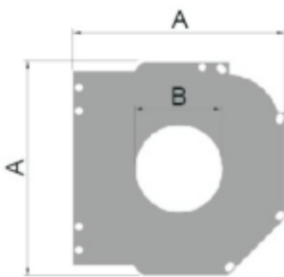

Flangia di contenimento zinc 45°,per fianchi 404.45...3  
Abweisblech verz,45° für blendkappen 404.45...3  
Security Plate 45° for End Caps 404.45...3 series  
安全盖板45° , 配用404.45...3 系列

Articolo-Art.No.-编号	Fianchi Blendkappen End cap-端盖尺寸 mm	B(mm)
	180	55
	180	72
	205	55
	205	72
	250	72
	250	82
	250	92

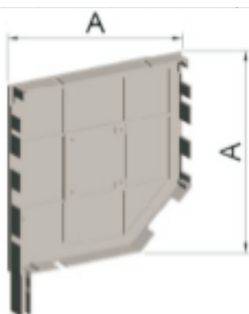

Paia di fianchi(DX e SN)45° Per motore  
Paar blendkappen(rechts und links)45° ,für der motor  
Pair of End Cap 45° for fubular motor  
45° 管状电机用铝端盖

Articolo-Art.No.-编号	A(mm)	Finiture-Oberflache Finishes-表面
	300	mill finish
	300	painted

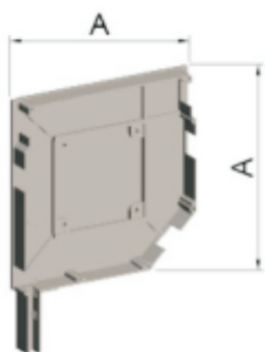

Paia di fianchi 45° Per motore  
Paar blendkappen 45° ,für der motor  
Pair of End Cap 45° for fubular motor,large leg  
45° 管状电机用铝端盖,大尺寸腿

Articolo-Art.No.-编号	A(mm)	Nota-Anm-Remarks-备注
	205	mill finish.large leg-大腿
	205	painted, large leg-大腿

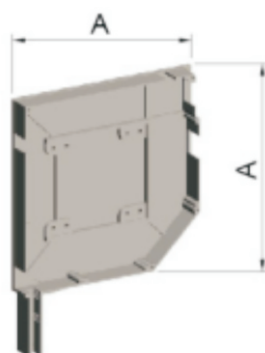

Paia di fianchi 45° Per motore  
Paar blendkappen 45° ,für der motor  
Pair of End Cap 45° for fubular motor,large leg  
45° 管状电机用铝端盖,大尺寸腿

Articolo-Art.No.-编号	A(mm)	Nota-Anm-Remarks-备注
	250	mill finish.large leg-大腿
	250	painted, large leg-大腿

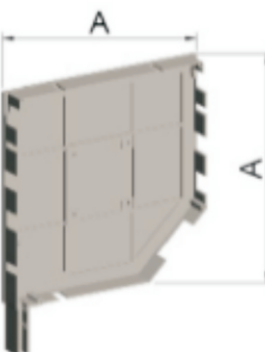

Paia di fianchi 45° Per motore  
Paar blendkappen 45° ,für der motor  
Pair of End Cap 45° for fubular motor,large leg  
45° 管状电机用铝端盖,大尺寸腿

Articolo-Art.No.-编号	A(mm)	Nota-Anm-Remarks-备注
	300	mill finish.large leg-大腿
	300	painted, large leg-大腿

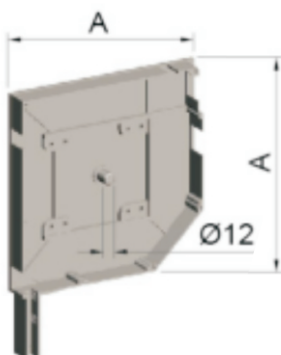

Paia di fianchi(DX e SN)45° Per motore, con pemo Ø12  
Paar blendkappen(rechts und links)45° für der motor,mit stiff Ø12  
Pair of End Cap 45° for fubular motor,with pivot Ø12  
45° 管状电机用铝端盖,带Ø12的柱子

Articolo-Art.No.-编号	A(mm)	Finiture-Oberflache Finishes-表面
	250	mill finish
	250	painted

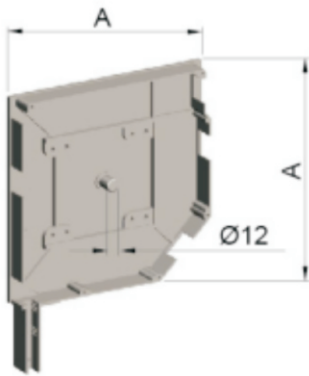

Paia di fianchi(DX e SN)45°Per motore, con pemo Ø12  
 Paar blendkappen(rechts und links)45° für der motor, mit stiff Ø12  
 Pair of End Cap 45° for fubular motor, with pivot Ø12  
 45° 管状电机用铝端盖,带Ø12的柱子

Articolo-Art.No.-编号	A(mm)	Finiture-Oberflache Finishes-表面
	300	mill finish
	300	painted

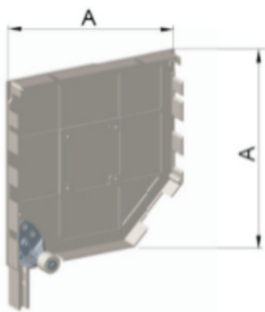

Paia di fianchi(DX e SN)45°Per motore, con Rullino  
 Paar blendkappen(rechts und links)45° für der motor, mit Paar Einlaufrollen  
 Pair of End Cap 45° for fubular motor, with guide rollers  
 45° 管状电机用铝端盖,带引导轮

Articolo-Art.No.-编号	A(mm)	Finiture-Oberflache Finishes-表面
	300	mill finish
	300	painted

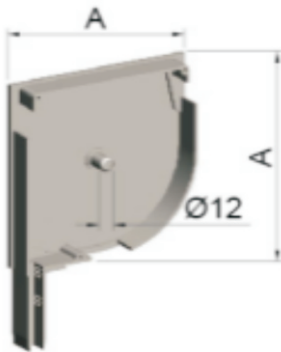

Paia di fianchi(DX e SN), IL Cerchio 1/4  
 Paar blendkappen(rechts und links),Der kreis 1/4  
 Pair of End Cap (Leff & Right), 1/4 round  
 1/4圆弧铝端盖

Articolo-Art.No.-编号	A(mm)	Finiture-Oberflache Finishes-表面
	137	mill finish
	137	painted
	150	mill finish
	150	painted
	180	mill finish
	180	painted
	205	mill finish
	205	painted



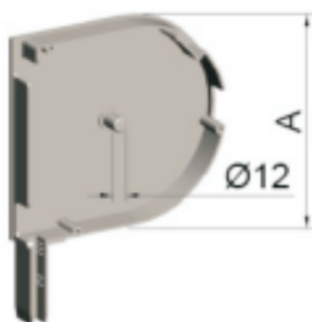

Paia di fianchi(DX e SN), IL Cerchio ½  
 Paar blendkappen(rechts und links),Der kreis ½  
 Pair of End Cap (Leff & Right), 1/2 round  
 1/2圆弧铝端盖

Articolo-Art.No.-编号	A(mm)	Finiture-Oberfläche Finishes-表面
	137	mill finish
	137	painted
	150	mill finish
	150	painted
	165	mill finish
	165	painted
	180	mill finish
	180	painted
	205	mill finish
	205	painted

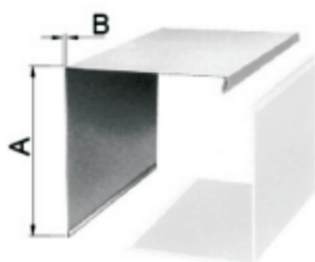

Cassetta esterno in alluminio 90°,per fianchi 404.90...1  
 Aluminium Kästen 90° ,für blendkappen 404.90...1  
 Aluminium Box 90° ,for end caps 404.90...1 series  
 90° 罩壳，配用404.90...1系列端盖

Articolo-Art.No.-编号	A(mm)	B(mm)
	137	0.8
	150	0.8
	165	0.8
	180	0.8
	205	0.8

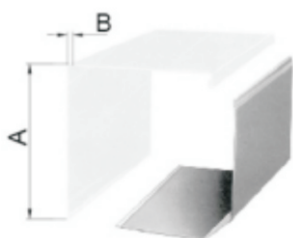

Cassetta esterno in alluminio 45°,per fianchi 404.45...1  
 Aluminium Kästen 45° ,für blendkappen 404.45...1  
 Aluminium Box 45° ,for end caps 404.45...1 series  
 45° 罩壳，配用404.45...1系列端盖

Articolo-Art.No.-编号	A(mm)	B(mm)
	137	0.8
	150	0.8
	165	0.8
	180	0.8
	205	0.8

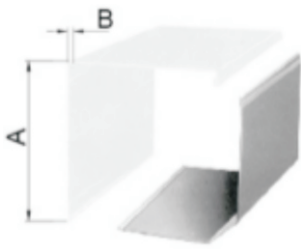

Cassetta esterno in alluminio 45°, per fianchi 404.45...2  
 Aluminium Kästen 45° ,für blendkappen 404.45...2  
 Aluminium Box 45° ,for end caps 404.45...2 series  
 45° 罩壳， 配用404.45...2系列端盖

Articolo-Art.No.-编号	A(mm)	B(mm)
	137	0.8
	150	0.8
	165	0.8
	180	0.8
	205	0.8

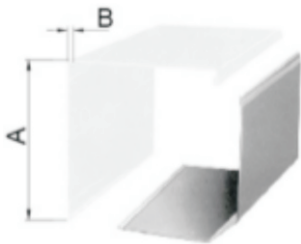

Cassetta esterno in alluminio, per fianchi 404.45.232P  
 Aluminium Kästen 45° ,für blendkappen 404.45.232P  
 Aluminium Box 45° ,for end caps 404.45.232P  
 45° 罩壳， 配用404.45.232P的230mm端盖

Articolo-Art.No.-编号	A(mm)	B(mm)
	230	0.8

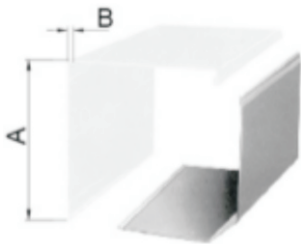

Cassetta esterno in alluminio 45°, per fianchi 404.45...3  
 Aluminium Kästen 45° ,für blendkappen 404.45...3  
 Aluminium Box 45° ,for end caps 404.45...2 series  
 45° 罩壳， 配用404.45...3系列端盖

Articolo-Art.No.-编号	A(mm)	B(mm)
	180	0.8
	205	0.8
	250	1.0
	300	1.0

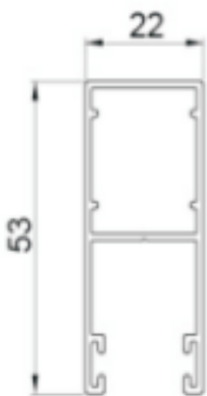

Guida in alluminio (senza spazzolino)  
 Alu-Führungsschiene (ohne Bürste)  
 Aluminum Guide Rail (without brush seal)  
 铝合金导轨 (不含毛条)

Articolo-Art. No.-编号	厚度	Nota-Anm-Remarks 备注
	1.2	Bianco-Weiss-White-白色 Altri colori Disponibili-Andere Farben zur auswahl, other colars availabe-也可定制颜色



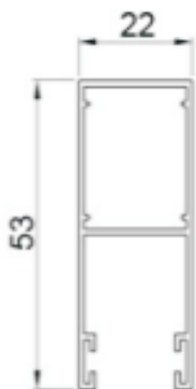

Guida in alluminio(senza spazzolino)  
Alu-Führungsschiene(ohne Bürste)  
Aluminum Guide Rail(without brush seal)  
铝合金导轨 (不含毛条)

Articolo-Art. No.-编号	厚度	Nota-Anm-Remarks 备注
	1.0	Bianco-Weiss-White-白色 Altri colari Disponibili-Andere Farben zur auswahl, other colars available-也可定制颜色

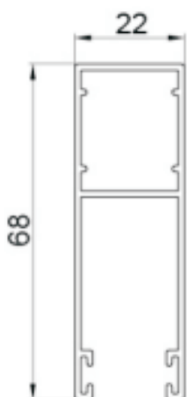

Guida in alluminio(senza spazzolino)  
Alu-Führungsschiene(ohne Bürste)  
Aluminum Guide Rail(without brush seal)  
铝合金导轨 (不含毛条)

Articolo-Art. No.-编号	厚度	Nota-Anm-Remarks 备注
	1.2	Bianco-Weiss-White-白色 Altri colari Disponibili-Andere Farben zur auswahl, other colars available-也可定制颜色

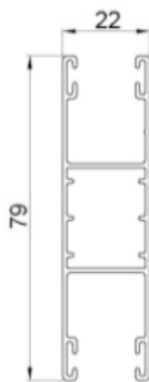

Guida in alluminio(senza spazzolino)  
Alu-Führungsschiene(ohne Bürste)  
Aluminum Guide Rail(without brush seal)  
铝合金导轨 (不含毛条)

Articolo-Art. No.-编号	厚度	Nota-Anm-Remarks 备注
	1.0	Bianco-Weiss-White-白色 Altri colari Disponibili-Andere Farben zur auswahl, other colars available-也可定制颜色

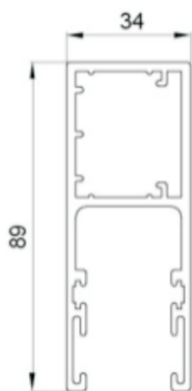

Guida in alluminio(senza spazzolino)  
Alu-Führungsschiene(ohne Bürste)  
Aluminum Guide Rail(without brush seal)  
铝合金导轨 (不含毛条)

Articolo-Art. No.-编号	厚度	Nota-Anm-Remarks 备注
	2.5	Bianco-Weiss-White-白色 Altri colari Disponibili-Andere Farben zur auswahl, other colars available-也可定制颜色

Profilo di plastica per guida in all.in rotoli, per 404.GD.89  
Plastik-Profil fÜhrungsschienen in rollen, fÜr 404.GD.89  
Plastic profile strip for Aluminum Guide Rail 404.GD.89  
89铝合金导轨用胶条



Articolo-Art. No.-编号	Nota-Anm-Remarks 备注
	per/fÜr/for/用于404.GD.89

Profilo di plastica per Terminale Alluminio  
Plastik-Profil fÜr Unten Profil  
Plastic profile strip for Bottom Profile  
铝合金底梁用胶条



Articolo-Art. No.-编号	Nota-Anm-Remarks 备注
	per/fÜr/for/用于404.BM

Tappo per guida in alluminio StÖpsel aus kunststoff fÜr Alu-fÜhrungsschiene  
Guide Rail End Stopper 导轨底塞

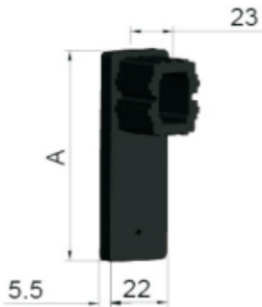

Articolo-Art. No.-编号	Nota-Anm-Remarks 备注		
	IL Colore-Farbe Colour-颜色	A mm	Nota-Anm Remarks-备注
	Nero -Schwarz- Black-黑色 Altri colori Disponibili Andere Farben zur auswahl other colors availabe 也可定制颜色	53	Per 404.GD.53 F ü r 404.GD.53 For 404.GD.53 配套404.GD.53
		68	Per 404.GD.68 F ü r 404.GD.68 For 404.GD.68 配套404.GD.68

Sappo Per guida in alluminio  
Bürste fÜr Alu-fÜhrungsschienen in rollen  
Pile Weather Strip for Aluminum Guide Rail  
铝合金导轨用毛条

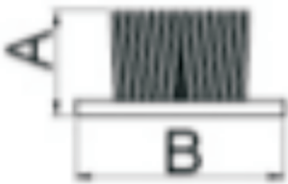

Articolo-Art. No.-编号	A ( mm )	B ( mm )
	5.5	6.8

Tappo Plastica per guide alluminio  
StÖpsel aus kunststoff fÜr Alu-fÜhrungsschiene  
Cap for Aluminum Guide Rail 铝合金导轨用塑料帽



Articolo-Art. No.-编号	D ( mm )	IL Colore-Farbe-Colour-颜色
	16	Bianco-Weiss-White-白色 Altri colori Disponibili-Andere Farben zur auswahl, other colars availabe-也可定制颜色



Tappo Plastica per Cassonetto alluminio  
Stöpsel aus kunststoff für Aluminium Kästen  
Cap for Aluminum Box  
铝合金罩壳用塑料帽

Articolo-Art. No.-编号	D ( mm )	IL Colore-Farbe-Colour-颜色
	16	Bianco-Weiss-White-白色 Altri colori Disponibili-Andere Farben zur auswahl, other colars availabe-也可定制颜色

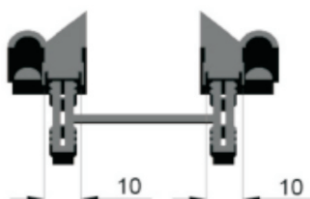

Invito in Plastica Per Fianchi MINI  
Paar Kunststoff einlaufstutzen  
Entry Guide  
通用型引导头

Articolo-Art. No.-编号	IL Colore-Farbe-Colour-颜色
	Bianco-Weiss-White-白色 Altri colori Disponibili-Andere Farben zur auswahl, other colars availabe-也可定制颜色

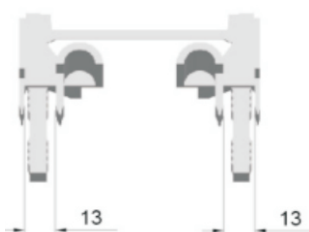

Invito in Plastica Per Fianchi MINI  
Paar Kunststoff einlaufstutzen  
Entry Guide  
通用型引导头

Articolo-Art. No.-编号	IL Colore-Farbe-Colour-颜色
	Bianco-Weiss-White-白色 Altri colori Disponibili-Andere Farben zur auswahl, other colars availabe-也可定制颜色

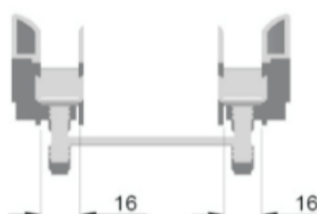

Invito in Plastica Per Fianchi 250,300  
Paar Kunststoff blendkappen 250,300  
Entry Guide for End Cap 250,300,large leg  
大尺寸腿的端盖用引导头

Articolo-Art. No.-编号	IL Colore-Farbe-Colour-颜色
	Bianco-Weiss-White-白色 Altri colori Disponibili-Andere Farben zur auswahl, other colars availabe-也可定制颜色

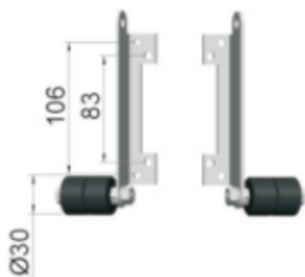

Rullino d'invito Dx e SIN, Per Fianchi 250,300  
Paar Einlaufrollen, für Groß e blendkappen 250,300  
Entry Guide Roller, for End Cap 250,300,large leg  
引导轮, 配套250, 300的大尺寸腿端盖使用

Articolo-Art. No.-编号	IL Colore-Farbe-Colour-颜色
	Bianco-Weiss-White-白色 Altri colori Disponibili-Andere Farben zur auswahl, other colars availabe-也可定制颜色



Tappi d'arresto in plastica con vite a dado  
Tappi d'arresto in plastica con vite a dado  
Plastic Stopper, with screw and nut  
圆锥形止动

Articolo-Art. No.-编号	IL Colore-Farbe-Colour-颜色
	Bianco-Weiss-White-白色 Altri colori Disponibili-Andere Farben zur auswahl, other colors available-也可定制颜色



Tappi d'arresto in plastica con vite a dado  
Anschlagstopfen aus kunststoff mit schraube  
Plastic Stopper, with screw and nut  
圆锥形止动

Articolo-Art. No.-编号	IL Colore-Farbe-Colour-颜色
	Bianco-Weiss-White-白色 Altri colori Disponibili-Andere Farben zur auswahl, other colors available-也可定制颜色



Tappi d'arresto in plastica con vite a dado  
Anschlagstopfen aus kunststoff mit schraube  
Plastic Stopper, with screw and nut  
圆锥形止动

Articolo-Art. No.-编号	IL Colore-Farbe-Colour-颜色
	Bianco-Weiss-White-白色 Altri colori Disponibili-Andere Farben zur auswahl, other colors available-也可定制颜色



Tappi d'arresto in plastica con vite a dado  
Anschlagstopfen aus kunststoff mit schraube  
Plastic Stopper, with screw and nut  
圆锥形止动

Articolo-Art. No.-编号	IL Colore-Farbe-Colour-颜色
	Bianco-Weiss-White-白色 Altri colori Disponibili-Andere Farben zur auswahl, other colors available-也可定制颜色

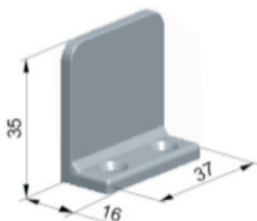

Tappi d'arresto in plastica Anschlagstopfen aus kunststoff  
Plastic Stopper. L形止动

Articolo-Art. No.-编号	IL Colore-Farbe-Colour-颜色
	Bianco-Weiss-White-白色 Altri colori Disponibili-Andere Farben zur auswahl, other colors available-也可定制颜色

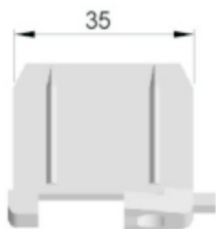

Parte d'arresto in plastica Anschlagstopfen aus kunststoff  
Plastic Stopping part. 内置式止动

Articolo-Art. No.-编号	IL Colore-Farbe-Colour-颜色
	Bianco-Weiss-White-白色



Terminale alluminio Unten Profil Boffom Profile  
底梁

Articolo-Art. No.-编号	Nota-Anm-Remarks 备注
	per/für/for/用于403.EST.37...45

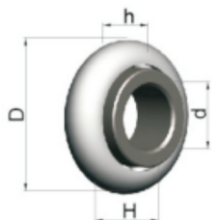

Cuscinetto,OD28mm Kugellager,OD28mm Ball Bearing with plastic inner ring,  
Od28mm 塑料内圈轴承, 外径28mm

Articolo-Art. No.-编号	Dimension(mm)				Cone Material
	d	D	H	h	
	12	28.2	10	8.2	Plastic

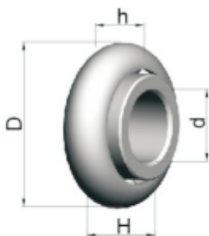

Cuscinetto,OD28mm Kugellager,OD28mm Ball Bearing with iron inner ring,  
Od28mm 铁内圈轴承, 外径28mm

Articolo-Art. No.-编号	Dimension(mm)				Cone Material
	d	D	H	h	
	12	28.2	10	8.2	Steel

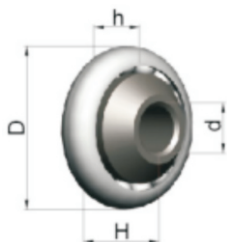

Cuscinetto,OD40mm Kugellager,OD40mm Ball Bearing with plastic inner ring,  
Od40mm 塑料内圈轴承, 外径40mm

Articolo-Art. No.-编号	Dimension(mm)				Cone Material
	d	D	H	h	
	12	40	16.5	10	Plastic

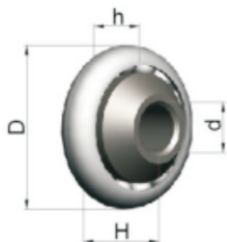

Cuscinetto,OD42mm Kugellager,OD42mm Ball Bearing with plastic inner ring,  
Od42mm 塑料内圈轴承, 外径42mm

Articolo-Art. No.-编号	Dimension(mm)				Cone Material
	d	D	H	h	
	12	42	15	10	Plastic

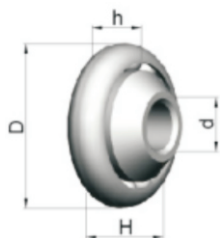

Cuscinetto,OD42mm Kugellager,OD42mm Ball Bearing with iron inner ring,  
Od42mm 铁内圈轴承, 外径42mm

Articolo-Art. No.-编号	Dimension(mm)				Cone Material
	d	D	H	h	
	12	42	15	10	Steel

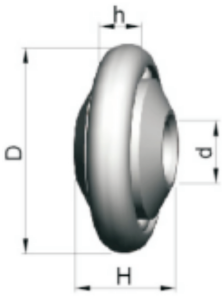

Cuscinetto, OD42mm Kugellager, OD42mm Ball Bearing with iron inner ring,  
Od42mm 铁内圈轴承, 外径42mm

Articolo-Art. No.-编号	Dimension(mm)				Cone Material
	d	D	H	h	
	12	42	18	10	Steel

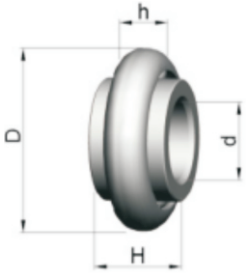

Cuscinetto, OD42mm Kugellager, OD42mm Ball Bearing with iron inner ring,  
Od42mm 铁内圈轴承, 外径42mm

Articolo-Art. No.-编号	Dimension(mm)				Cone Material
	d	D	H	h	
	18	42	18	10	Steel

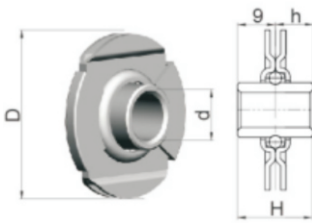

Cuscinetto a sfere per innesto 30mm Kugellager, für 30mm Einschnitt tapered  
Bearing for 30mm gain 冲压轴承

Articolo-Art. No.-编号	Dimension(mm)				Cone Material
	d	D	H	h	
	12	42	18	9	Steel
	12	42	23	14	Steel
	12	42	25	16	Steel

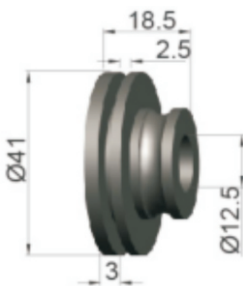

Boccola in Nylon per innesto 30mm  
Büchse aus Nylon für 30mm Einschnitt  
Nylon bushing for 30mm gain 尼龙轮子

Articolo-Art. No.-编号	Materiale-material-material-材质
	Nylon

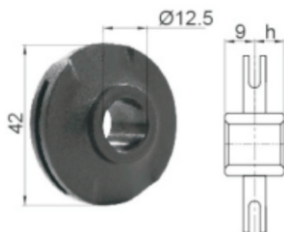

Boccola in Nylon per innesto 30mm  
Büchse aus Nylon für 30mm Einschnitt  
Nylon bushing for 30mm gain 尼龙轮子

Articolo-Art. No.-编号	Materiale-material-material-材质
	Nylon
	Nylon

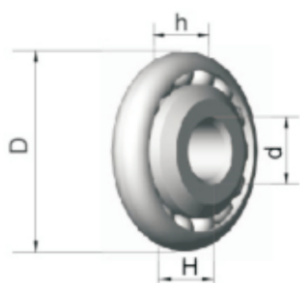

Cuscinetto, OD42mm  
Kugellager, OD42mm  
Ball Bearing with iron inner ring, OD42mm

Articolo-Art. No.-编号	Dimension(mm)				Cone Material
	d	D	H	h	
	12	42	12	10	

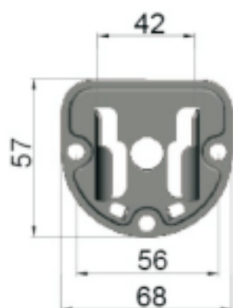

Supporto per cuscinetto Od42  
Anschraublager für Kugellager Od42  
Bracket for bearing Od42 外径42轴承用支架

Articolo-Art. No.-编号	Materiale-material-material-材质
	Ferro-Stahl-Steel-碳钢

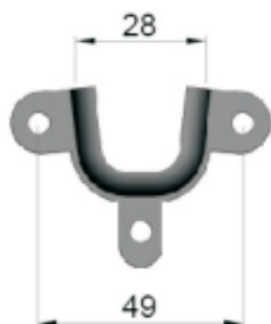

Supporto per cuscinetto OD42  
Anschraublager für Kugellager OD42  
Bracket for bearing OD42 外径42轴承用支架

Articolo-Art. No.-编号	Materiale-material-material-材质
	Ferro-Stahl-Steel-碳钢

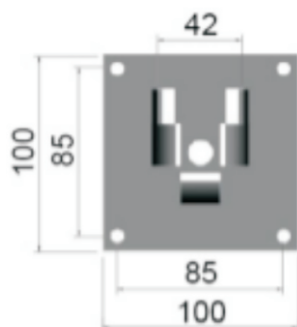

Piastra per fianchi  
Lagerplatte für Gro ß e blendkappen  
Bracket for bearing OD42 for king size end caps 外径42轴承支架

Articolo-Art. No.-编号	Materiale-material-material-材质
	Ferro-Stahl-Steel-碳钢

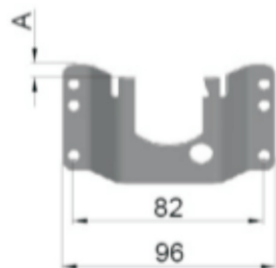

Support a legno per 405.712...  
Aufschraublager für 405.712...  
Bearing Bracket for 405.712...  
405.712...系列配套支架

Articolo-Art. No.-编号	Materiale-material-material-材质
	Ferro-Stahl-Steel-碳钢

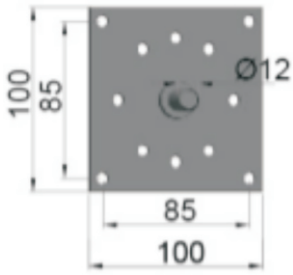

Piastra per fianchi  
Lagerplatte für Gro ß e blendkappen  
Support plate for king size end caps  
支撑板

Articolo-Art. No.-编号	Materiale-material-material-材质
	Ferro-Stahl-Steel-碳钢



Support da avvitare per cuscinetto Od42  
Anschraublager für kugellager Od42  
Screw type bracket for bearing Od42  
轴承支架, 使用42mm外径的轴承

Articolo-Art. No.-编号	Materiale-material-material-材质
	Ferro-Stahl-Steel-碳钢



Support da avvitare per cuscinetto Od42  
Anschraublager für kugellager Od42  
Screw type bracket for bearing Od42  
轴承支架, 使用42mm外径的轴承

Articolo-Art. No.-编号	Materiale-material-material-材质
	Ferro-Stahl-Steel-碳钢

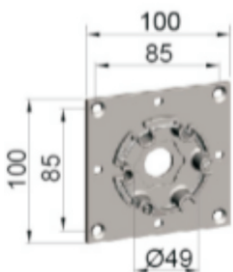

Piastra per fianchi  
Lagerplatte für Gro ß e blendkappen  
Support plate for king size end caps  
管状电机安装座

Articolo-Art. No.-编号	Materiale-material-material-材质
	Ferro-Stahl-Steel-碳钢

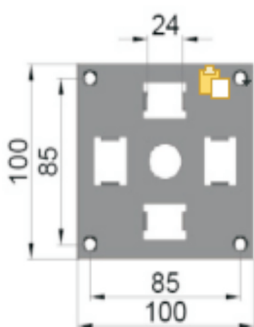

Piastra per fianchi  
Lagerplatte für Gro ß e blendkappen  
Support plate for king size end caps  
管状电机安装座

Articolo-Art. No.-编号	Materiale-material-material-材质
	Ferro-Stahl-Steel-碳钢



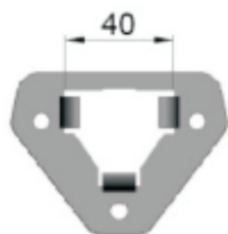

Support per cuscinetto Od40  
Anschraublager für Kugellager Od40  
Bracket for bearing Od40 外径40轴承用支座

Articolo-Art. No.-编号	Materiale-material-material-材质
	Ferro-Stahl-Steel-碳钢



Support da avvitare per cuscinetto Od42  
Anschraublager für Kugellager Od42  
Screw type bracket for bearing Od42 轴承支架, 使用42mm外径的轴承

Articolo-Art. No.-编号	Materiale-material-material-材质
	Ferro-Stahl-Steel-碳钢

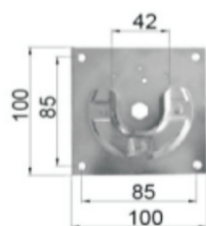

Piastra per fianchi  
Lagerplatte für Große blendkappen  
Support plate for king size end caps 外径42轴承支座

Articolo-Art. No.-编号	Materiale-material-material-材质
	Ferro-Stahl-Steel-碳钢

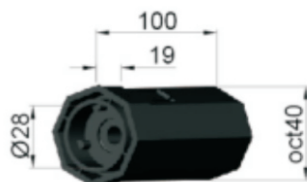

Calotta oct40 per cuscinetto Od28  
Kapsel oct40 für Kugellager Od28  
Plastic cap oct40 with bearing housing dia.28mm 塑料尾插, oct40,配OD28轴承

Articolo-Art. No.-编号	IL Colore-Farbe-Colour-颜色
	Bianco-Weiss-White-白色 Nero-schwarz-black-黑色



Calotta oct40 per cuscinetto Od28  
Kapsel oct40 für Kugellager Od28  
Plastic cap oct40 with bearing housing dia.28mm 塑料尾插, oct40,配OD28轴承

Articolo-Art. No.-编号	IL Colore-Farbe-Colour-颜色
	Bianco-Weiss-White-白色 Nero-schwarz-black-黑色



Calotta oct40 con perno Ø12  
Kapsel oct40 mit stift Ø12  
Plastic cap oct40 with with pivot Ø12 塑料尾插, oct40,配Ø12的销子

Articolo-Art. No.-编号	IL Colore-Farbe-Colour-颜色
	Bianco-Weiss-White-白色 Nero-schwarz-black-黑色

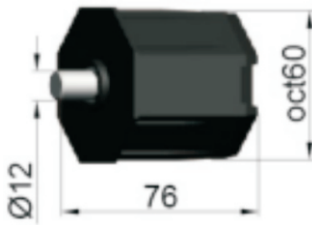

Calotta oct40 con perno Ø12  
Kapsel oct40 mit stift Ø12  
Plastic cap oct40 with with pivot Ø12 塑料尾插, oct460,配Ø12的销子

Articolo-Art. No.-编号	IL Colore-Farbe-Colour-颜色
	Bianco-Weiss-White-白色 Nero-schwarz-black-黑色

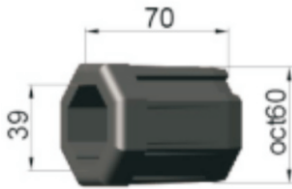

Adattatore oct40/oct60  
Aufsteckringe oct40/oct60  
Plastic Adapter, oct40/oct60 塑料转换适配件, oct40/oct60

Articolo-Art. No.-编号	IL Colore-Farbe-Colour-颜色
	Bianco-Weiss-White-白色 Nero-schwarz-black-黑色

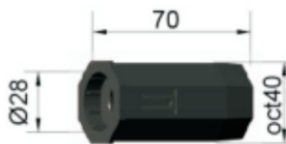

Calotta oct40 per cuscinetto Od28  
Kapsel oct40 für Kugellager Od28  
Plastic cap oct40 with bearing housing dia.28mm 塑料尾插, oct40,配OD28轴承

Articolo-Art. No.-编号	IL Colore-Farbe-Colour-颜色
	Bianco-Weiss-White-白色 Nero-schwarz-black-黑色

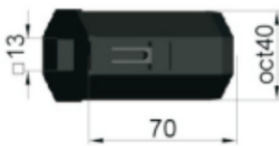

Calotta in plastica oct40 con foro 13  
Kunststoff Walzenkapsel oct40 mit loch 13  
Plastic cap oct40 with Hole 13 塑料尾插, 40八角管用,带13\*13mm方孔

Articolo-Art. No.-编号	IL Colore-Farbe-Colour-颜色
	Bianco-Weiss-White-白色 Nero-schwarz-black-黑色

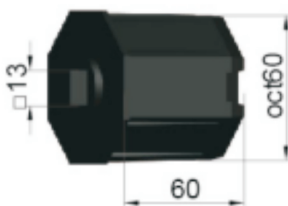

Calotta in plastica oct40 con foro 13  
Kunststoff Walzenkapsel oct40 mit loch 13  
Plastic cap oct40 with Hole 13 塑料尾插, 60八角管用,带13\*13mm方孔

Articolo-Art. No.-编号	IL Colore-Farbe-Colour-颜色
	Bianco-Weiss-White-白色 Nero-schwarz-black-黑色

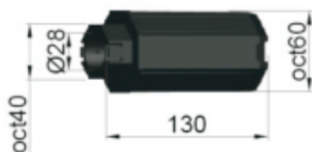

Calotta oct60 per cuscinetto Od28  
Kapsel oct60 für Kugellager Od28  
Plastic cap oct60 with bearing housing dia.28mm 塑料尾插, oct60,配OD28轴承

Articolo-Art. No.-编号	IL Colore-Farbe-Colour-颜色
	Bianco-Weiss-White-白色 Nero-schwarz-black-黑色

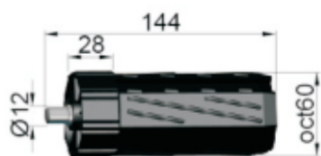

Calotta oct60 con perno  $\varnothing 12$   
Kapsel oct60 mit stift  $\varnothing 12$   
Plastic cap oct60 with pivot  $\varnothing 12$  塑料尾插, oct60, 配  $\varnothing 12$  的销子

Articolo-Art. No.-编号	IL Colore-Farbe-Colour-颜色
	Bianco-Weiss-White-白色 Nero-schwarz-black-黑色



Calotta oct40 con perno  $\varnothing 12$   
Kapsel oct40 mit stift  $\varnothing 12$   
Plastic cap oct40 with pivot  $\varnothing 12$  塑料尾插, oct40, 配  $\varnothing 12$  的销子

Articolo-Art. No.-编号	IL Colore-Farbe-Colour-颜色
	Bianco-Weiss-White-白色 Nero-schwarz-black-黑色



Calotta oct60 con perno  $\varnothing 12$   
Kapsel oct60 mit stift  $\varnothing 12$   
Plastic cap oct60 with pivot  $\varnothing 12$  塑料尾插, oct60, 配  $\varnothing 12$  的销子

Articolo-Art. No.-编号	IL Colore-Farbe-Colour-颜色
	Bianco-Weiss-White-白色 Nero-schwarz-black-黑色



Calotta oct60 con perno  $\varnothing 12$   
Kapsel oct60 mit stift  $\varnothing 12$   
Plastic cap oct60 with pivot  $\varnothing 12$  塑料尾插, oct60, 配  $\varnothing 12$  的销子

Articolo-Art. No.-编号	IL Colore-Farbe-Colour-颜色
	Bianco-Weiss-White-白色 Nero-schwarz-black-黑色

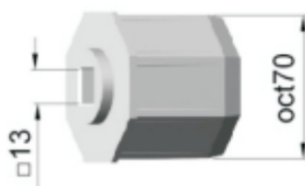

Calotta in alluminio oct70 con foro  $\blacksquare 13$   
Aluminium Walzenkapsel oct70 mit loch  $\blacksquare 13$   
Aluminum cap oct 70 with hole  $\blacksquare 13$  铝合金尾插, 70八角管用, 带  $13 \times 13$  mm 方孔

Articolo-Art. No.-编号	Materiale-material-material-材质
	alluminio-aluminium-aluminum-铝合金

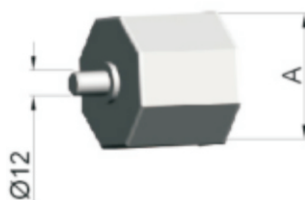

Calotta per rullo zincata con perno  $\varnothing 12$   
Verzinkte stahlkapsel mit stift  $\varnothing 12$   
Steel cap with pivot  $\varnothing 12$  铁尾插, 带外径 12 mm 销子

Articolo-Art. No.-编号	A(M)	Materiale-material-material-材质
	oct60	steel
	oct70	steel

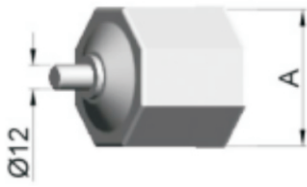

Calotta per rullo zincata con perno Ø12  
Verzinkte stahlkapsel mit stift Ø12  
Steel cap with pivot Ø12 铁尾插，带外径12mm销子

Articolo-Art. No.-编号	A(M)	Materiale-material-material-材质
	oct60	steel
	oct70	steel

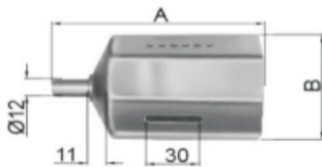

Calotta registrabile zincata(reg.max=30mm)  
Verstellbare stahlkapsel(verst.max=30mm)  
Adjustable steel cap(max.adj=30mm) 可调式铁尾插 (最大调节长度=30mm)

Articolo-Art. No.-编号	A(M)	Materiale-material-material-材质
	78	oct60
	108	oct70

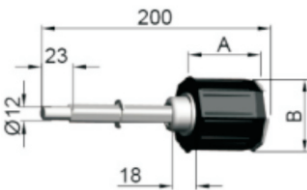

Calotta registrabile zincata(reg.max=90mm)  
Verstellbare stahlkapsel(verst.max=90mm)  
Adjustable steel cap(max.adj=90mm) 可调式铁尾插 (最大调节长度=90mm)

Articolo-Art. No.-编号	A(M)	B(M)
	60	oct60
	60	oct70

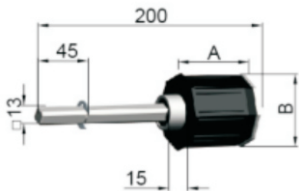

Calotta registrabile zincata(reg.max=90mm)  
Verstellbare stahlkapsel(verst.max=90mm)  
Adjustable steel cap(max.adj=90mm) 可调式铁尾插 (最大调节长度=90mm)

Articolo-Art. No.-编号	A(M)	B(M)
	60	oct60
	60	oct70

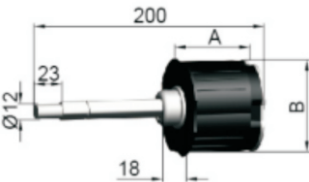

Calotta registrabile zincata(reg.max=90mm)  
Verstellbare stahlkapsel(verst.max=90mm)  
Adjustable steel cap(max.adj=90mm) 可调式铁尾插 (最大调节长度=90mm)

Articolo-Art. No.-编号	A(M)	B(M)
	60	84

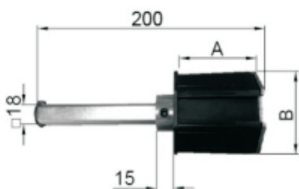

Calotta registrabile zincata(reg.max=90mm)  
Verstellbare stahlkapsel(verst.max=90mm)  
Adjustable steel cap(max.adj=90mm) 可调式铁尾插 (最大调节长度=90mm)

Articolo-Art. No.-编号	A(M)	B(M)
	60	oct70

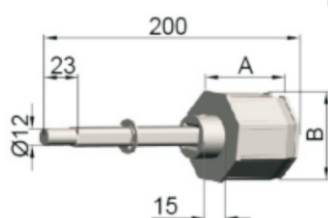

Calotta registrabile in alluminio(reg.max=90mm)  
Verstellbare kapsel aus aluminium(verst.max=90mm)  
Adjustable Aluminum Idler(max.adj=90mm)  
可调式铝合金尾插 (最大调节长度=90mm)

Articolo-Art. No.-编号	A(M)	B(M)
	50	oct60
	50	oct70

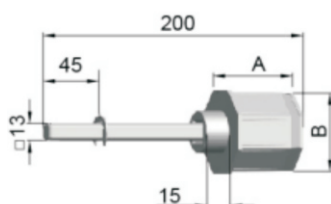

Calotta registrabile in alluminio(reg.max=90mm)  
Verstellbare kapsel aus aluminium(verst.max=90mm)  
Adjustable Aluminum Idler(max.adj=90mm)  
可调式铝合金尾插 (最大调节长度=90mm)

Articolo-Art. No.-编号	A(M)	B(M)
	50	oct60
	50	oct70

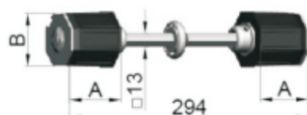

Caloffa doppia registrabile  
Verstellbare doppelkapsel  
Double-Adjustable Plastic Idler  
双头可调式塑料过渡尾插

Articolo-Art. No.-编号	A(M)	B(M)
	60	oct60
	60	oct70

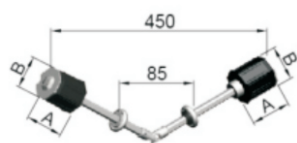

Caloffa doppia registrabile  
Verstellbare doppelkapsel  
Double-Adjustable Plastic Idler  
双头45°可调式塑料过渡尾插

Articolo-Art. No.-编号	A(M)	B(M)
	60	oct60
	60	oct70

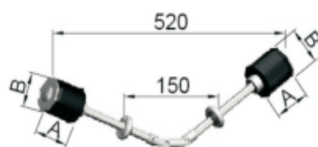

Caloffa doppia registrabile con snodo cardanico  
Verstellbare doppelkapsel mit Kardangelenk  
Double-Adjustable Plastic Idler,with cardan joint  
双头45°可调式塑料过渡尾插

Articolo-Art. No.-编号	A(M)	B(M)
	60	oct60
	60	oct70

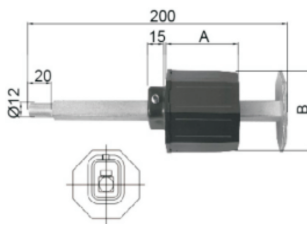

Calotta registrabile in plastica(reg.max=100mm)  
Verstellbare kapsel aus kunststoff(verst.max=100mm)  
Adjustable plastic Idler(max.adj=100mm) 可调式塑料尾插 (最大调节长度=100mm)

Articolo-Art. No.-编号	A(M)	B(M)
	60	oct60

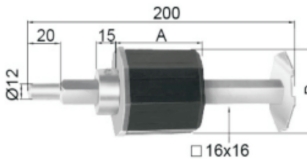

Calotta registrabile in plastica(reg.max=90mm)  
Verstellbare kapsel aus kunststoff(verst.max=90mm)  
Adjustable plastic Idler(max.adj=90mm) 可调式塑料尾插 (最大调节长度=90mm)

Articolo-Art. No.-编号	A(M)	B(M)
	60	oct60
	60	oct70

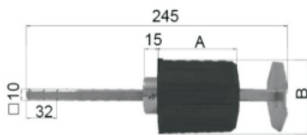

Calotta registrabile in plastica(reg.max=120mm)  
Verstellbare kapsel aus kunststoff(verst.max=120mm)  
Adjustable plastic Idler(max.adj=120mm) 可调式塑料尾插 (最大调节长度=120mm)

Articolo-Art. No.-编号	A(M)	B(M)
	60	oct60

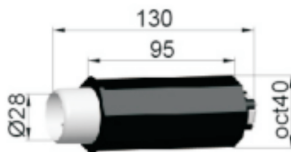

Calotta oct40 per cuscinetto OD28 con molla  
Kapsel oct40 für Kugellager OD28 mit Im Frühjah  
Plastic cap oct40 for bearing OD28,with spring 塑料尾插, oct40,配OD28轴承

Articolo-Art. No.-编号	IL Colore-Farbe-Colour-颜色
	Bianco-Weiss-White-白色 Nero-schwarz-black-黑色

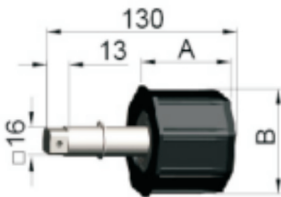

Calotta oct40 per cuscinetto OD28 con molla  
Kapsel oct40 für Kugellager OD28 mit Im Frühjah  
Plastic cap oct40 for bearing OD28,with spring 塑料尾插, oct40,配OD28轴承

Articolo-Art. No.-编号	A(M)	B(M)
	60	oct60
	60	oct70

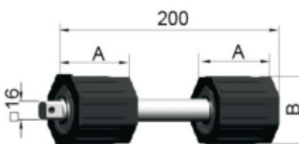

Caloffa doppia con Cuscinetto  
Doppelkapsel mit Kugellage  
Double plastic Idler,with bearings 重型双塑料尾插

Articolo-Art. No.-编号	A(M)	B(M)
	60	oct60
	60	oct70

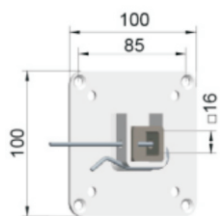

Supporto con fromolla per asse ■16  
Hilfsfderlager für Der Schacht ■16  
Mounting Bracket for shaft ■16  
安装板, 与圈16的方轴配套

Articolo-Art. No.-编号	Nota-Anm-Remarks 备注
	per/für/for/用于 asse/schacht/shaft/方轴 ■16

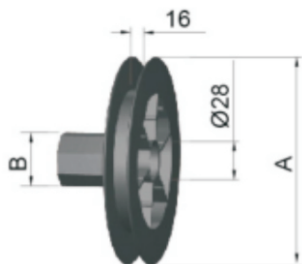

Plueggia in plastica per cuscinetto Ø28  
Kunststoff gurtscheibe für kugellager Ø28  
Plastic Pulley with bearing housing Ø28  
塑料轮盘, 可配28mm外径轴承

Articolo-Art. No.-编号	A(M)	B(M)
	90	oct40
	110	oct40
	140	oct40
	155	oct40

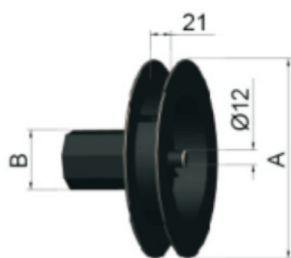

Puleggia in plastica oct40 con perno Ø12  
Kunststoff gurtscheibe oct40 mit stift Ø12  
Plastic pulley oct40 with pivot Ø12  
塑料轮盘, oct40,带Ø12的销子

Articolo-Art. No.-编号	A(M)	B(M)
	118	oct40
	136	oct40

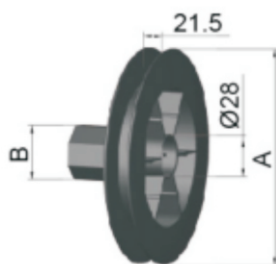

Puleggia in plastica per cuscinetto Ø28  
Kunststoff gurtscheibe für kugellager Ø28  
Plastic pulley with bearing housing Ø28  
塑料轮盘, 可配28mm外径轴承

Articolo-Art. No.-编号	A(M)	B(M)
	118	oct40
	136	oct40



Puleggia in plastica per calotte art 407.101.286  
Kunststoff gurtscheibe für art.407.101.286  
Plastic pulley for cap 407.101.286  
塑料轮盘, 可配407.101.286配套使用

Articolo-Art. No.-编号	A(M)	B(M)
	170	oct60
	190	oct60
	210	oct60

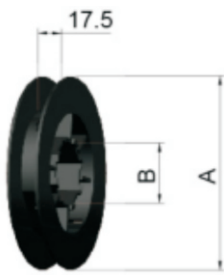

Puleggia in plastica per calotte art 407.101.284  
Kunststoff gurtscheibe für art.407.101.284  
Plastic pulley for cap 407.101.284 塑料轮盘, 可配407.101.284配套使用

Articolo-Art. No.-编号	A(M)	B(M)
	125	oct40
	140	oct40
	150	oct40

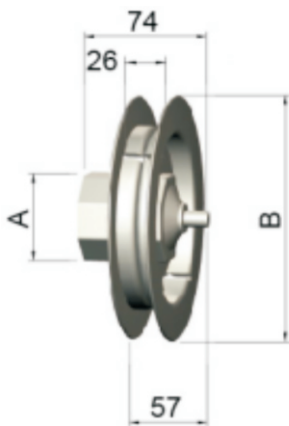

Puleggia in ferro con perno Ø12  
Stahlgurtscheibe mit sfiiff Ø12  
Steel pulley with pivot Ø12 铁轮盘, 带Ø12的销子

Articolo-Art. No.-编号	A(M)	B(M)
	oct60	160
	oct60	180
	oct60	200
	oct60	160
	oct60	180
	oct60	200

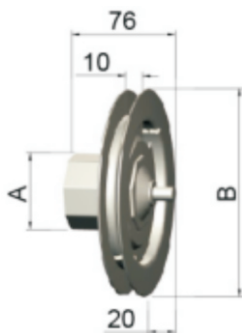

Puleggia in ferro con perno Ø12, per fune  
Stahlgurtscheibe mit sfiiff Ø12, für drahtseil  
Steel pulley with pivot Ø12, for steel wire 铁轮盘, 带Ø12的销子, 与钢丝绳配用

Articolo-Art. No.-编号	A(M)	B(M)
	oct60	160

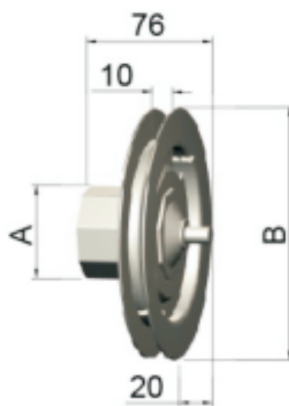

Puleggia in ferro con perno Ø28, per fune  
Stahlgurtscheibe mit sfiiff Ø28, für drahtseil  
Steel pulley with pivot Ø28, for steel wire 铁轮盘, 带Ø28的销子, 与钢丝绳配用

Articolo-Art. No.-编号	A(M)	B(M)
	oct40	150
	oct60	150
	oct70	150
	oct40	180
	oct60	180
	oct70	180



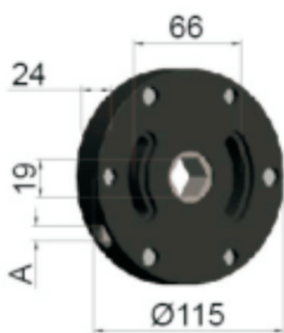

Argani, con carter in plastica  
Getriebe, mit gehäuse aus kunststoff  
Gear Winch, Round, Plastic Case  
圆形驱动盘, 塑料外壳

Articolo-Art. No.-编号	A mm	Rapporto Unterseztungsverhältnis Ratio-传动比	Nota-Anm-Remarks-备注	
	∅8	1:10	Con finecorsa Mit endanschlag With End Stroke 带限位	Giri max. 10 Max Umdrehungszahl 10 Max. 10 rotations 限位最大在10圈
	∅7	1:10		
	∅8	1:10	Non c'è finecorsa Keine endanschlag Without End Stroke 不带限位	N/A
	∅7	1:10		

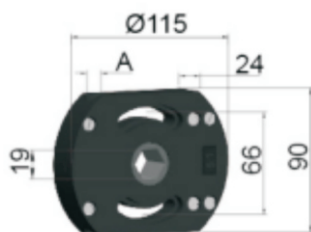

Argani "SYDNEY", con carter in plastica  
Getriebe "SYDNEY", mit gehäuse aus kunststoff  
Gear Winch "SYDNEY", Plastic Case  
“悉尼”款驱动盘, 塑料外壳

Articolo-Art. No.-编号	A mm	Rapporto Unterseztungsverhältnis Ratio-传动比	Nota-Anm-Remarks-备注	
	∅8	1:5	Con finecorsa Mit endanschlag With End Stroke 带限位	Giri max. 14 Max Umdrehungszahl 14 Max. 14 rotations 限位最大在14圈
	∅7	1:5		
	∅8	1:5	Non c'è finecorsa Keine endanschlag Without End Stroke 不带限位	N/A
	∅7	1:5		

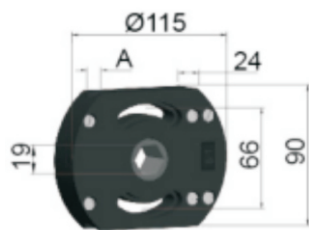

Argani "SYDNEY", con carter in plastica  
Getriebe "SYDNEY", mit gehäuse aus kunststoff  
Gear Winch "SYDNEY", Plastic Case  
“悉尼”款驱动盘, 塑料外壳

Articolo-Art. No.-编号	A mm	Rapporto Unterseztungsverhältnis Ratio-传动比	Nota-Anm-Remarks-备注	
	∅8	1:8	Con finecorsa Mit endanschlag With End Stroke 带限位	Giri max. 14 Max Umdrehungszahl 14 Max. 14 rotations 限位最大在14圈
	∅7	1:8		
	∅8	1:8	Non c'è finecorsa Keine endanschlag Without End Stroke 不带限位	N/A
	∅7	1:8		

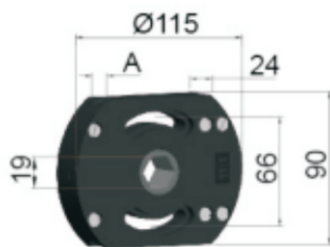

Argani "SYDNEY", con carter in plastica  
Getriebe "SYDNEY", mit gehäuse aus kunststoff  
Gear Winch "SYDNEY", Plastic Case  
“悉尼”款驱动盘, 塑料外壳

Articolo-Art. No.-编号	A mm	Rapporto Unterseztungsverhältnis Ratio-传动比	Nota-Anm-Remarks-备注	
	∅8	1:11	Con finecorsa Mit endanschlag With End Stroke 带限位	Giri max. 10 Max Umdrehungszahl 10 Max. 10 rotations 限位最大在10圈
	∅7	1:11		
	∅8	1:11	Non c'è finecorsa Keine endanschlag Without End Stroke 不带限位	N/A
	∅7	1:11		

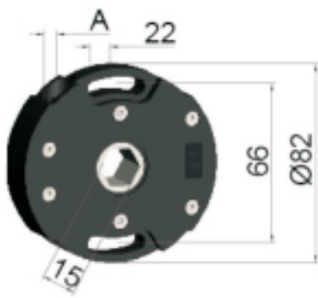

Argani, con carter in plastica  
Getriebe, mit gehäuse aus kunststoff  
Gear Winch, Round, Plastic Case  
圆形驱动盘, 塑料外壳

Articolo-Art. No.-编号	A mm	Rapporto Untersetzungverhältnis Ratio-传动比	Nota-Anm Remarks-备注
	Ø8	1:3	Non c'è finecorsa Keine endanschlag Without End Stroke 不带限位
	Ø7	1:3	

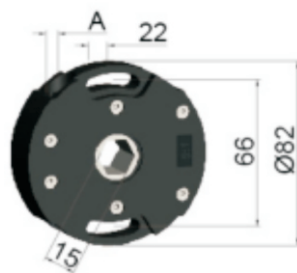

Argani, con carter in plastica  
Getriebe, mit gehäuse aus kunststoff  
Gear Winch, Round, Plastic Case  
圆形驱动盘, 塑料外壳

Articolo-Art. No.-编号	A mm	Rapporto Untersetzungverhältnis Ratio-传动比	Nota-Anm Remarks-备注
	Ø8	1:5	Non c'è finecorsa Keine endanschlag Without End Stroke 不带限位
	Ø7	1:5	

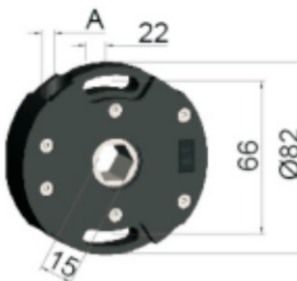

Argani, con carter in plastica  
Getriebe, mit gehäuse aus kunststoff  
Gear Winch, Round, Plastic Case  
圆形驱动盘, 塑料外壳

Articolo-Art. No.-编号	A mm	Rapporto Untersetzungverhältnis Ratio-传动比	Nota-Anm Remarks-备注
	Ø8	1:8	Non c'è finecorsa Keine endanschlag Without End Stroke 不带限位
	Ø7	1:8	

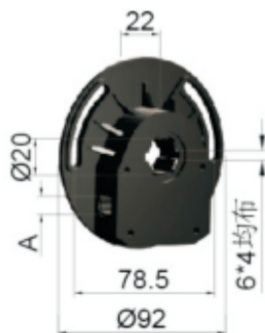

Argani, con carter in plastica  
Getriebe, mit gehäuse aus kunststoff  
Gear Winch, Round, Plastic Case  
圆形驱动盘, 塑料外壳

Articolo-Art. No.-编号	A mm	Rapporto Untersetzungverhältnis Ratio-传动比	Nota-Anm Remarks-备注
	Ø8	1:5	Non c'è finecorsa Keine endanschlag Without End Stroke 不带限位
	Ø7	1:5	

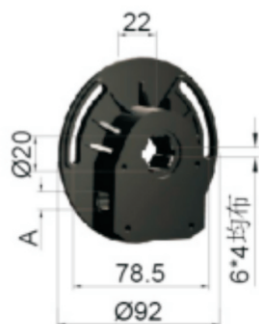

Argani, con carter in plastica  
Getriebe, mit gehäuse aus kunststoff  
Gear Winch, Round, Plastic Case 圆形驱动盘, 塑料外壳

Articolo-Art. No.-编号	A mm	Rapporto Untersetzungverhältnis Ratio-传动比	Nota-Anm Remarks-备注
	∅8	1:8	Non c'è finecorsa Keine endanschlag Without End Stroke 不带限位
	∅7	1:8	

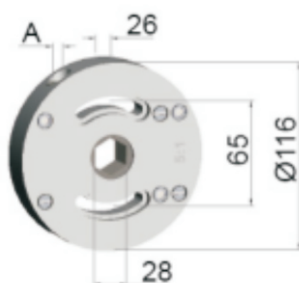

Argani, con carter in plastica  
Getriebe, mit gehäuse aus kunststoff  
Gear Winch, Round, Plastic Case 圆形驱动盘, 塑料外壳

Articolo-Art. No.-编号	A mm	Rapporto Untersetzungverhältnis Ratio-传动比	Nota-Anm-Remarks-备注	
			∅8	1:5
	∅7	1:5		
	∅8	1:5	Non c'è finecorsa Keine endanschlag Without End Stroke 不带限位	N/A
	∅7	1:5		

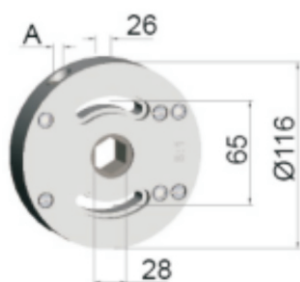

Argani, con carter in plastica  
Getriebe, mit gehäuse aus kunststoff  
Gear Winch, Round, Plastic Case 圆形驱动盘, 塑料外壳

Articolo-Art. No.-编号	A mm	Rapporto Untersetzungverhältnis Ratio-传动比	Nota-Anm-Remarks-备注	
			∅8	1:8
	∅7	1:8		
	∅8	1:8	Non c'è finecorsa Keine endanschlag Without End Stroke 不带限位	N/A
	∅7	1:8		

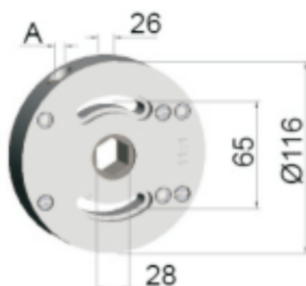

Argani, con carter in plastica  
Getriebe, mit gehäuse aus kunststoff  
Gear Winch, Round, Plastic Case 圆形驱动盘, 塑料外壳

Articolo-Art. No.-编号	A mm	Rapporto Untersetzungverhältnis Ratio-传动比	Nota-Anm-Remarks-备注	
			∅8	1:11
	∅7	1:11		
	∅8	1:11	Non c'è finecorsa Keine endanschlag Without End Stroke 不带限位	N/A
	∅7	1:11		

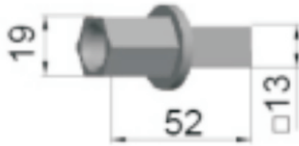

**Innesto esagonale per Argani "SYDNEY"**  
**Sechskantstift für Getriebe "SYDNEY"**  
**Hexagonal pivot for gear winch "SYDNEY" 铝合金适配连接头**

Articolo-Art. No.-编号	Nota-Anm-Remarks 备注
	per 409.101...,409.102...&409.105... für 409.101...,409.102...&409.105... compatible with 409.101...,409.102...&409.105... 与 409.101,409.102&409.105系列配套使用

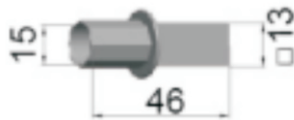

**Innesto esagonale per Argani "SYDNEY"**  
**Sechskantstift für Getriebe "SYDNEY"**  
**Hexagonal pivot for gear winch "SYDNEY" 铝合金适配连接头**

Articolo-Art. No.-编号	Nota-Anm-Remarks 备注
	per 409.103... für 409.103... Compatible with 409.103 与 409.103系列配套使用

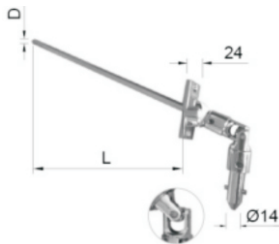

**Snodo 45°**  
**Kreuzgelenk 45°**  
**Cardan Joints 45°**  
**45° 柳接款万向节**

Articolo-Art. No.-编号	L mm	D mm	Materiale-Material Material-连接部件
	250	Ø7	zama-zamak zamac-锌合金
	500	Ø7	
	Customerized		

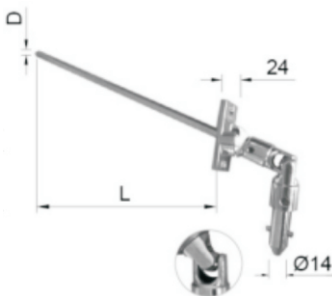

**Snodo 45°**  
**Kreuzgelenk 45°**  
**Cardan Joints 45°**  
**45° 柳接款万向节**

Articolo-Art. No.-编号	L mm	D mm	Materiale-Material Material-连接部件
	250	Ø7	inox-Edelstahl Stainless Steel 不锈钢
	500	Ø7	
	Customerized		



Snodo 45°  
Kreuzgelenk 45°  
Cardan Joints 45°  
45° 柳接款万向节

Articolo-Art. No.-编号	L mm	D mm	Materiale-Material Material-连接部件
	250	Ø 7	zama-zamak zamac-锌合金
	500	Ø 7	
Customerized			



Snodo 45°  
Kreuzgelenk 45°  
Cardan Joints 45°  
45° 柳接款万向节

Articolo-Art. No.-编号	L mm	D mm	Materiale-Material Material-连接部件
	250	Ø 7	inox-Edelstahl Stainless Steel 不锈钢
	500	Ø 7	
Customerized			

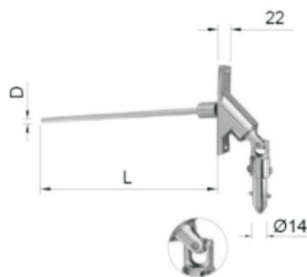

Snodo 90°  
Kreuzgelenk 90°  
Cardan Joints 90°  
90° 柳接款万向节

Articolo-Art. No.-编号	L mm	D mm	Materiale-Material Material-连接部件
	250	Ø 6	zama zamak zamac 锌合金
	500	Ø 6	
	250	Ø 8	
	500	Ø 8	
	250	Ø 7	
	500	Ø 7	
Customerized			

Snodo 90°  
Kreuzgelenk 90°  
Cardan Joints 90°  
90° 铆接款万向节

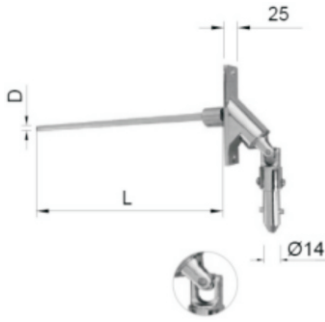

Articolo–Art. No.–编号	L mm	D mm	Materiale–Material Material–连接部件
	250	∅ 6	zama zamak zamac 锌合金
	500	∅ 6	
	250	∅ 8	
	500	∅ 8	
	250	∅ 7	
	500	∅ 7	
	Customerized		

Snodo 90°  
Kreuzgelenk 90°  
Cardan Joints 90°  
90° 铆接款万向节

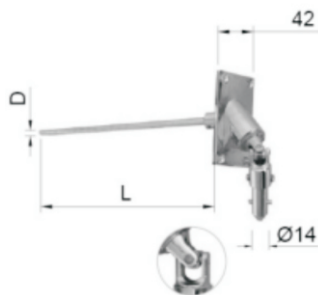

Articolo–Art. No.–编号	L mm	D mm	Materiale–Material Material–连接部件
	250	∅ 6	zama zamak zamac 锌合金
	500	∅ 6	
	250	∅ 8	
	500	∅ 8	
	250	∅ 7	
	500	∅ 7	
	Customerized		

Snodo 90°  
Kreuzgelenk 90°  
Cardan Joints 90° ,welded and polished, 90° 焊接款万向节



Articolo-Art. No.-编号	L mm	D mm	Materiale-Material Material-连接部件
	250	∅ 8	inox Edelstahl Stainless Steel 不锈钢
	500	∅ 8	
	250	∅ 7	
	500	∅ 7	
	Customized		
	250	∅ 8	Ferro Stahl steel 碳钢
	500	∅ 8	
	250	∅ 7	
	500	∅ 7	
	Customized		

Snodo 90°  
Kreuzgelenk 90°  
Cardan Joints 90° ,welded and polished, 90° 焊接款万向节



Articolo-Art. No.-编号	L mm	D mm	Materiale-Material Material-连接部件
	250	∅ 8	inox Edelstahl Stainless Steel 不锈钢
	500	∅ 8	
	250	∅ 7	
	500	∅ 7	
	Customized		
	250	∅ 8	Ferro Stahl steel 碳钢
	500	∅ 8	
	250	∅ 7	
	500	∅ 7	
	Customized		

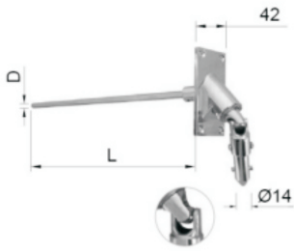

**Snodo 90°**  
**Kreuzgelenk 90°**  
**Cardan Joints 90° ,welded and polished ,90° 焊接款万向节**

Articolo-Art. No.-编号	L mm	D mm	Materiale-Material Material-连接部件
	250	∅ 8	inox Edelstahl Stainless Steel 不锈钢
	500	∅ 8	
	250	∅ 7	
	500	∅ 7	
	Customerized		
	250	∅ 8	Ferro Stahl steel 碳钢
	500	∅ 8	
	250	∅ 7	
	500	∅ 7	
	Customerized		

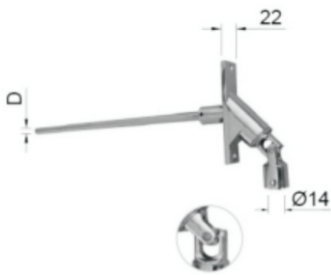

**Snodo 90°**  
**Kreuzgelenk 90°**  
**Cardan Joints 90°**  
**90° 铆接款万向节**

Articolo-Art. No.-编号	L mm	D mm	Materiale-Material 连接部件
	250	∅ 8	zama zamac zamac 锌合金
	500	∅ 8	
	250	∅ 7	
	500	∅ 7	
	Customerized		



Snodo 90°  
Kreuzgelenk 90°  
Cardan Joints 90°  
90° 铆接款万向节



Articolo-Art. No.-编号	L mm	D mm	Materiale-Material 连接部件
	250	∅ 8	zama zamac zamac 锌合金
	500	∅ 8	
	250	∅ 7	
	500	∅ 7	
	Customerized		

Snodo 90°  
Kreuzgelenk 90°  
Cardan Joints 90° ,welded and polished  
90° 焊接款万向节



Articolo-Art. No.-编号	L mm	D mm	Materiale-Material Material-连接部件
	250	∅ 8	inox Edelstahl Stainless Steel 不锈钢
	500	∅ 8	
	250	∅ 7	
	500	∅ 7	
	Customerized		
	250	∅ 8	Ferro Stahl steel 碳钢
	500	∅ 8	
	250	∅ 7	
	500	∅ 7	
	Customerized		

Snodo 90°  
Kreuzgelenk 90°  
Cardan Joints 90°  
90° 铆接款万向节

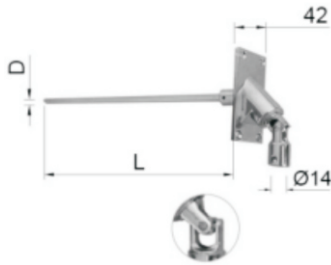

Articolo-Art. No.-编号	L mm	D mm	Materiale-Material 连接部件
	250	∅ 8	zama zamak zamac 锌合金
	500	∅ 8	
	250	∅ 7	
	500	∅ 7	
	Customerized		

Snodo 90°  
Kreuzgelenk 90°  
Cardan Joints 90° ,welded and polished  
90° 焊接款万向节



Articolo-Art. No.-编号	L mm	D mm	Materiale-Material Material-连接部件
	250	∅ 8	inox Edelstahl Stainless Steel 不锈钢
	500	∅ 8	
	250	∅ 7	
	500	∅ 7	
	Customerized		
	250	∅ 8	Ferro Stahl steel 碳钢
	500	∅ 8	
	250	∅ 7	
	500	∅ 7	
	Customerized		



**Snodo 90°**  
Kreuzgelenk 90°  
Cardan Joints 90° ,welded and polished  
90° 焊接款万向节

Articolo-Art. No.-编号	L mm	D mm	Materiale-Material Material-连接部件
	250	∅ 8	inox Edelstahl Stainless Steel 不锈钢
	500	∅ 8	
	250	∅ 7	
	500	∅ 7	
	Customerized		
	250	∅ 8	Ferro Stahl steel 碳钢
	500	∅ 8	
	250	∅ 7	
	500	∅ 7	
	Customerized		

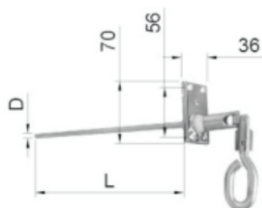

**Snodo50°**  
Kreuzgelenk 50°  
Cardan Joints 50°  
50° 铆接款万向节

Articolo-Art. No.-编号	L mm	D mm	Materiale-Material Material-连接部件
	250	∅ 8	Ferro Stahl steel 碳钢
	500	∅ 8	
	250	∅ 7	
	500	∅ 7	
	Customerized		

Manovella Snodata  
Gelenkurbel  
Articulated Handle  
小摇把

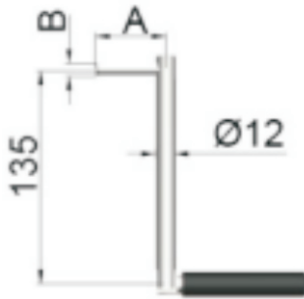

Articolo-Art. No.-编号	A mm	B mm	Materiale-Material Material-主材
	80	∅ 8	Ferro Stahl Steel 碳钢
	50	∅ 8	
	50	∅ 8	
	80	∅ 8	
	80	∅ 7	
	50	∅ 7	
	Customerized		

Manovella Snodata  
Gelenkurbel  
Articulated Handle  
小摇把

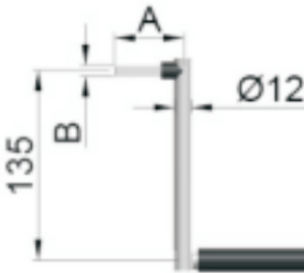

Articolo-Art. No.-编号	A mm	B mm	Materiale-Material Material-主材
	50	∅ 8	Ferro Stahl Steel 碳钢
	50	∅ 7	
	Customerized		

Asta plastificata Ø14  
Plastifizierte kurbelstange Ø14  
Foldable Handcrank Ø14  
可折叠摇杆 Ø14

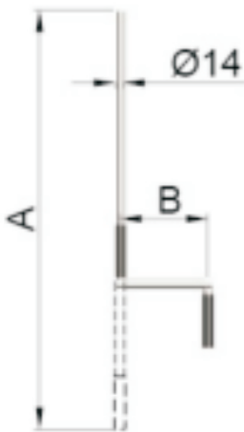

Articolo-Art. No.-编号	A mm	B mm	Materiale-Material Material-主材
	1500	140	Ferro Stahl Steel 碳钢
	1600	140	
	1900	140	
	Customerized		

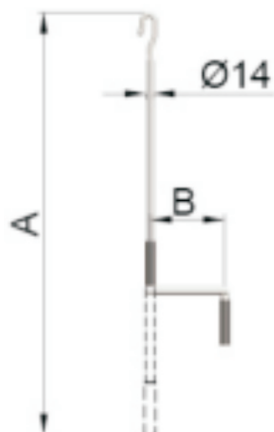

Asta plastificata Ø14  
Plastifizierte kurbelstange Ø14  
Foldable Handcrank Ø14 可折叠摇杆 Ø14

Articolo-Art. No.-编号	A mm	B mm	Materiale-Material Material-主材
	1500	140	Ferro Stahl Steel 碳钢
	1600	140	
	1900	140	
	Customerized		

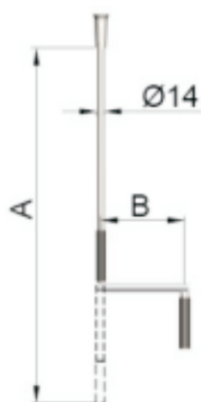

Plastifizierte kurbelstange Ø14 mit bajoneffverschluss  
Foldable Handcrank Ø14, with quick bayonet coupling  
带喇叭件可折叠摇杆 Ø14

Articolo-Art. No.-编号	A mm	B mm	Materiale-Material Material-主材
	1500	140	Ferro Stahl Steel 碳钢
	1600	140	
	1900	140	
	Customerized		

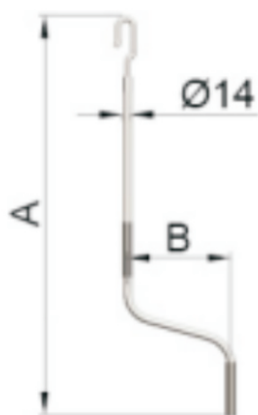

Asta plastificata Ø14, con uncino  
Plastifizierte kurbelstange Ø14 mit der haken  
Unfoldable Handcrank Ø14, with hook  
带钩可折叠摇杆 Ø14

Articolo-Art. No.-编号	A mm	B mm	Materiale-Material Material-主材
	1200	180	Ferro Stahl Steel 碳钢
	1500	180	
	1700	180	
	Customerized		

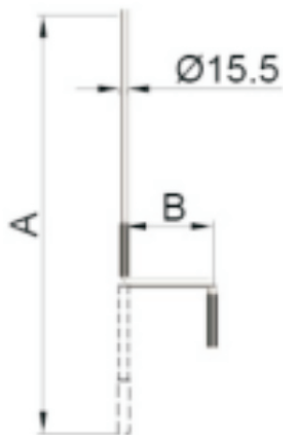

**Asta plastificata Ø14**  
Plastifizierte kurbelstange Ø14  
Foldable Handcrank Ø14  
可折叠摇杆 Ø14

Articolo-Art. No.-编号	A mm	B mm	Materiale-Material Material-主材
	1500	140	Alluminio Aluminium Aluminum 铝合金
	1600	140	
	1900	140	
	Customerized		

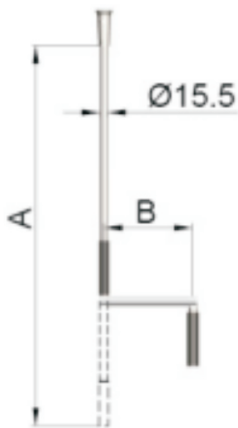

**Asta in Alluminio Ø15.5**  
Aluminium kurbelstange Ø15.5 mit bajoneffverschluss  
Foldable Aluminium Handcrank Ø15.5, with quick bayonet coupling  
带喇叭件可折叠铝合金摇杆摇杆 Ø14

Articolo-Art. No.-编号	A mm	B mm	Materiale-Material Material-主材
	1500	140	Alluminio Aluminium Aluminum 铝合金
	1600	140	
	1900	140	
	Customerized		

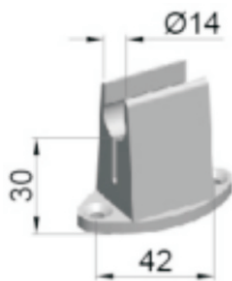

**Fermoasta in Plastica**  
Kurbelfeststeller aus Kunststoff  
Handcrank Bracket 摇杆卡座

Articolo-Art. No.-编号	IL Colore-Farbe-Colour-颜色
	Bianco -Weiss- White-白色 marrone-braun-brown-棕色 Nero-schwarz-black-黑色

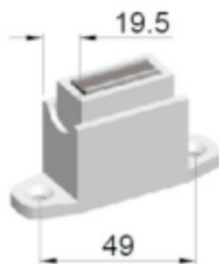

**Fermoasta magnetico**  
Magnet-Kurbelfeststeller  
Magnetic Handcrank Bracket 带磁铁的摇杆卡座

Articolo-Art. No.-编号	IL Colore-Farbe-Colour-颜色
	Bianco -Weiss- White-白色 marrone-braun-brown-棕色 Nero-schwarz-black-黑色



**Manovella Snodata Per asta**  
**Gelenkurbel für kurbelstange**  
**Handle for handcrank 摇杆手柄**

Articolo-Art. No.-编号	IL Colore-Farbe-Colour-颜色
	Bianco -Weiss- White-白色 marrone-braun-brown-棕色 Nero-schwarz-black-黑色



**Manovella Snodata Per asta**  
**Gelenkurbel für kurbelstange**  
**Handle for handcrank 摇杆手柄**

Articolo-Art. No.-编号	IL Colore-Farbe-Colour-颜色
	Bianco -Weiss- White-白色 marrone-braun-brown-棕色 Nero-schwarz-black-黑色

**Molle di sicurezza per stecca"mini"**  
**Scherungsfedern für stäbe"mini"**  
**Security Spring with plaStic prifile 塑料型材不锈钢挂条**

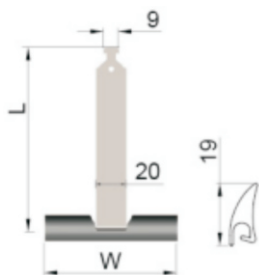

Articolo-Art. No.-编号	W mm	L mm	Surface	la spessore-dicke thickness-厚度
	100	130	un-painted	0.3mm
	100	130	with Felt	0.3mm
	100	170	un-painted	0.3mm
	100	170	with Felt	0.3mm
	100	190	un-painted	0.3mm
	100	190	with Felt	0.3mm
			Customerized	

Molle di sicurezza per stecca "mini"  
Scherungsfedern für stäbe "mini"  
Security Spring with plastic profile 塑料型材不锈钢挂条

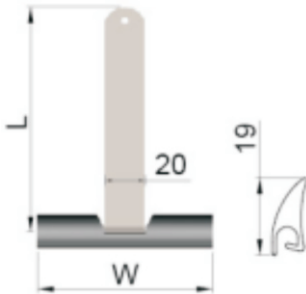

Articolo-Art. No.-编号	W mm	L mm	Surface	la spessore-dicke thickness-厚度
	100	130	un-painted	0.3mm
	100	130	with Felt	0.3mm
	100	170	un-painted	0.3mm
	100	170	with Felt	0.3mm
	100	190	un-painted	0.3mm
	100	190	with Felt	0.3mm
		Customerized		

Molle di sicurezza per stecca "mini"  
Scherungsfedern für stäbe "mini"  
Security Spring with plastic profile 塑料型材不锈钢挂条

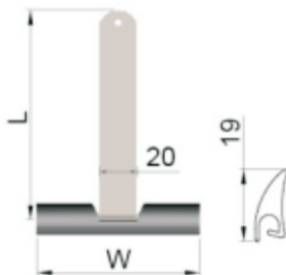

Articolo-Art. No.-编号	W mm	L mm	Surface	la spessore-dicke thickness-厚度
	100	130	un-painted	0.3mm
	100	130	with Felt	0.3mm
	100	170	un-painted	0.3mm
	100	170	with Felt	0.3mm
	100	190	un-painted	0.3mm
	100	190	with Felt	0.3mm
		Customerized		



Molle di sicurezza per stecca"mini"  
Scherungsfedern für stäbe"mini"  
SeCurity Spring with aluMinum profile for Slat"mini"  
铝型材不锈钢挂条

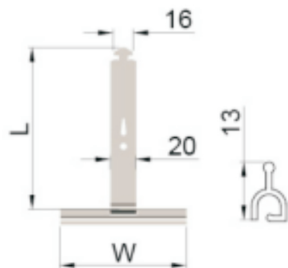

Articolo-Art. No.-编号	W mm	L mm	Surface	la spessore-dicke thickness-厚度
	100	130	un-painted	0.3mm
	100	130	painted	0.3mm
	100	130	painted , with Felt	0.3mm
	100	170	un-painted	0.3mm
	100	170	painted	0.3mm
	100	170	painted , with Felt	0.3mm
	100	190	un-painted	0.3mm
	100	190	painted	0.3mm
	100	190	painted , with Felt	0.3mm
		Customerized		

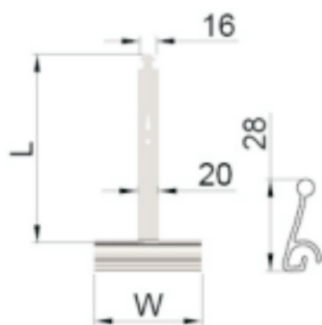

Molle di sicurezza per stecca"mini"  
Scherungsfedern für stäbe"mini"  
SeCurity Spring with aluMinum profile for Slat"mini"  
铝型材不锈钢挂条

Articolo-Art. No.-编号	W mm	L mm	Surface	la spessore-dicke thickness-厚度
	100	170	un-painted	0.3mm
	100	170	painted	0.3mm
	100	170	painted , with Felt	0.3mm
	100	190	un-painted	0.3mm
	100	190	painted	0.3mm
	100	190	painted , with Felt	0.3mm
		Customerized		

Molle di sicurezza per stecca"mini"  
Scherungsfedern für stäbe"mini"  
SeCurity Spring with aluMinum profile for Slat"mini"  
铝型材不锈钢挂条

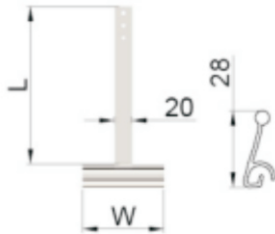

Articolo-Art. No.-编号	W mm	L mm	Surface	la spessore-dicke thickness-厚度
	100	170	un-painted	0.3mm
	100	170	painted	0.3mm
	100	190	un-painted	0.3mm
	100	190	painted	0.3mm
		Customerized		

Molle di sicurezza per stecca"mini"  
Scherungsfedern für stäbe"mini"  
SeCurity Spring with aluMinum profile for Slat"mini"  
铝型材不锈钢挂条

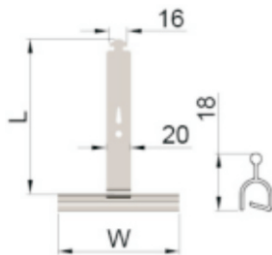

Articolo-Art. No.-编号	W mm	L mm	Surface	la spessore-dicke thickness-厚度
	100	170	un-painted	0.3mm
	100	170	painted	0.3mm
	100	190	un-painted	0.3mm
	100	190	painted	0.3mm
		Customerized		

Molle di sicurezza per stecca"mini"  
Scherungsfedern für stäbe"mini"  
SeCurity Spring with aluMinum profile for Slat"mini"  
铝型材不锈钢挂条

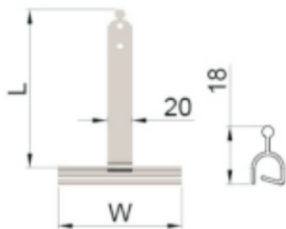

Articolo-Art. No.-编号	W mm	L mm	Surface	la spessore-dicke thickness-厚度
	100	170	un-painted	0.3mm
	100	170	painted	0.3mm
	100	190	un-painted	0.3mm
	100	190	painted	0.3mm
		Customerized		

Molle di sicurezza per stecca"mini"  
Scherungsfedern für stäbe"mini"  
SeCurity Spring with aluMinum profile for Slat"mini"  
铝型材不锈钢挂条

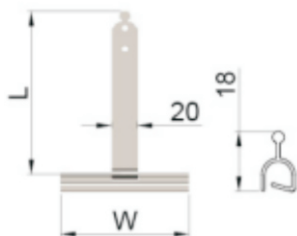

Articolo-Art. No.-编号	W mm	L mm	Surface	la spessore-dicke thickness-厚度
	100mm	170mm	un-painted	0.2mm
	100mm	170mm	with Felt	0.2mm
	100mm	190mm	un-painted	0.2mm
	100mm	190mm	with Felt	0.2mm
			Customerized	

Euroblock Per Stecca"Maxi"  
Euroblock für stäbe"Maxi"  
Euroblock for slat"Maxi" 通用型大帘片防上推

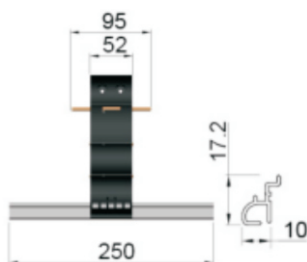

Articolo-Art. No.-编号	Spec. 规格	IL Colore-Farbe Colour-颜色
	2 elementi 2 teile 2 elements 2 连接片	Bianco-Weiss White-白色 Nero-schwarz Black-黑色
	3 elementi 3 teile 3 elements 3 连接片	
	4 elementi 4 teile 4 elements 4 连接片	

Euroblock Per Stecca"Maxi"  
Euroblock für stäbe"Maxi"  
Euroblock for slat"Maxi" 通用型小帘片防上推

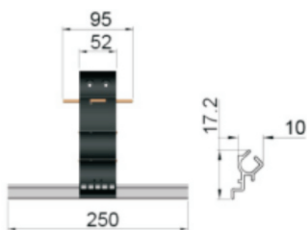

Articolo-Art. No.-编号	Spec. 规格	IL Colore-Farbe Colour-颜色
	2 elementi 2 teile 2 elements 2 连接片	Bianco-Weiss White-白色 Nero-schwarz Black-黑色
	3 elementi 3 teile 3 elements 3 连接片	
	4 elementi 4 teile 4 elements 4 连接片	

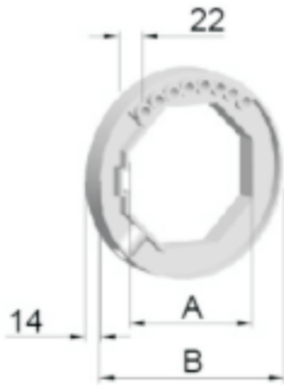

Adattatore per Euroblock  
Adapterring für Euroblock  
Crown for Euroblock  
防上推用固定环

Articolo-Art. No.-编号	A(M)	B(M)
	oct40	6
	oct60	88
	oct70	104

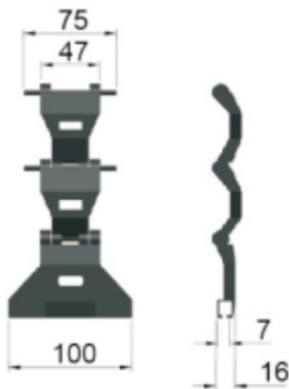

Superblock per Stecca "Maxi"  
Superblock für stäbe: "Maxi"  
Superblock for slat: "Maxi"  
通用型大帘片防上推

Articolo-Art. No.-编号	Spec. 规格	IL Colore-Farbe Colour-颜色
	2 elementi 2 teile 2 elements 2 连接片	Bianco-Weiss White-白色 Nero-schwarz Black-黑色
	3 elementi 3 teile 3 elements 3 连接片	



Adattatore per Superblock  
Adapterring für Superblock  
Crown for Superblock  
防上推用固定环

Articolo-Art. No.-编号	Spec. 规格	IL Colore-Farbe Colour-颜色
	oct60	80
	oct70	90

Molle di compensazione per rullo ottagonode oct 60(con asse □ 13)  
 Hilfsfedern für Achtkantwelle oct 60(Der Schacht □ 13)  
 Universal Assist.Spring for tube oct 60(with shaft □ 13)  
 通用型辅助助力扭簧，适用于60八角管（方轴 □ 13）

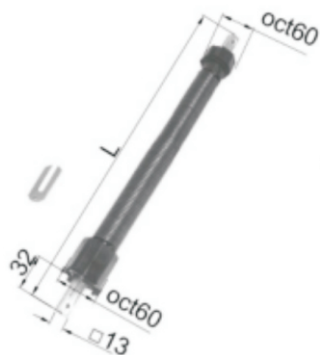

Articolo Artikel Art. No. 编号	Filo drahtwir e 钢丝 φ (mm)	N. Spire Windungen coils 弹簧圈数	L (mm)	Coppia/giro drehm./umdreh. Torque/coil 扭矩/圈 (Kgm)	Forza totale su φ90 Gesamtkraft auf φ90 Total Force on φ90 φ90位置上的总力 (kg)	N. giri Umdreh Turning. 转动圈数
<b>417.235.065</b>	3.5	125	650	0.068	15	10
<b>417.240.086</b>	4.0	160	860	0.090	24	12
<b>417.245.094</b>	4.5	160	940	0.128	34	12
<b>417.245.103</b>	4.5	180	1030	0.114	33	13
<b>417.250.094</b>	5.0	140	940	0.215	62	13
<b>417.255.097</b>	5.5	133	970	0.360	80	10

Molle di compensazione per rullo ottagonode oct 70(con asse □ 13)  
 Hilfsfedern für Achtkantwelle oct 70(Der Schacht □ 13)  
 Universal Assist.Spring for tube oct 70(with shaft □ 13)  
 通用型辅助助力扭簧，适用于70八角管（方轴 □ 13）

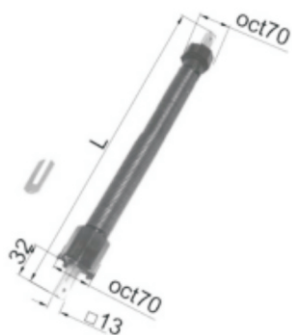

Articolo Artikel Art. No. 编号	Filo drahtwir e 钢丝 φ (mm)	N. Spire Windungen coils 弹簧圈数	L (mm)	Coppia/giro drehm./umdreh. Torque/coil 扭矩/圈 (Kgm)	Forza totale su φ90 Gesamtkraft auf φ90 Total Force on φ90 φ90位置上的总力 (kg)	N. giri Umdreh Turning. 转动圈数
<b>417.340.086</b>	4.0	160	860	0.085	22	13
<b>417.345.103</b>	4.5	180	1030	0.107	30	14
<b>417.350.094</b>	5.0	140	940	0.215	56	13
<b>417.355.127</b>	5.5	188	1270	0.288	75	13
<b>417.360.103</b>	6.0	133	1030	0.500	100	10

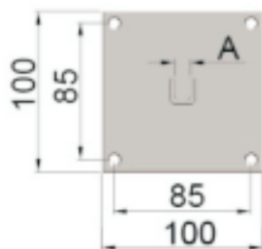

Supporto con tromolla per asse □ 13  
 Hilfsfederlager für Der Schacht □ 13  
 Mounting Bracket for shaft □ 13  
 通用型辅助助力扭簧安装板，与 □ 13 的方轴配套

Articolo-Art. No.-编号	A(M)	Materiale-material-material-材质
	13	Ferro-Stahl- Steel-碳钢



Cintino  
Gurt  
Braided Strap  
织带

Articolo-Art. No.-编号	A(M)	IL Colore-Farbe Colour-颜色
	14	Bianco-Weiss-White-白色 marrone-braun-brown棕色 grigio-grau-grey-灰色
	23	



Kit di riparazione per Cinfino 14mm  
Reparaturset für Gurt "mini"  
Repair Kit for Strap 14mm  
14mm织带修补套件

Articolo-Art. No.-编号	A(M)	IL Colore-Farbe Colour-颜色
	14	Bianco-Weiss-White-白色 marrone-braun-brown棕色 grigio-grau-grey-灰色

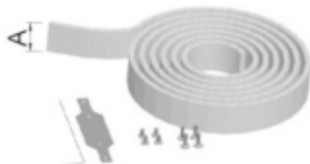

Kit di riparazione per Cinfino 23mm  
Reparaturset für Gurt "maxi"  
Repair Kit for Strap 23mm  
23mm织带修补套件

Articolo-Art. No.-编号	A(M)	IL Colore-Farbe Colour-颜色
	14	Bianco-Weiss-White-白色 marrone-braun-brown棕色 grigio-grau-grey-灰色



Molle di compensazione per rullo ottagonde oct 60(con asse□16)  
Hilfsfedern für Achtkantwelle oct 60(Der Schacht□16)  
Universal Assist.Spring for tube oct 60(with shaft□16)  
通用型辅助助力扭簧, 适用于60八角管 (方轴□16)

Articolo Artikel Art. No. 编号	Filo drahtwir e 钢丝 φ (mm)	N. Spire Windungen coils 弹簧圈数	L (mm)	Coppia/giro drehm./umdreh. Torque/coil 扭矩/圈 (Kgm)	Forza totale su φ 90 Gesamtkraft auf φ 90 Total Force on φ 90 φ 90位置上的总力 (kg)	N. giri Umdreh Turning, 转动圈数
<b>417.435.065</b>	3.5	125	650	0.068	15	10
<b>417.445.094</b>	4.5	160	940	0.128	34	12
<b>417.450.094</b>	5.0	140	940	0.215	62	13
<b>417.455.097</b>	5.5	133	970	0.360	80	10



Molle di compensazione per rullo ottagonde oct 70(con asse□16)  
Hilfsfedern für Achtkantwelle oct 70(Der Schacht□16)  
Universal Assist.Spring for tube oct 70(with shaft□16)  
通用型辅助助力扭簧, 适用于70八角管 (方轴□16)

Articolo Artikel Art. No. 编号	Filo drahtwir e 钢丝 φ (mm)	N. Spire Windungen coils 弹簧圈数	L (mm)	Coppia/giro drehm./umdreh. Torque/coil 扭矩/圈 (Kgm)	Forza totale su φ 90 Gesamtkraft auf φ 90 Total Force on φ 90 φ 90位置上的总力 (kg)	N. giri Umdreh Turning, 转动圈数
<b>417.550.094</b>	5.0	140	940	0.215	56	13
<b>417.555.127</b>	5.5	188	1270	0.288	75	13
<b>417.560.103</b>	6.0	133	1030	0.500	100	10

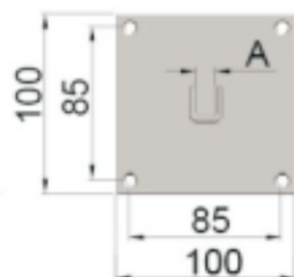

Supporto con tromolla per asse□16  
Hilfsfederlager für Der Schachf□16  
Mounting Bracket for shaft □16  
通用型辅助助力扭簧安装板, 与□16的方轴配套

Articolo–Art. No.–编号	A(M)	Materiale–material–material–材质
	16	Ferro–Stahl– Steel–碳钢



## 中山宜贝节能技术有限公司

Zhongshan Yeaby Energy Saving Technology Co., Ltd.

地址:中山市小榄镇绩东二裕恒南路2号菊城第一工业园

电话:+86-0760-87960687

传真:+86-0760-22231867

邮箱:hqhjob@163.com

一心一意只为优质生活