

NOTE: All copyrights reserved, reprint is allowed.  
All discrepancy of products in the catalogue are subjected to the real product.

威而達 攝影廣告有限公司 攝影/設計/承印 HT1609307 Tel: +86-757-8338096

<sup>TM</sup>  
**DongPin**  
东 品



广东东品美容医疗科技有限公司

GUANGDONG DONGPIN BEAUTY & MEDICAL TECHNOLOGY CO.,LTD

地址: 广东省佛山市南海区九江镇九樵路金福路段2号

Add: Clothing&home textil industry city, Jiuqiao road, Jiujiang Town,  
Nanhai District, Foshan City, Guangdong Province, China

Tel: 0757-81290218 (Chinese) +86-757-86905468 (English)

Fax: 0757-86905448

WeChat: gddongpin

E-mail: sales@dong-pin.com

Website: www.treatmenttablefactory.com

www.dong-pin.com.cn

www.dong-pin.cn

**DongPin**

MEDICAL SERIES  
医疗系列

# DESIGN DETAILS TIME QUALITY

If you want to find a professional partner in China,  
Dongpin would be a

*Good Choice*



Guangdong Dongpin beauty & medical technology Co., Ltd. is a technology company who provides beauty furnitures and physiotherapy furnitures from design to sell.

The company was found in 2002, registering with RMB 10 million, office building (including R&D, Marketing, Sales, QC, Lab et.) is 5,000 square meters large with more than 80 office employees. our factory is 20,000 square meters large with a lot of automation machines, such as fiber laser cutting machine, robot welding, automatic bending machine et., and more than 80% process are finished by automatic machine in our factory for now.

We focus on research and development, our R&D team is more than 20 engineers, they working on how to make product more reasonable, how to produce the products with a standard craft, they are improving the value of our products by technology. and we have more than 100 patents on our products or part for now.

We also have professional QC team with over 10 members to control the quality, we manage strictly from raw materials to every production procedure, we qualified with ISO 13485 certificate as well.



Laser Cutting



Lab



Welding Robot



Office Building



Dongpin



Manage Team

# *professional*

We also have professional QC team with over 10 members to control the quality, we manage strictly from raw materials to every production procedure, we qualified with ISO 13485 certificate as well.

we manage strictly from raw materials to every production procedure, we qualified with ISO 13485 certificate as well.

we manage strictly from raw materials to every production procedure, we qualified with ISO 13485 certificate as well.

*We manage strictly from raw materials to every production procedure, we qualified with ISO 13485 certificate as well.*



# Letter Of Patent (parts)

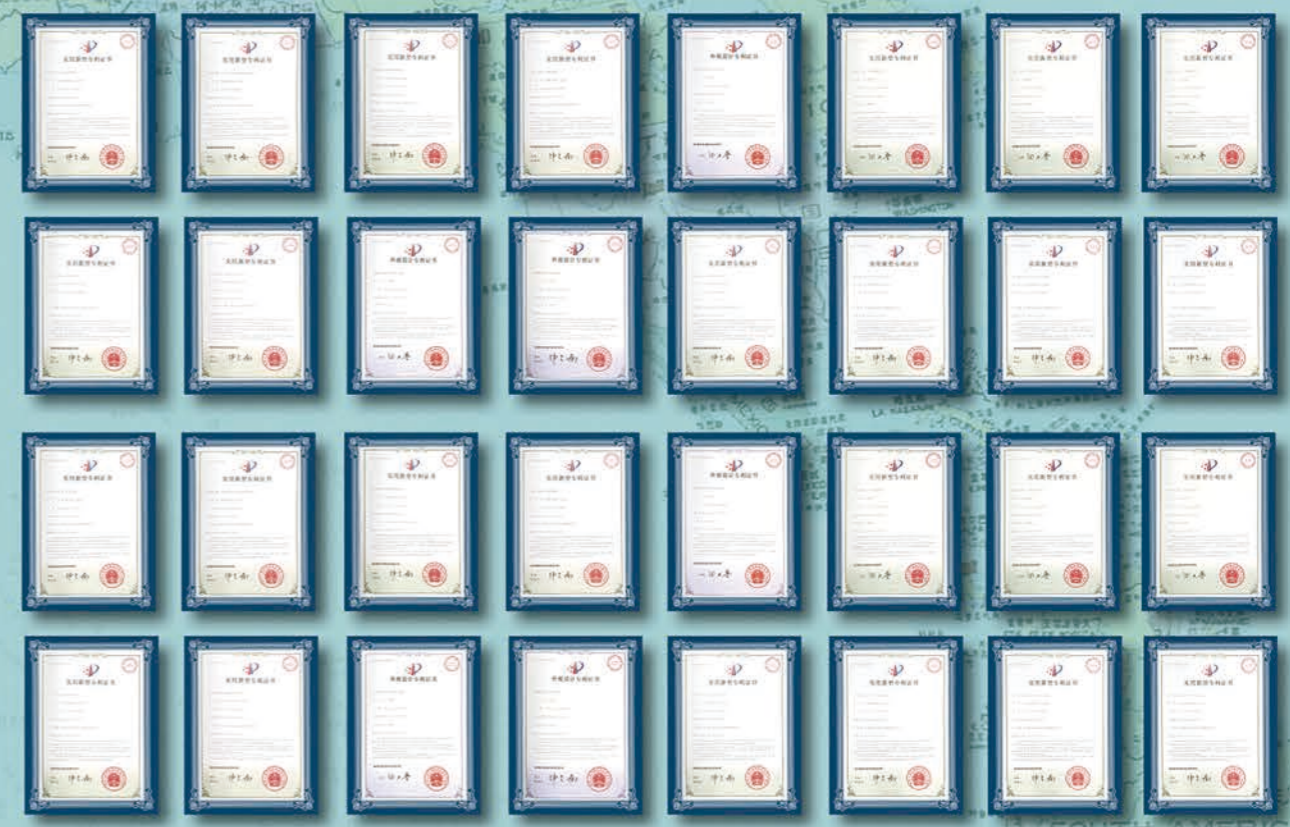

We also have professional QC team with over 10 members to control the quality, we manage strictly from raw materials to every production procedure, we qualified with ISO 13485 certificate as well.

# QUALITY



 **DP-S805A** (two motors)  
Treatment Table



Option 1: Lateral Control

Option 2: Foot Control



# DP-S805A (two motors) Treatment Table

- Packing dimensions: 200\*70\*55 cm
- Length: 197 cm
- Width: 69 cm
- Height: 53/97 cm
- Weight: 83/93 kg
- Max load: 200 kg



## Treatment Table articulations:

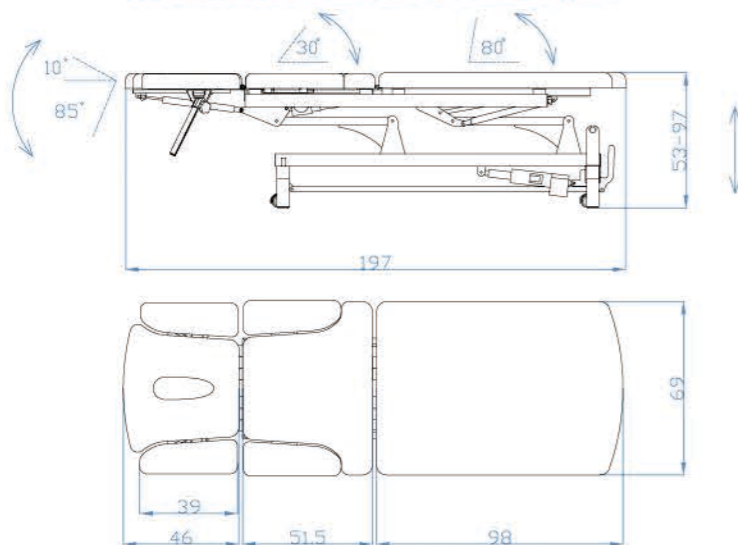

Lateral control



## DP-S8 Series

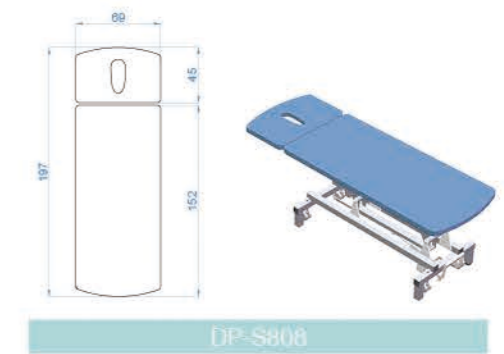
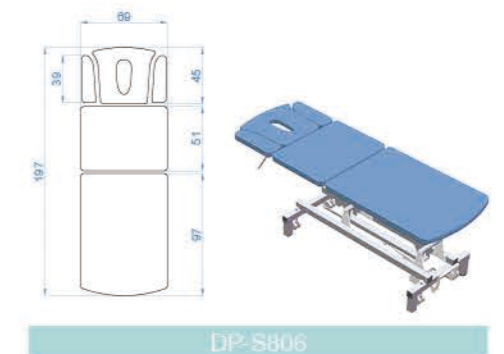
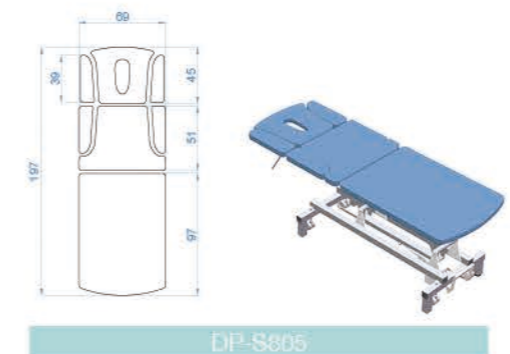
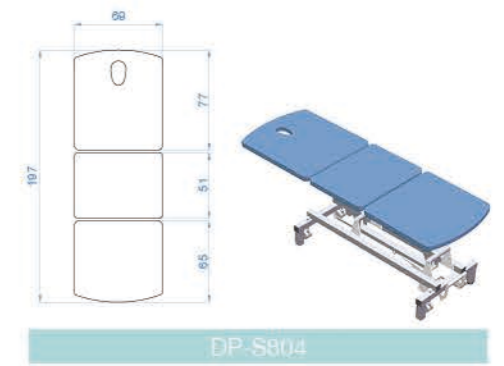
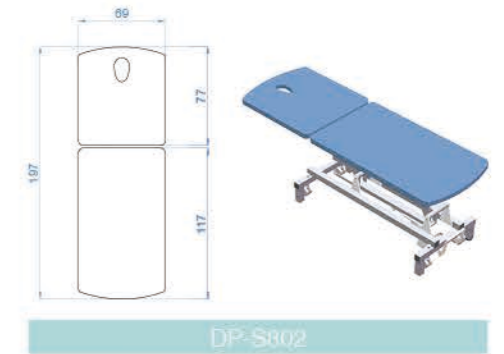
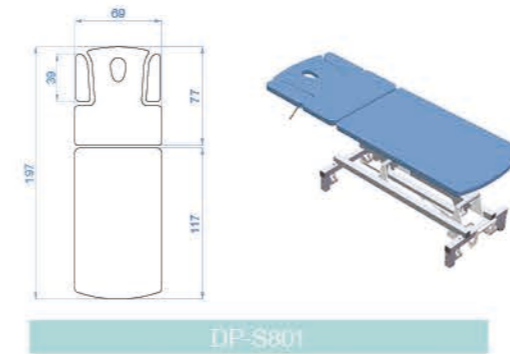
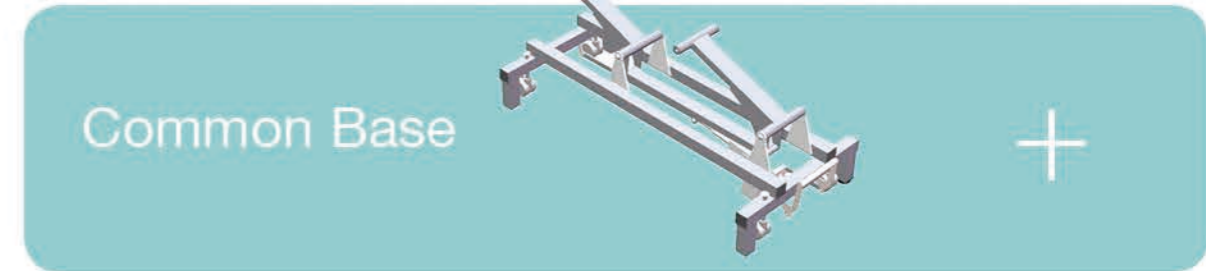

# DP-H508A Hydraulic Treatment Table

- Packing dimensions: 200\*70\*55 cm
- Length: 197 cm
- Width: 69 cm
- Height: 50/96 cm
- Weight: 63/73 kg
- Max load: 200 kg



Option: Paper Roller

## articulations:



Paper roller

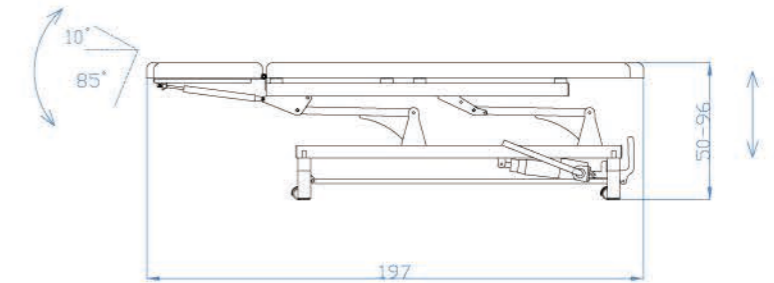

## DP-H5 Series

Common Base

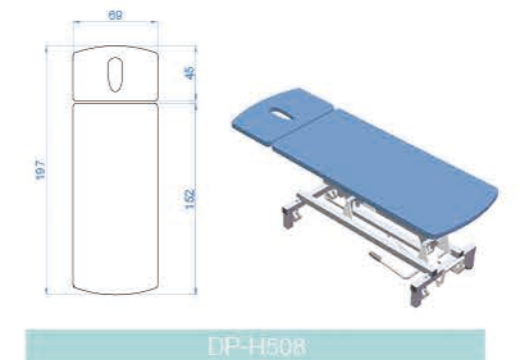
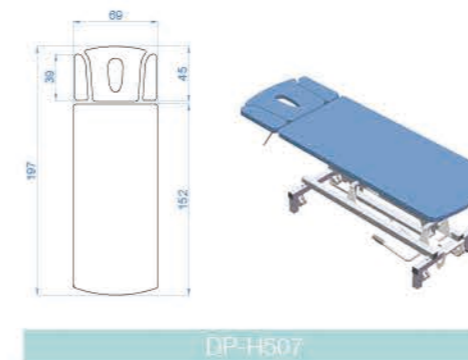
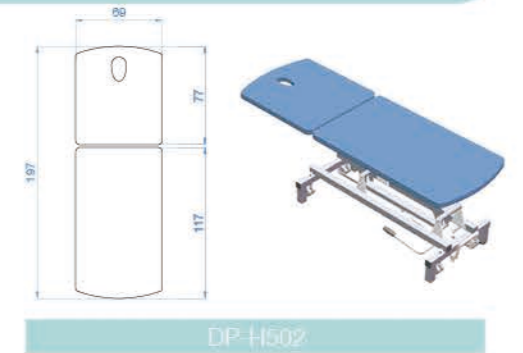
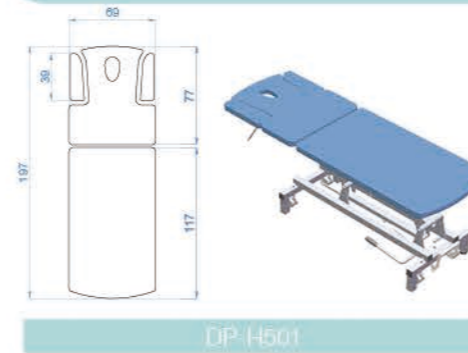
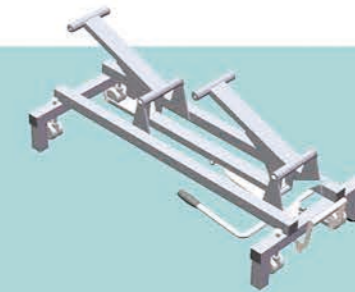

## DP-8430 Gynecological Examination Table

- Packing dimensions: 194\*69\*70 cm
- Length: 190 cm
- Weight: 55/66 kg
- Width: 64/84 cm
- Max load: 100 kg
- Height: 65/90 cm



## DP-8330 Examination Table





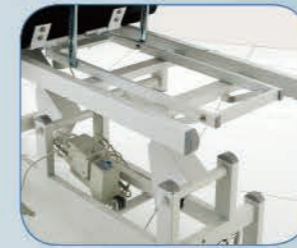

- Packing dimensions: 185\*69\*63 cm
- Length: 180.5 cm
- Weight: 45/55 kg
- Width: 67.5 cm
- Max load: 150 kg
- Height: 57/86 cm







 DP-8273  
Treatment Table

-  Packing dimensions: 187\*71\*65 cm
-  Length: 190 cm
-  Weight: 60/70 kg
-  Width: 68 cm
-  Max load: 150 kg
-  Height: 60/88 cm

## DP-8280 Bobath Table

- Packing dimensions: 202\*101\*60 cm
- Length: 200 cm
- Weight: 90/100 kg
- Width: 99 cm
- Max load: 200 kg
- Height: 60 cm



## DP-P201 Paramount Bed

- Packing dimensions: 75\*69\*67 cm
- Length: 70-185 cm
- Weight: 35/45 kg
- Width: 65 cm
- Max load: 150 kg
- Height: 95-65 cm









# Y9 Medical chair series

## DP-Y931

-  Packing dimensions: 58\*58\*40 cm
-  Length: 60 cm
-  Weight: 9/10 kg
-  Width: 60 cm
-  Max load: 150 kg
-  Height: 50/65 (seat), 87/102 (total) cm









## DP-Y921

-  Packing dimensions: 58\*58\*40 cm
-  Length: 60 cm
-  Width: 60 cm
-  Height: 55/70 (seat), 90/105 (total) cm
-  Weight: 10/11 kg
-  Max load: 150 kg



## DP-Y911

-  Packing dimensions: 58\*58\*40 cm
-  Length: 60 cm
-  Width: 60 cm
-  Height: 53/65 (seat), 83/95 (total) cm
-  Weight: 9/10 kg
-  Max load: 150 kg

## Available style:



## DP-Y912

-  Packing dimensions: 58\*58\*20 cm



## DP-Y913

-  Packing dimensions: 58\*58\*25 cm



## DP-Y914

-  Packing dimensions: 58\*58\*40 cm



## DP-Y922

-  Packing dimensions: 58\*58\*30 cm



## DP-Y923

-  Packing dimensions: 58\*58\*30 cm



## DP-Y924

-  Packing dimensions: 58\*58\*45 cm

**DP-Y941 (YB05)**

- Packing dimensions: 58\*58\*30 cm
- Length: 60 cm
- Width: 60 cm
- Height: 50-63(seat)/82-102(total) cm
- Weight: 10/11 kg
- Max load: 150 kg



**DP-Y921 (YB05)**

- Packing dimensions: 58\*58\*40 cm
- Length: 60 cm
- Width: 60 cm
- Height: 56-71(seat)/91-106(total) cm
- Weight: 10/11 kg
- Max load: 150 kg

**DP-Y916 (YB05)**

- Packing dimensions: 58\*58\*30 cm
- Length: 60 cm
- Width: 60 cm
- Height: 50-63(seat)/82-102(total) cm
- Weight: 10/11 kg
- Max load: 150 kg



**DP-Y921 (YB06)**

- Packing dimensions: 58\*58\*40 cm
- Length: 60 cm
- Width: 60 cm
- Height: 56-71(seat)/91-106(total) cm
- Weight: 10/11 kg
- Max load: 150 kg

**DP-Y941 (YB06)**

- Packing dimensions: 58\*58\*30 cm
- Length: 60 cm
- Width: 60 cm
- Height: 50-63(seat)/82-102(total) cm
- Weight: 10/11 kg
- Max load: 150 kg

**DP-Y915 (YB04)**

- Packing dimensions: 58\*58\*30 cm
- Length: 60 cm
- Width: 60 cm
- Height: 44-57(seat)/68-81(total) cm
- Weight: 10/11 kg
- Max load: 150 kg

Available base:



**YB01**



**YB04**



**YB02**



**YB05**



**YB03**



**YB06**

Optional parts:



**YP01**



**Adjustable Handrest**



**YP02**



**Foot Control System**



**DP-T601**

-  Packing dimensions: 61\*46\*82 cm
-  Length: 55 cm
-  Width: 40 cm
-  Height: 82 cm









**DP-6038**

-  Packing dimensions: 83\*56\*10(1/3) 52\*38\*3(2/3) 59\*46\*16(3/3) cm
-  Length: 58.7 cm
-  Width: 41.4 cm
-  Height: 81 cm
-  Weight: 15/17 kg
-  Max load: 60 kg



**DP-6037**

-  Packing dimensions: 83\*56\*10(1/3) 52\*38\*3(2/3) 59\*46\*16(3/3) cm
-  Length: 58.7 cm
-  Width: 43 cm
-  Height: 81 cm
-  Weight: 15/17 kg
-  Max load: 60 kg



**DP-6039**

-  Packing dimensions: 83\*56\*10(1/3) 52\*38\*3(2/3) 59\*46\*16(3/3) cm
-  Length: 56.7 cm
-  Width: 41.4 cm
-  Height: 86 cm
-  Weight: 15.5 kg
-  Max load: 60 kg

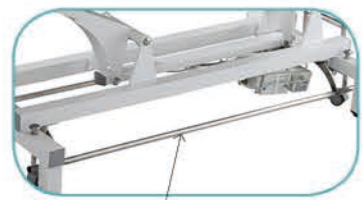

Foot control



Lateral control



Paper roller

Available colors:



YD-P1



YD-P2



YD-P4



YD-P0

Demo Video:



Youtube  
youtu.be/RwixtKeTkP4



优酷

Wood Colour Chart



BLACK

WALNUT

PEAR

CREAM

325H-1

WHITE

365-5

PU colour chart



081

082

091

092

093

094

PVC colour chart



002

150

144

143

012

149

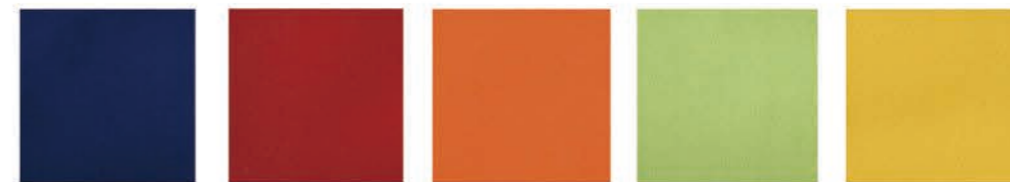

043

014

041

147B

151

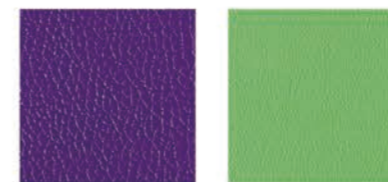

133

135

Available colors



YD-P1

YD-P2

YD-P4

YD-P0

⌵ S Series Available

# CONFIGURATION