

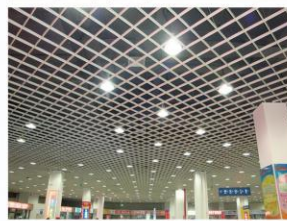

朗仕龙天花与幕墙系统，不断探索精神和艺术理念，探寻建筑装饰与人文艺术的完美融合，满足天花与幕墙的多样化。

我们不仅引进国际一流的生产线，同时在生产中以严谨、细致、精准来要求每一道生产工序，以确保品质的卓越性能，不断追求国际化高品质，整合最新工艺和前沿设计理念，成为天花与幕墙领域里最富有设计美感和艺术内涵的典范。

朗仕龙每件优秀作品，都体现对生活的热爱，实现艺术与产品的完美结合。



目录 CONTENTS

公司简介 ENTERPRISE INTRODUCTION	01
企业证书 QUALIFICATIONGS CERTIFICATE	03
木纹制作流程 WOOD-GRAIN PRODUCTIONS PROCESS	04
钣金生产流程 ALUMINIUM CURTAIN WALL PRODUCTION PROCESS	05
方板天花系列 TILE CEILING SYSTEMS	07
条扣天花系列 LINEAR CEILING SYATEMS	19
格栅天花系列 GRILLE CEILING SYATEMS	27
挂片天花系列 SCREEN CEILING SYATEMS	29
勾搭式天花系列 HOOK-ON TILE CEILING SYATEMS	31
异型天花系列 CUSTOM CEILING SYATEMS	39
工程灯系列 PROJECT LIGHTING SYATEM	45
色卡系列 COLOUR ATLA LIGHTING SYATEM	51
铝蜂窝板 铝屏风 HONEYCOMB PANELS SCREEN SERIES	55
筛网板 瓦楞板 SINVE PLATE CORRUGATED BOARD	59

公司简介 ENTERPRISE INTRODUCTION

上海朗岩建材有限公司是一家专业生产销售室内外金属铝质天花吊顶、金属单层铝幕墙纸、异形天花、铝压纹板、铝蜂窝板、拉伸网、铝网、集成天花吊顶等装饰工程配套材料的大型企业。

公司成立于2008年，经过多年的经营发展，我们已经成立九家分厂，占地面积近30万㎡，与多家知名企业长期合作如：苏宁易购、中设建工、金螳螂等。现我公司引进法国萨麦斯SMAES全自动氟碳喷涂设备和韩国全自动KCI喷粉生产线，电脑数控液压设备，电脑数控转塔冲床、数控剪床、氩弧焊接技术，六条自动喷涂流水线，可满足终端客户不同的数量及要求。

本公司有多名工程设计人员，设计、生产、销售、安装施工一体化，以“质量与世界同步，服务使用户满意”为目标，积极推进ISO9001:2008质量管理体系，从工程设计，产品生产检验，施工安装服务实行严格控制和管理。从售前、售中、售后进行跟踪服务，根据反馈和讯息不断改良，不断开拓创新，开发研制绿色环保的建材产品，本公司采用先进的技术，优质的材料，精湛的工艺，不断为建筑装饰创造高雅、舒适、健康、环保的建筑装饰精品，是国家装饰材料生产基地，推荐优质产品，为多个重点项目指定产品。本公司各大品牌系列天花行销全国各地，出口到东南亚国家，中东、南美、非洲及部分欧洲国家，满足不同工艺标准和要求。

先进的设备，优质的品质，一流的服务，本公司将与你一起走向更辉煌明天。



前台Reception

Shanghai LangYan Building Materials Co., Ltd. is a professional large enterprises in producing and selling indoor and outdoor metal aluminum smallpox ceiling, metal single layer, aluminum curtain wall paper, special-shaped smallpox, aluminum embossing plate, aluminum honeycomb plate, tensile mesh, aluminum mesh, integrated ceiling and other decorative process supporting materials .

We founded in 2008, after years of business development, we have set up nine factories, covers an area of nearly 300,000 square meters,we set up long-term cooperation with a number of well-known enterprises such as: Suning Shopping, Zhongshe construction group , Gold Mantis and so on . Now our company introduced French Samez Smaes fully automatic fluorocarbon spraying equipment and Korea automatic KCI powder spraying production line, computer CNC liquid pressure equipment , computer CNC turret punch, CNC cutting machine, argon arc welding technology . Six automatic spraying line can satisfy different quantity and requirements from the foot terminal customer.



办公室 office Building



优越的办公环境是朗岩人对外形象的一种窗口，它充分展示了金属天花作为新型材料的魅力；同时优越环境是激发员工们工作激情的源动力，体现了“以人为本”的企业文化，加强了员工对企业的认同感和归属感，提升企业在市场上的竞争力！

企业证书 QUALIFICATIONS CERTIFICATE

- 2008年 公司前身：朗岩建材经营部成立；
- 2010年 企业顺利通过了ISO9000质量体系认证；
- 2012年 企业主体更名：上海朗岩建材有限公司成立；
- 2013年 创立“朗仕龙/LSLON”品牌，“朗岩”品牌；
- 2015年 产房搬迁，公司规模进一步扩大
- 2016年 增设木纹转印、铝蜂窝产品系列，进一步实现产品多元化
- 2018年 被阿里巴巴评选为明星商家、实力商家

木纹制作流程 Wood-Grain Production Process

木纹铝板是通过喷涂以及热转印或辊涂的工艺，在铝板表面涂敷木纹装饰涂层。铝板表面的木纹表面具有清晰明了的纤丝细纹或粗扩的仿真木纹纹理，具有色彩丰富、自然逼真的特点。木纹纹理不仅能在平面铝板上应用，更能在异型铝板表面上应用，从而提高了产品外观装饰效果及使用价值，美化了建筑空间环境，为设计师提供了更为广阔的构想空间，以创造出更独特美观的作品。

Wood has inspired art and architecture for thousands of years. One of the most versatile materials available, wood creates a natural and unique atmosphere in both interior and exterior applications. Now we provide the alternative choice to you, it's Wood-Grain ceilings in simulated wood finishes. Wood-Grain ceilings offer the look and feel of wood in a variety of products that minimize limitations. All ceiling systems are available in a wide selection of wood finishes.

OUR CERTIFICATE

KELAIMU(GUANGZHOU) ENERGY EQUIPMENT CO. LTD





条扣生产车间 Linear plank ceiling system



全自动喷涂生产线 Automatic painting production line



自动流水线 Automatic production line



自动成型线 Automatic molding line



天花钣金车间 Metal ceiling workshop



瑞士金马全自动喷涂生产线控制台
Switzerland Gema automatic painting
production line control



瑞士金马全自动喷涂生产线
Switzerland Gema painting production line

钣金生产工艺流程

Aluminium curtain wall production process

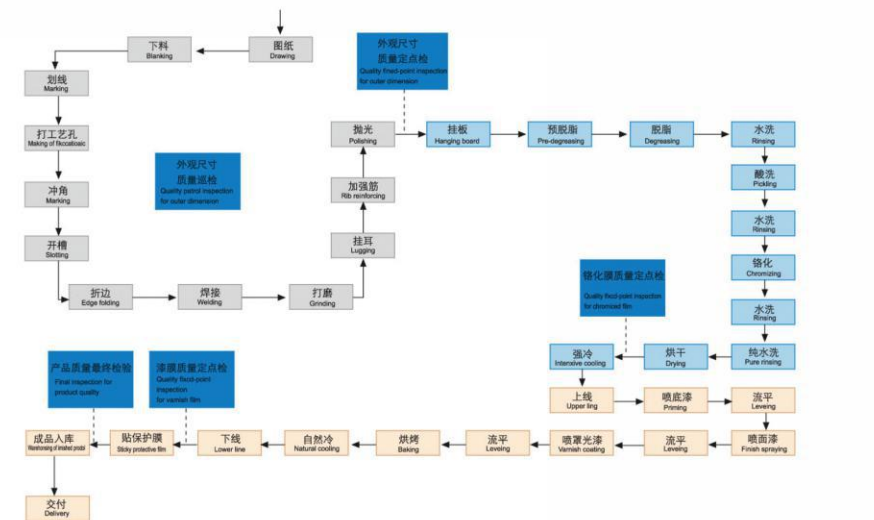

方板天花系列 TILE CEILING SYSTEMS

方形天花的特色与优点：典雅、美观、大方、庄重；结构精巧，装拆简便；无懈可击的防火、防潮功能；拼接无缝，易于清洁，经久耐用；具完善的吸音效果；色彩搭配柔和平顺，单元组装简易，便于维护。

Tile ceiling systems provide a clean, subtle look that communicates a sense of permanence and durability. Our panels contain up to 95% recycled aluminum. Our proprietary manufacturing processes ensures flatness.



方板天花系列(明架) Lay-in Tile Ceiling System

- ▶ 方板天花典雅、明快、大方、结构精巧、品种多样、具有无懈可击的防火、防潮功能，易上清洁、拆装方便、检修线路更方便。
- ▶ 适于高级写字楼、会所、银行、商场等地方使用。多种色彩、规格可供选择。
- ▶ Lay-in tiles are offered in a wide range of sizes, with square, flush or reveal edge details for standard grid options. Lay-in ceilings are a simple, economical way to add a aluminum ceiling to a project.



规格(Size) 单位(Unit): mm

边角	板面 (W、L)	板边 (W、L)	边高 (H)	厚度 (T)
直角 Right-angle	585x585	593x593	8	0.5-1.0
		598x598		
斜角 Beveled	585x585	603x603	10	
		595x595	13	
	575x575	595x595	11	
	595x1195	600x1200		

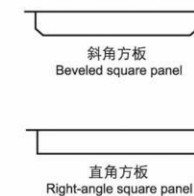
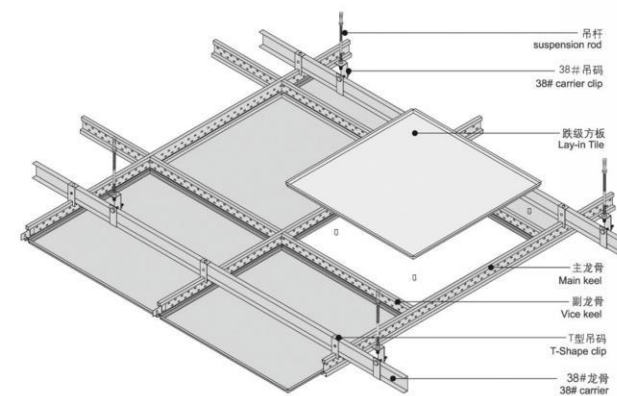

方板明架天花安装示意图
The installation of lay-in tile system

方板天花系列(暗架) Clip-In Tile Ceiling System



暗架方板天花，采用暗架夹入式悬挂系统，方便安装及拆卸，改动室内间隔时倍感灵活。暗架式安装系统结构稳定隐蔽，面板表面平整、线条简洁美观，可为室内空间增添一份现代感。面板拥有不同规格型号，配合不同的设计及需求能广泛应用于多种建筑装饰设计中。

规格(Size) 单位(Unit): mm

规格 (W、L)	厚度 (D)	边高 (H)	备注
300x300	0.45-0.8	20	嵌入式
400x400			
500x500			
300x600	0.6-1.2	可选25或27	组合式
600x600			
300x1200			
500x1200			
600x1200			

The proven durability of Clip-In tile makes them a good selection for aluminum ceiling and wall applications. Our Clip-In system is a familiar, proven solution for the commercial trades.

方板暗架天花安装示意图
The installation of clip-in tile ceiling system

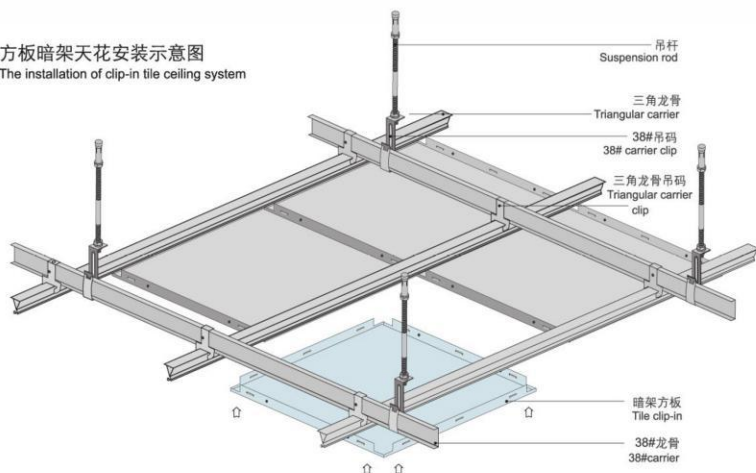

方板小跌级天花系列 Steps Tile Ceiling System



金属跌级天花产品在唯美概念上其组合结构、使用功能、表面颜色、安装效果等各方面都能达到平衡。且易于安装，检修方便，充满时代感的间隔和布局。适应写字楼、宾馆、酒店、车站、机场、商贸娱乐场所、高级住宅等大中小型建筑的装饰。



常用规格(Size):

300x300mm、600x600mm、300x600mm、300x450mm

小跌级方板天花是一种造型独特的方板天花，它是原冲孔方板天花的基础上，增加了一个跌级空间的处理，在视觉上造成丰富的立体感效果，但安装方法仍然与方板天花完全相同。

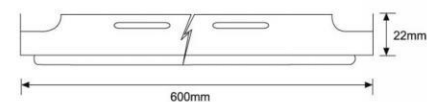

方板小跌级平面局部
The plane of steps tile

三角板专利天花系列 Triangle Patent Ceiling System

- 三角板天花是现代新型创新的设计性天花，设计造型个性，典雅、明快、大方、庄重；结构精巧，装拆简便；无懈可击的防火、防潮功能；拼接无缝，易于清洁，经久耐用；色彩搭配柔和平顺，单元组装简易，便于内层维护。



专利方板天花系列 Clip-in Patent Tile Ceiling System

- 本产品是一种实用新型阶梯形天花扣板，包括有呈常规多边形的正面装饰面以及装饰面周边下方的扣接安装边，装饰面与扣接安装边之间均由阶梯面过渡连接，天花扣板安装拼接进，通过相邻阶梯的拼接形成笔直、美观的凹槽，使天花扣板安装后的棱边轮廓更清晰更明显、立体感更强、视觉效果更佳，本产品具有生产成本低、安装扣接方便、美观耐用等优点，并于2005年3月申请了国家专利。

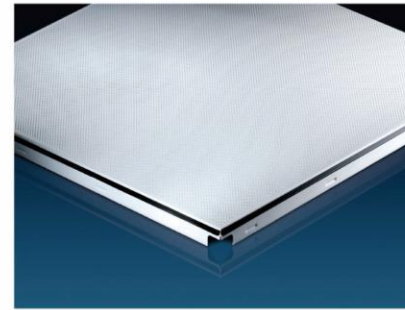

实用新型专利证号：200520056435.4

外观设计专利证号：200530055506.4

■常用规格(Size): 600X600mm 600X1200mm 300X1200mm

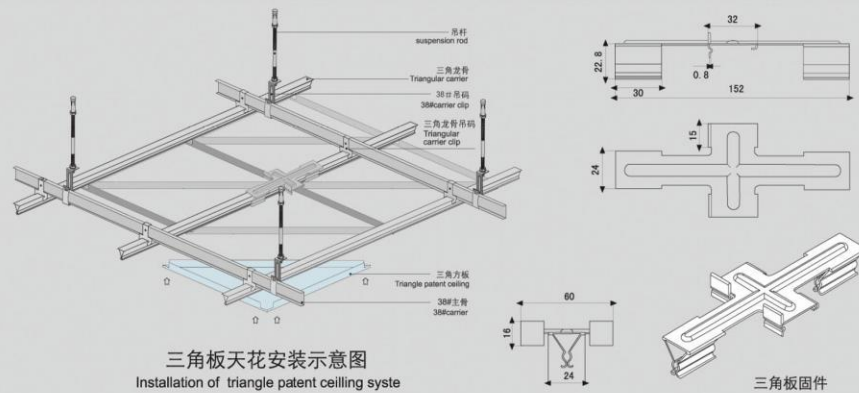

三角板天花安装示意图
Installation of triangle patent ceiling syste

三角板固件

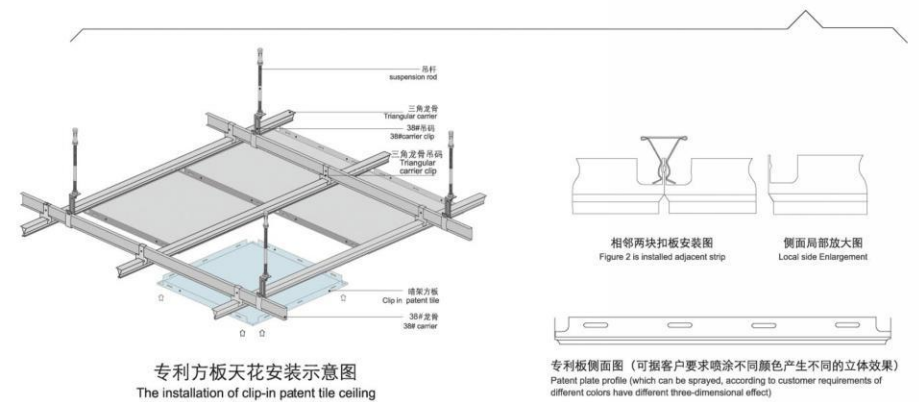

专利方板天花安装示意图
The installation of clip-in patent tile ceiling



相邻两块扣板安装图
Figure 2 is installed adjacent strip



侧面局部放大图
Local side enlargement

专利板侧面图 (可根据客户要求喷涂不同颜色产生不同的立体效果)
Patent plate profile (which can be sprayed, according to customer requirements of different colors have different three-dimensional effect)

普通组合板天花 Combination Ceiling System

■常用规格(Size): 600mmX100mmX600mmX100mm、600mmX150mmX600mmX150mm、
300mmX100mmX300mmX100mm

安装示意图 Installation diagram

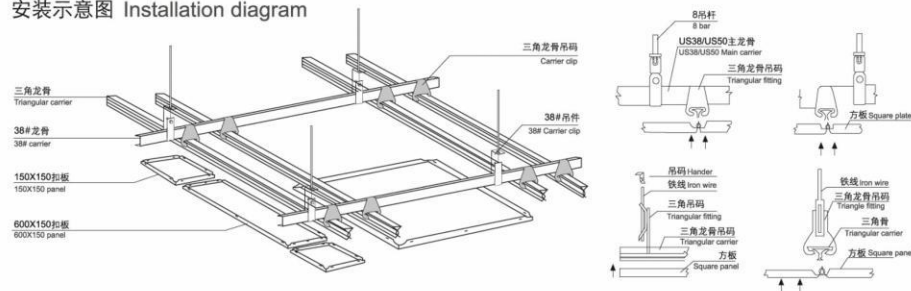

600X600 深井型组合板天花 600x600 Deep frame combining ceiling

板面组合，具有极强的立体效果，充分体现铝吊顶的多变风格，工艺特点。客户可根据各自爱好随意组合，展现不同的风格。一般常用颜色为乳白色，如需其它颜色可参照本公司色卡。组合天花适用于大堂、机场、地铁站、商场等场所。

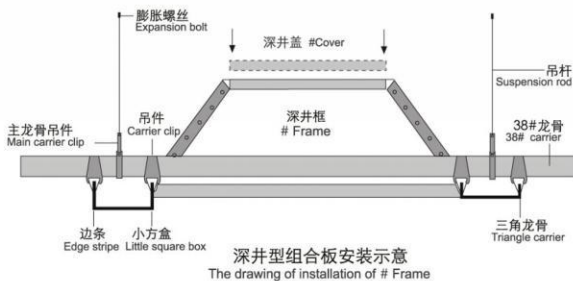

冲孔天花 Perforation Tile



冲孔天花被广泛应用于金属天花板设计，目的是为了减少对外界带来噪音及营造一个舒适的空间。冲孔天花板背面加入隔音纸或隔音棉，有助于增加整个密闭空间的总吸收容量，降低噪音给我们带来的影响。每款冲孔形式均可以提供不同的吸声开放面积比率（冲孔率），达到不同程度的密闭空间吸音需求。尚有多种冲孔形式未能尽录，不同形式的冲孔款式均可以供客户选择。

Sound-absorbing fabric is divided into 冲孔贴布分为

黑吸音布: 13%, 降噪效果
防火性能: 达到国家GB8624-难燃B1级

Black fabric:
13%, Noise reduction effect
Fire safety:
Meet national GB8624-retardant B1 level.

白吸音布: 11%, 降噪消音效果
防火性能: 达到国家GB8624-难燃B1级

White fabric:
11%, Effect noise reduction
Fire safety:
Meet national GB8624-retardant B1 level.

防火吸声纸: 19%, 降噪消音效果
防火性能: 达到国家GB8624-难燃B1级

Fire resistance sound-absorbing fabric:
19%, Noise reduction effect
Fire safety:
Meet national GB8624-retardant B1 level.

进口吸音布: 22%, 降噪消音效果
防火性能: 达到国家GB8624-难燃B1级

Import sound-absorbing fabric:
22%, Noise reduction effect
Fire safety:
Meet national GB8624-retardant B1 level.



600x600方板冲孔天花
600x600
Perforation Tiles



JMS-87 云板 600x600mm



JMS-84 云板 600x600mm

600x600方板冲孔天花
600x600
Perforation Tiles

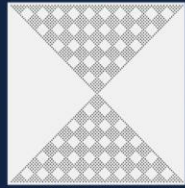

JMS-01 ϕ 3孔对角拼花
 JMS-01 ϕ 3 Diagonal match

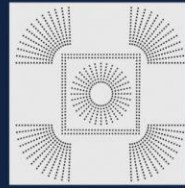

JMS-02 ϕ 3孔拼花
 JMS-02 ϕ 3 Punching match

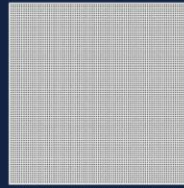

JMS-03 ϕ 1.8孔
 JMS-03 ϕ 1.8 Punching

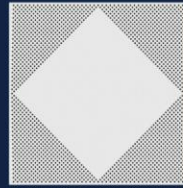

JMS-04 ϕ 3孔拼花
 JMS-04 ϕ 3 Punching match



JMS-17 ϕ 3孔拼花
 JMS-17 ϕ 3 match punching

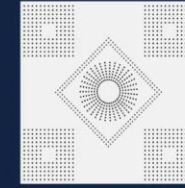

JMS-18 ϕ 3孔正方太阳花
 JMS-18 ϕ 3 square sunflower

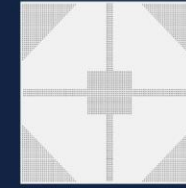

JMS-19 ϕ 3孔拼花
 JMS-19 ϕ 3 match punching



JMS-20 圆井型
 JMS-20 round aluminum plate

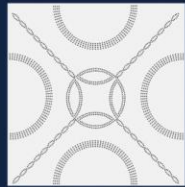

JMS-05 ϕ 2.5孔拼花
 JMS-05 ϕ 2.5 punching match

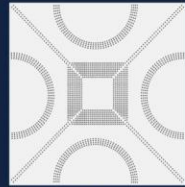

JMS-06 ϕ 2.5孔拼花
 JMS-06 ϕ 2.5 punching match

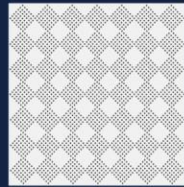

JMS-07 ϕ 3孔49格
 JMS-07 ϕ 3 49-grid match punching



JMS-08 方井型
 JMS-08 #-shaped aluminum plate

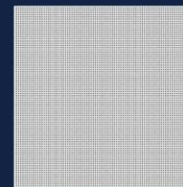

JMS-21 ϕ 2.3孔直排
 JMS-21 ϕ 2.3 straight pile

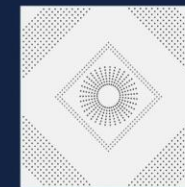

JMS-22 ϕ 3孔太阳花
 JMS-22 ϕ 3 sunflower



JMS-23 ϕ 1.8孔正方对角
 JMS-23 ϕ 1.8 punching diagonal

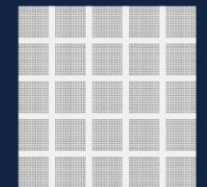

JMS-24 ϕ 1.8孔25格
 JMS-24 ϕ 1.8 25-grid punching

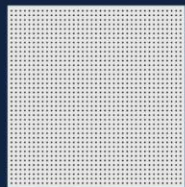

JMS-09 ϕ 6全孔
 JMS-09 ϕ 6 punching



JMS-10 ϕ 3孔25格
 JMS-10 ϕ 3 25-grid



JMS-11 ϕ 3孔对角
 JMS-11 ϕ 3 diagonal match



JMS-12 ϕ 4孔拼花
 JMS-12 ϕ 4 match punching



JMS-25 ϕ 2.5孔拼花
 JMS-25 ϕ 2.5 match punching



JMS-26 ϕ 3全孔
 JMS-26 ϕ 3 punching



JMS-27 平板
 JMS-27 flat plate



JMS-28 ϕ 3孔拼花
 JMS-28 ϕ 3 match punching

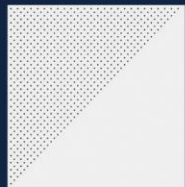

JMS-13 ϕ 3孔大对角
 JMS-13 ϕ 3big diagonal



JMS-14 ϕ 3孔拼花
 JMS-14 ϕ 3 match punching

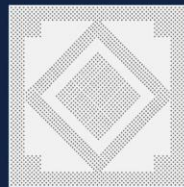

JMS-15 ϕ 3孔拼花
 JMS-15 ϕ 3 match punching



JMS-16 ϕ 3孔拼花
 JMS-16 ϕ 3 match punching

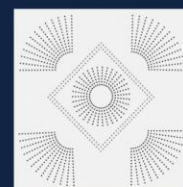

JMS-29 ϕ 3孔太阳花
 JMS-29 ϕ 3 sunflower



JMS-30 ϕ 3孔拼花
 JMS-30 ϕ 3 match punching

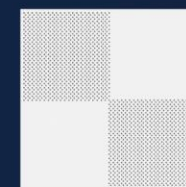

JMS-32 ϕ 3孔正方对角
 JMS-32 ϕ 3 square-diagonal

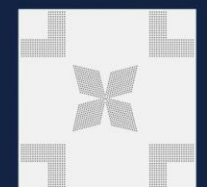

JMS-33 ϕ 2.5孔拼花
 JMS-33 ϕ 2.5 match punching

600x600方板冲孔天花

600x600 Perforation Tiles

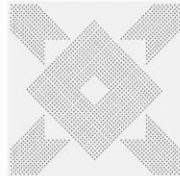

JMS-50 孔拼花跌级 (明架)
JMS-50 $\phi 3$ match punching lay in

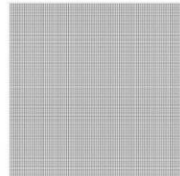

JMS-51 $\phi 1.8$ 孔跌级 (明架)
JMS-51 $\phi 1.8$ all-punching lay in



JMS-102 凸棱形

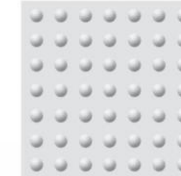

JMS-101 凸圆点
300x300mm 600x600mm

300x300方板冲孔天花

300x300 Perforation Tiles

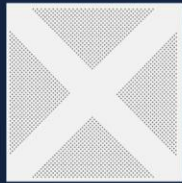

JMS-34 $\phi 3$ 孔拼花
JMS-34 $\phi 3$ match punching

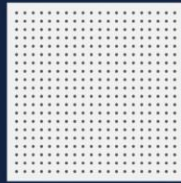

JMS-35 $\phi 10$ 全孔
JMS-35 $\phi 10$ punching

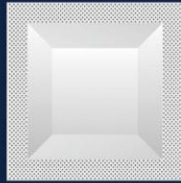

JMS-36 方井四边冲孔
JMS-36 square well punching

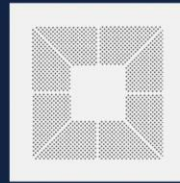

JMS-37 $\phi 3$ 孔拼花
JMS-37 $\phi 3$ match punching



JMS-38 $\phi 3$ 孔拼花
JMS-38 $\phi 3$ match punching

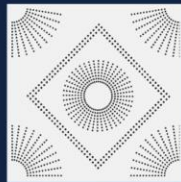

JMS-39 $\phi 3$ 孔拼花
JMS-39 $\phi 3$ match punching



JMS-40 方井型中间孔 $\phi 3$ 孔
JMS-40 $\phi 3$ square-well punching

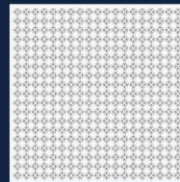

JMS-41 小梅花
JMS-41 small clove leaf punching

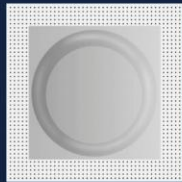

JMS-42 圆井四边冲 $\phi 3$ 孔
JMS-42 $\phi 3$ circular-well punching

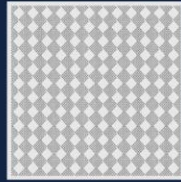

JMS-43 $\phi 1.8$ 孔拼花18格
JMS-43 $\phi 1.8$ -grid match punching

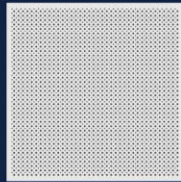

JMS-44 满天星
JMS-44 full-punching

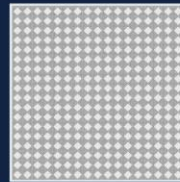

JMS-45 $\phi 1.8$ 孔中方格
JMS-45 $\phi 1.8$ medium-square grid

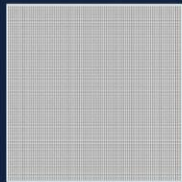

JMS-46 小圆点
JMS-46 full-punching



JMS-47 平板跌级 (明架)
JMS-47 flat plate lay in

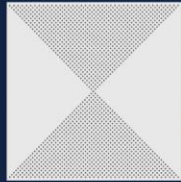

JMS-48 $\phi 3$ 孔对角跌级 (明架)
JMS-48 $\phi 3$ diagonal lay in

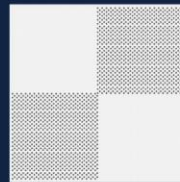

JMS-49 $\phi 3$ 孔正对角跌级 (明架)
JMS-49 $\phi 3$ square diagonal lay in



JMS-84B 云板
300x300mm



JMS-52 孔拼花
300x300mm



JMS-53 风车叶
300x300mm



JMS-54 $\phi 3$ 全孔
300x300mm

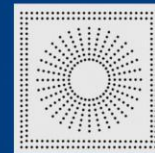

JMS-55 太阳花
300x300mm



JMS-56 中方格
300x300mm

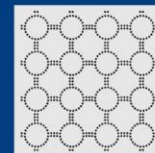

JMS-57 $\phi 1.8$ 孔拼花18格
300x300mm

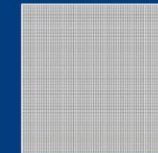

JMS-58 小圆点
300x300mm

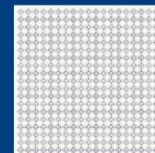

JMS-59 小梅花
300x300mm



JMS-60 方井型
300x300mm



JMS-61 平板
300x300mm

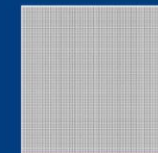

JMS-62 $\phi 1.8$ 孔
300x300mm



JMS-63 $\phi 3$ 孔对角
300x300mm



JMS-65 (300x600) $\phi 1.8$ 孔



JMS-64 (300x600) 平板

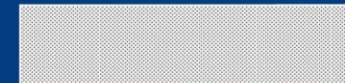

JMS-88 (300x1200) $\phi 1.8$ 孔



JMS-86 (600x1200) 平板

条扣天花系列 LINEAR CEILING SYSTEMS

条扣天花系列采用铝合金板加工而成，板面及线条的整体连贯性强，给人一种舒畅、明快感觉，更可按照设计心思，随心所欲地安排不同宽度、弧度的板条混合安装，使得设计变化万千、功能尽现、效果美观。

Linear Ceilings create a distinct, smooth look. We offer a selection of cost-effective options for all interior and exterior applications. Perforated options provide exceptional acoustical performance, lengths up to 6 meters, and two distinct joint details.

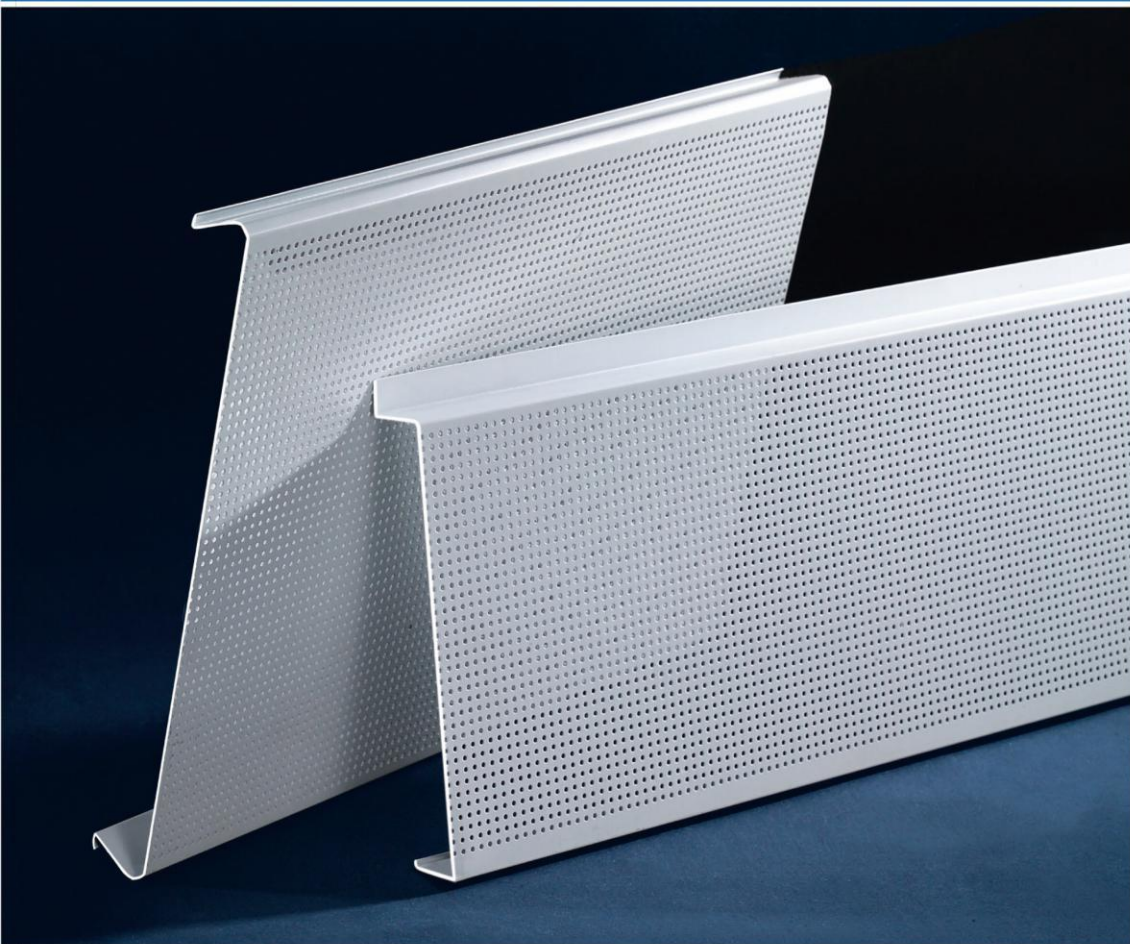

C型密闭式条扣天花系列 C-Shaped Closed Linear Ceiling System

- 有着非常优异的视觉空间延伸性，安装简易灵活，配合格栅天花组合设计安装，视觉效果更加丰富，立体效果更加突出，广泛应用于机场候机大楼、地铁站、银行、展览中心、写字楼、大型会议中心公共空间，C型有平板和冲孔板，最长可以生产6米，并可以定尺寸加工，铝板采用1001H、3003H24国际标准。50、75、100、150、200、300mm宽的C型条扣天花板可以随意拼装，没有缝隙，所有铝板紧密连接。铝板固定在龙骨扣齿上并可以单独拆卸。

- 常用规格(Size):

斜角(Beveled)W: 75mm、100mm、150mm、200mm、300mm

直角(Right-angle)W: 50mm、100mm、150mm、200mm、300mm

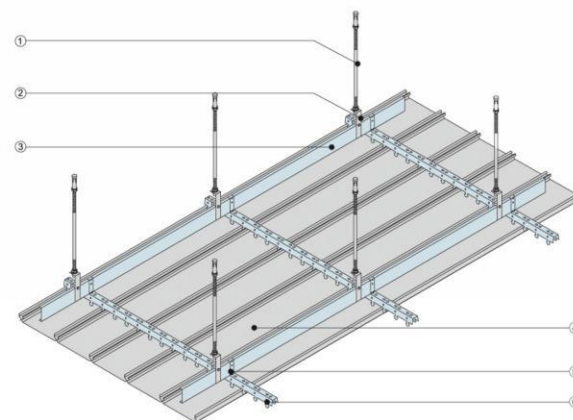
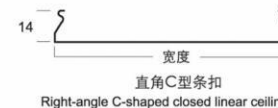

C型密闭式条扣天花安装示意图
The installation of C-shaped closed linear ceiling

- ①吊杆
- ②38#吊码
- ③38#龙骨
- ④C型平面条扣板
- ⑤C型条扣龙骨吊件
- ⑥C型条扣龙骨
- ①Suspension rod
- ②38# carrier clip
- ③38# carrier
- ④C-shaped clip panel
- ⑤C-shaped clip carrier
- ⑥C-shaped clip carrier



C型防风条扣天花系列

C-Shaped Wind -Resistant Linear Ceiling System



- 高身防风条扣结构新颖，设计大方、整体洁净，能完美地表达设计师的意念，且其新颖别致，充满时代感的构架布置。其特点纵向拼接且板面平直，结构稳固线条简洁明快，更富有变化，可生产各种覆膜，喷涂，冲孔等产品系列，适合室内室外安装。

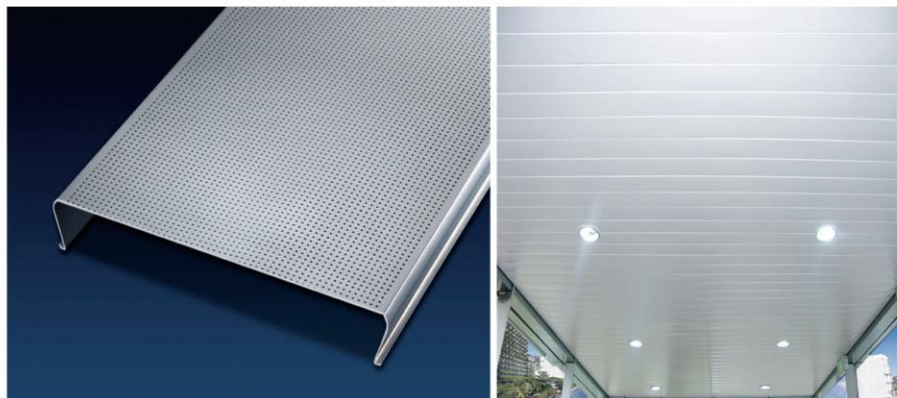

- 常用规格(Size):

300、400、500mm; 400、500mm 厚度(Thickness): 1.1mm-1.5mm

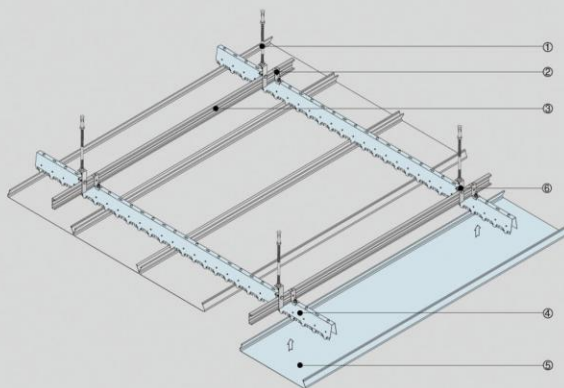

安装示意图
Installation diagram

- | | |
|---------|---------------------------------------|
| ①吊杆 | ①suspension rod |
| ②防风龙骨吊码 | ②C-shaped wind-resistant carrier clip |
| ③38#龙骨 | ③38# carrier |
| ④防风条扣龙骨 | ④C-shaped wind-resistant carrier |
| ⑤C型防风条扣 | ⑤C-shaped wind-resistant panel |
| ⑥38#吊码 | ⑥38# carrier clip |

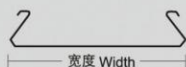

防风条扣(长度可定做, 最长达6000mm)
Wind-resistant linear(the length can be customized, up to 6000mm)

H 型密闭式条扣天花系列

H-Shaped Closed Linear Ceiling System



- H型密闭条扣是由优质铝带通过设备加工而成，直角结构，有200、300、400mm宽，平板或冲孔均可加工，常用长度3米，最长可生产6米，也可定尺寸加工。

同一龙骨可装拼不同规格的板条，结构紧密牢固，板块之间线条连贯，较C扣严密，给人以舒畅、明净、典雅的感觉，更可按照设计者的心思以不同颜色或宽度的板条搭配混合安装使用，使得设计上有更多的变化，以达到更完美的效果，本产品适用于机场、车站、地铁、体育馆、会堂、商场及住宅等场所。

- 常用规格(Size):

矮身密缝(Low H-shaped closed)W: 200mm

高身密缝(High H-shaped closed)W: 200mm、300mm、400mm、500mm

- 安装示意图
Installation diagram

- | | |
|----------|------------------------|
| ①吊杆 | ①Suspension rod |
| ②38#吊件 | ②38# carrier clip |
| ③38#主龙骨 | ③38# carrier |
| ④H型平面条扣板 | ④H-shaped panel |
| ⑤H型龙骨吊件 | ⑤H-shaped carrier clip |
| ⑥H型龙骨 | ⑥H-shaped carrier |

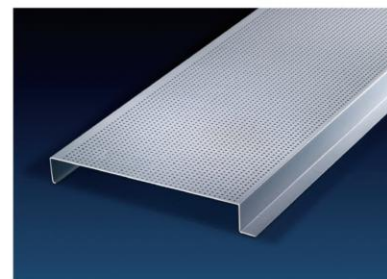
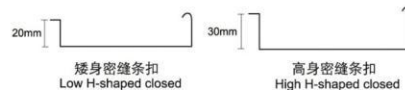
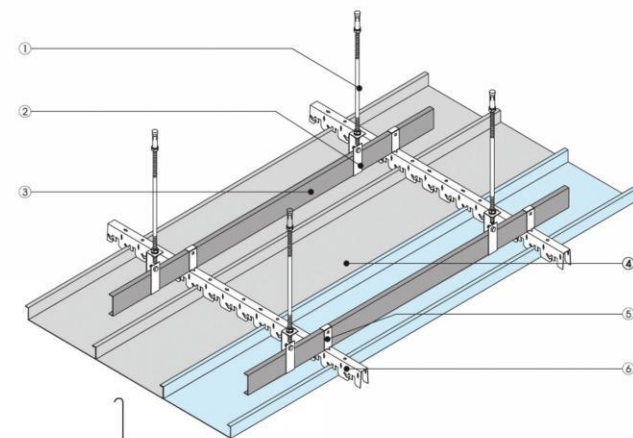

85U型条扣天花系列

85U-Shaped Open Linear Ceiling System

它是条扣天花的又一个新组合，为现代建筑增添新的特色。本产品是由100配小条和85配小条两种组成，更具层次感、时尚感，表面采用纯聚酯喷涂，有十年以上的品质保证，具有抗腐蚀、防火、防潮、易清洗等特点，为游泳馆、办公室、商场等场所的理想装饰材料，更是卧室、卫生间、阳台装饰的首选材料。

常用规格(Size): 85配20小条



图为开口装法
Chart shows open installation



图为闭口装法
Chart shows close installation

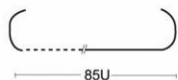

U型条扣剖面
85U-shaped



20mm小条扣
20mm small panel



安装示意图 Installation diagram

- ①吊杆
- ②38#吊件
- ③38#龙骨
- ④85U型龙骨
- ⑤85U型龙骨吊件
- ⑥85U型平面条扣板
- ①Suspension rod
- ②38# Carrier clip
- ③38# Main carrier
- ④85U-shaped carrier
- ⑤85U-shaped carrier clip
- ⑥85U-shaped panel

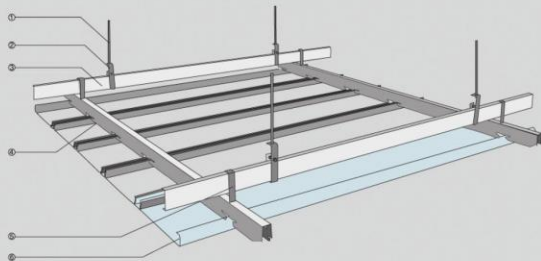

135U配小条条扣天花系列

135U-Shaped Open Linear Ceiling System

时尚最新的直角组合条扣，设计独特创新，结构简洁明快，不同颜色的组合能根据不同的环境要求组合出不同的风格，表现出丰富的空间层次感和立体感。产品由135mm扣板和15mm嵌边条组成，广泛应用于机场、油站、商场、写字楼等公共场所，亦更深受家居装饰的喜爱。

常用规格(Size): 135配15小条



图为开口装法
Chart shows open installation



图为闭口装法
Chart shows close installation



135U型条扣剖面
135-shaped



15mm小条扣
15mm small panel

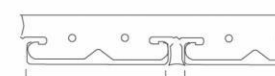

135mm扣板 15mm小条扣
135mm panel 15mm small panel

安装示意图 Installation diagram

- ①吊杆
- ②38#吊件
- ③38#主龙骨
- ④135U型龙骨
- ⑤135U型龙骨吊件
- ⑥135U型平面条扣板
- ①Suspension rod
- ②38# Carrier clip
- ③38# Main carrier
- ④135U-shaped carrier
- ⑤135U-shaped carrier clip
- ⑥135U-shaped panel

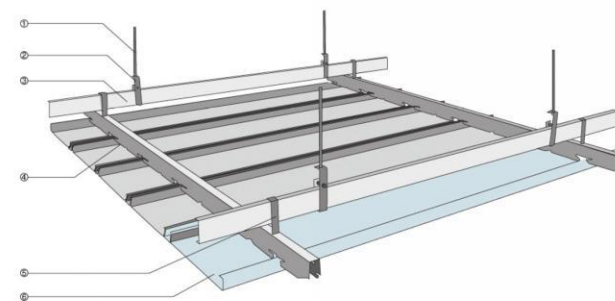

G型有缝式条扣天花系列

G-Shaped Linear Ceiling System

G型有缝式条扣板采用铝合金平板或冲孔板经静电粉末喷涂而成，具有防火、防潮、吸音功能、板面及线条的整体及连贯性强，给人一种舒适畅快之感受。广泛用于机场、大厅、车站及走廊通道等方面。

常用规格(Size): W 100、200、300、400mm

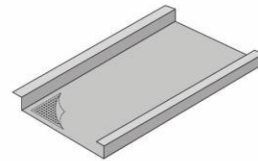

G-shaped perforated panel
G型冲孔条扣

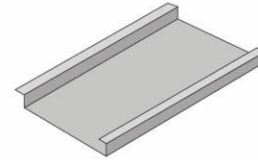

G-shaped flat panel
G型平面条扣

安装示意图

Installation diagram

- ①吊杆
- ②38#吊件
- ③38#龙骨
- ④G型平面条扣
- ⑤G型条扣龙骨吊件
- ⑥G型条扣龙骨

- ①Suspension rod
- ②38# carrier clip
- ③38# Main carrier
- ④G-shaped panel
- ⑤G-shaped carrier clip
- ⑥G-shaped carrier

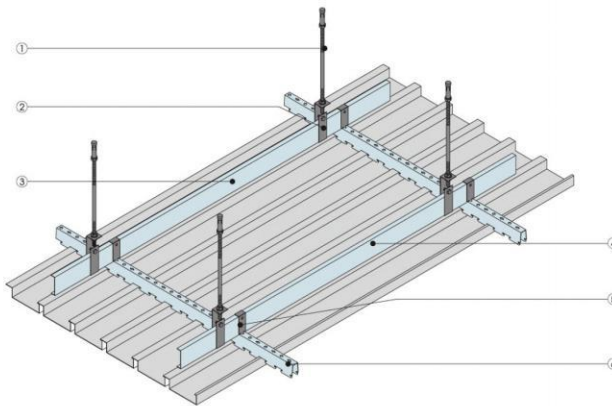

V型条扣天花系列

V-Shaped Linear Ceiling System

V型扣板系列均采用铝合金制成，其龙骨、吊件为镀锌或烤漆钢板，边角为铝合金。表面有多种颜色供选择，有哑光、拉丝、镜面漆等。具有防火功能、可适用于高温环境，在天花上部放置隔音棉可获得良好的吸音效果，而且能满足任何通风要求。

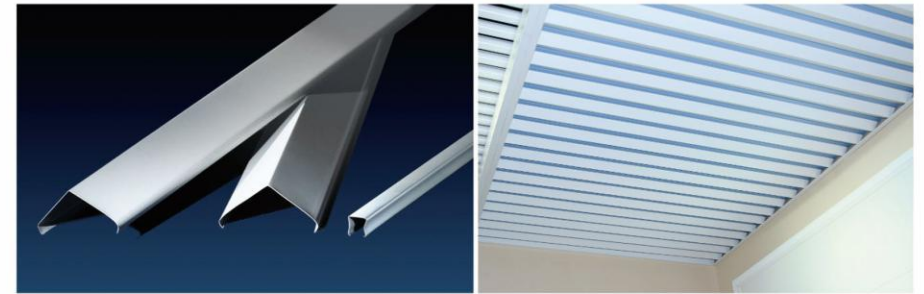

常用规格(Size): V型配小条



安装示意图

Installation diagram

- ①吊杆
- ②38#吊件
- ③38#龙骨
- ④V型龙骨
- ⑤V型龙骨吊件
- ⑥V型平面条扣板

- ①Suspension rod
- ②38# carrier clip
- ③38# carrier
- ④V-shaped carrier
- ⑤V-shaped carrier clip
- ⑥V-shaped panel

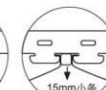
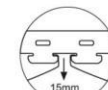
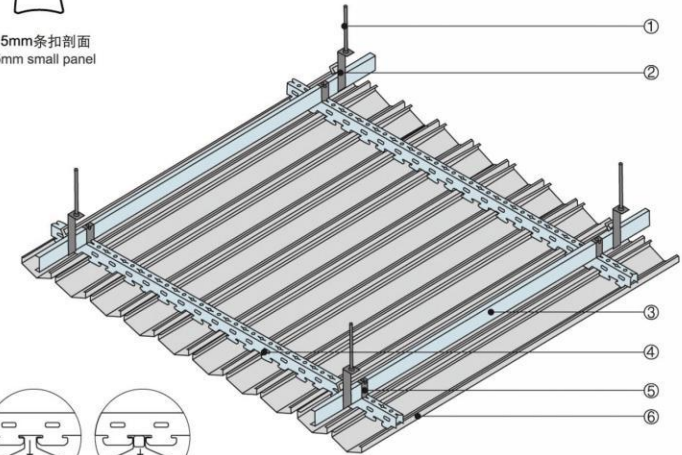

格栅天花系列 GRILLE CEILING SYSTEMS

格栅天花系列主骨、副骨纵横分布，由格与格的连续组合所构成的吊顶天花，能舒缓由于封闭式所造成的压抑感，令视觉效果连续平整，结构严谨。可根据色彩、规格、施工方法及照明能装饰出各种千变万化的天花吊顶。

Grille ceiling system enables open ceiling plane constructions, offering a wide variety of cells and patterns for maximum freedom of design. Our panels contain up to 95% recycled aluminum and are created with a proprietary manufacturing process that ensures clean lines and durability.

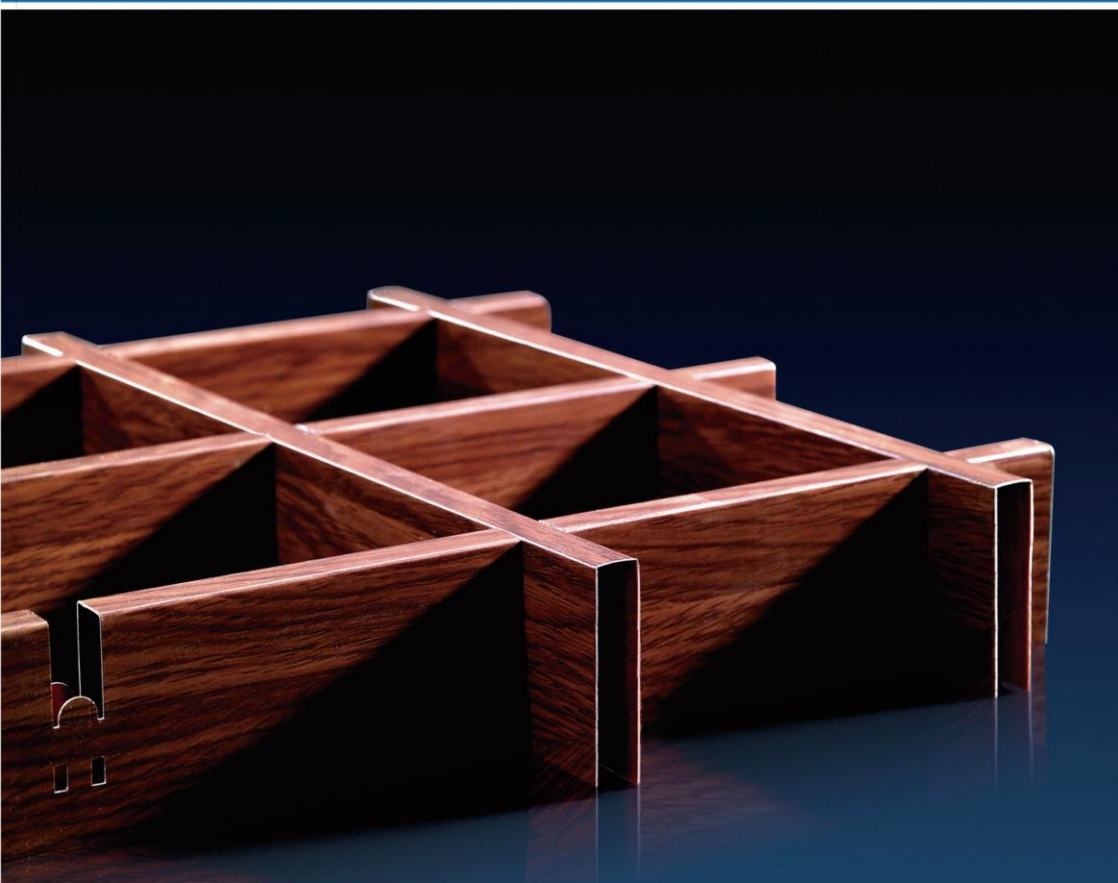

格栅天花系列 Grille Ceiling System

- 格栅天花，通风性能好，通透式结构，纵横交错的天花主副骨组合方格，线条挺直，经纬分明，具有掩饰视觉方向感；能有效舒缓空间带来的压抑感，适合大面积场所使用安装。



● 常用规格(Size):

W: 10mm底H: (30、35、40、45、50高)

W: 15mm底H: (50、60、80、90、100、110、120高)

W: 20mm底H: (50、60、70、80、90、100、110、120高)

安装示意图 Installation diagram

- ①吊杆
- ②38#吊件
- ③38#龙骨
- ④格栅主骨
- ⑤格栅吊件
- ⑥格栅副骨
- ①suspension rod
- ②38# carrier clip
- ③38# carrier
- ④Grille main carrier
- ⑤Grille clip
- ⑥Grille cross-carrier

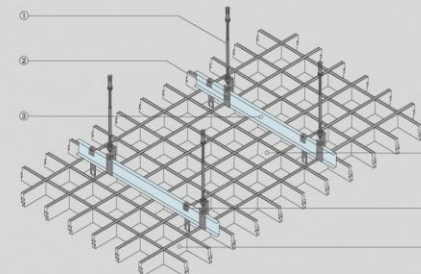

挂片天花系列 SCREEN CEILING SYSTEMS

挂片天花系列，极具方向性，通透开阔，立体感强，棱角线条清晰明朗，新颖独特。可调节装饰空间视觉高度，搭配各种不同颜色，悬挂不等高度，引入不同灯光效果，相益辉映，展现明快、飘逸、时尚、谐美的装饰风格。加以防风码安装结构，应用于室外装饰能有效防风，效果更鲜明。通透的安装方法，装拆简易快捷。

Screen ceilings offer best-in-class vane and carrier options that make them ideal for large spaces requiring a one-way plenum mask or specific lighting effects. An adjustable carrier system allows baffles to slide back for easy access to lighting, sprinklers, and diffusers.

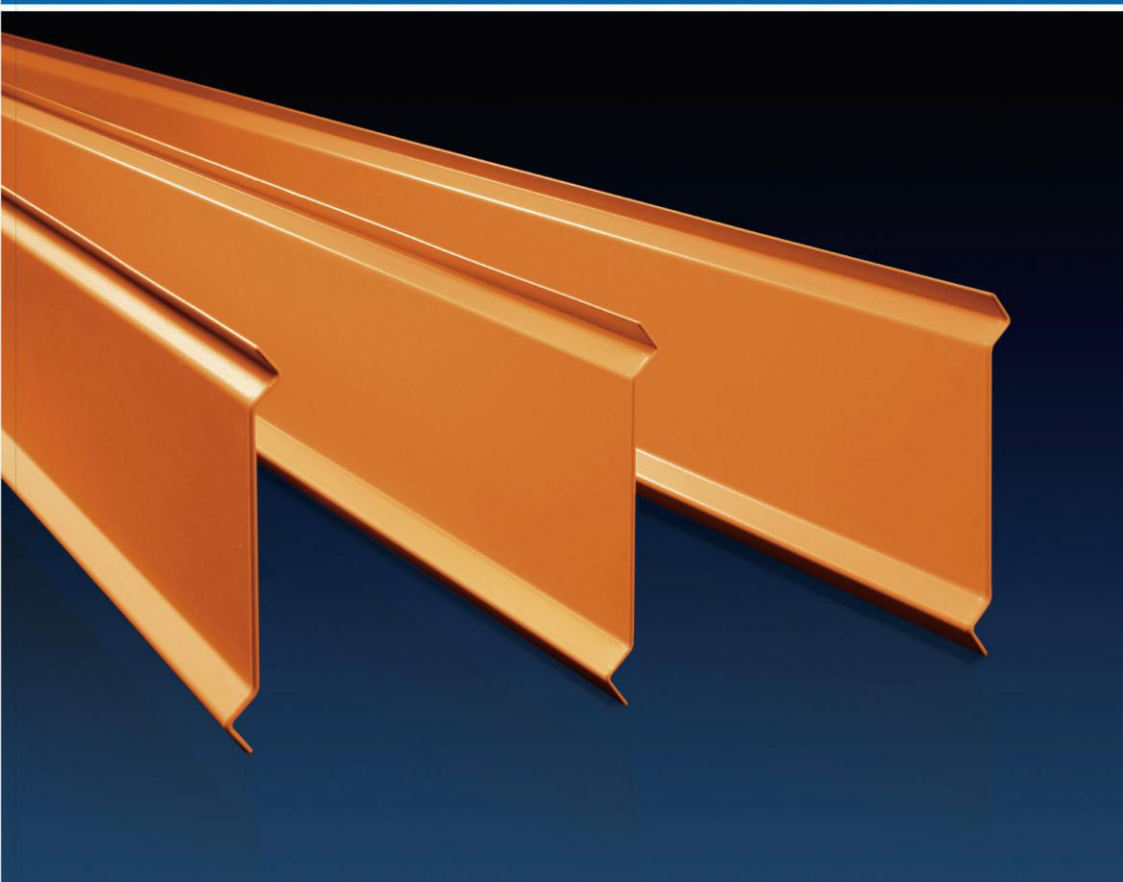

直插式挂片天花系列 In-line Type Screen Ceiling System

- 挂片吊顶，可调节房屋视觉高度，并可隐藏楼底的所有管道和其他设施，同时还可以使进入房间的日光或灯光柔和均匀。挂片天花由铝合金条板及龙骨组成，装拆灵活。直插式有75mm、85mm、110mm，以100mm、150mm间距固定于龙骨上，挂片天花不影响房屋的吸音以及消防喷淋、空调系列等设施的的安装，备有多种颜色可供选择。该产品适用于建材装饰、机场、地铁站等大型场所。

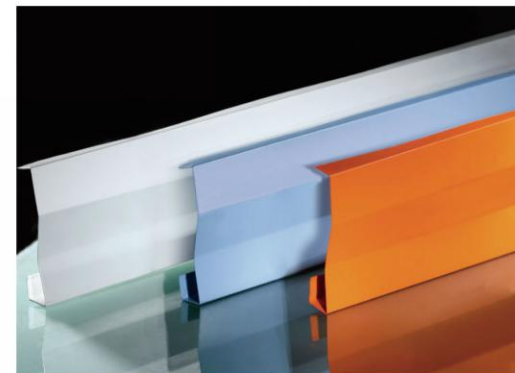

- 常用规格(Size): High75、85、110、110异型A、110异型B(mm)

安装示意图
Installation diagram

- ①主龙骨吊件
- ②主龙骨
- ③挂片
- ④吊杆
- ①Main carrier clip
- ②Main carrier
- ③Screen ceiling
- ④Suspension rod

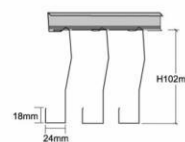
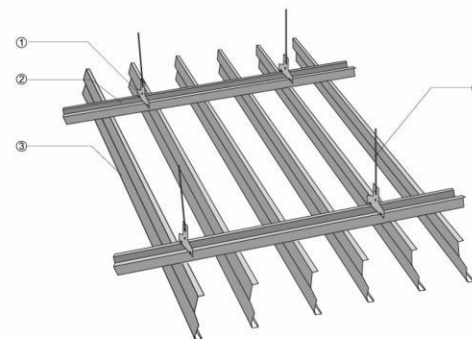

型号: 110B
TYPE: 110B

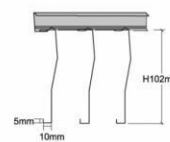

型号: 110A
TYPE: 110A

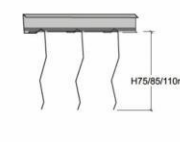

型号: 75高、85高、110高
TYPE: 75(height)、85(height)、110(height)

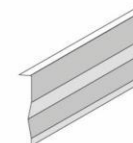

直插式挂片
In-line type screen ceiling

钩搭式挂片天花系列

Hook Type Screen Ceiling System

- 挂片天花可使长距离的空间显的更宽敞，使长形空间不再因为距离而产生局促感，简洁而不平板，充足的光感与次序感，更使空间充满时尚气息。
- 常用规格(Size): High 124mm、120mm



安装示意图 Installation diagram

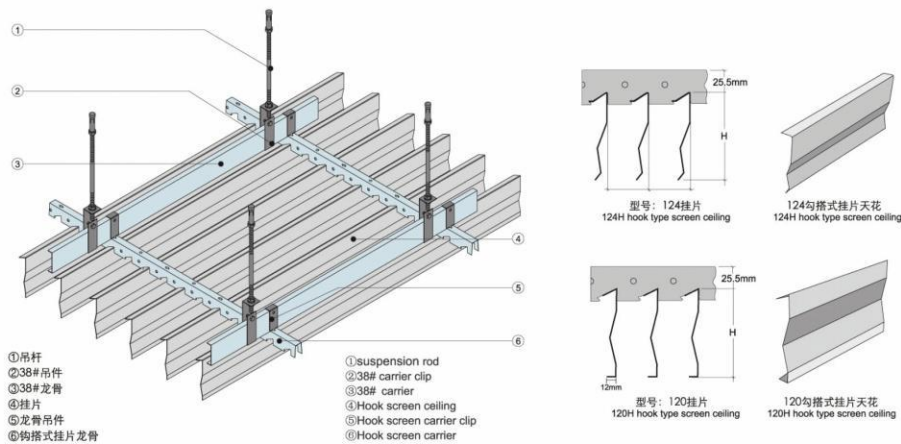

垂帘式挂片天花系列

Vertical Type Screen Ceiling System

- 这是一种装饰性天幕型吊顶，可调节房屋视觉高度，并可隐藏楼底的所有管道和其他设施，同时还可以使进入房间的日光或灯光柔和均匀。挂片天花由铝合金条板及龙骨组成，装拆灵活。钩搭式有124mm高，挂片天花绝不影响房屋的吸音以及消防喷淋、空调系列等设施的安装，备有多种颜色可供选择。该产品适用于建材装饰、机场、地铁站等大型场所。
- 常用规格(Size): High 100mm



安装示意图 Installation diagram

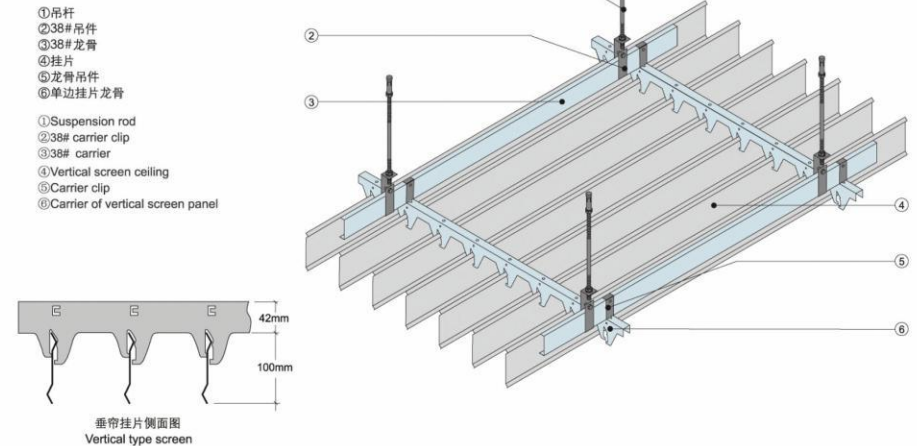

滴水挂片天花系列 Dripping Screen Ceiling System

- 1、开透式空间。
- 2、高度一致性，排列整齐。
- 3、有利于消防喷淋的布置和安排而不影响整体视觉效果。
- 4、可与明架系统配合。
- 5、色泽均匀一致，户内使用，质保10年不变颜色。
- 6、连接牢固，每件可重复多次装拆。
- 7、易于各种灯具和装置相配。
- 8、方便设备维修。

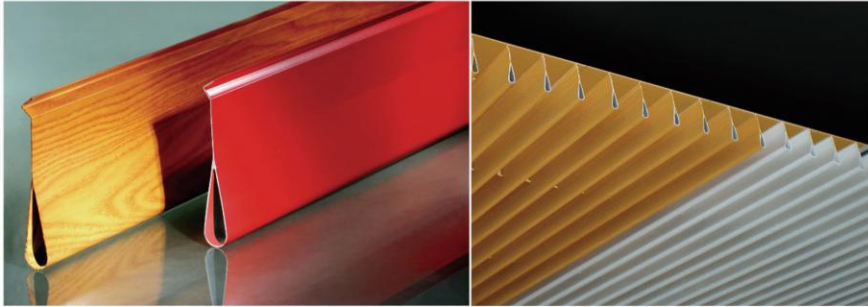

滴水挂片规格 (Size):

高度(Height): 110mm 直径(Diameter): 25、18mm 厚度(Thickness): 0.7、0.9mm

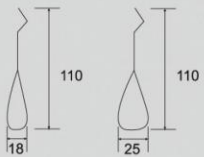
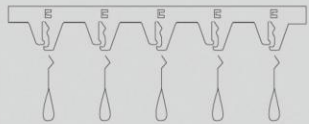

安装示意图 Installation diagram

- ①吊杆
- ②38#吊件
- ③38#龙骨
- ④滴水挂片
- ⑤龙骨吊件
- ⑥单边挂片龙骨

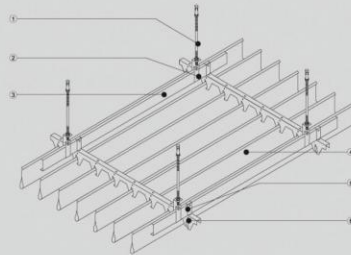

屏障天花系列 BAFFLE CEILING SYSTEMS

屏障天花系列，极具方向性，通透开阔，立体感强，棱角线条清晰明朗，新颖独特。可调节装饰空间视觉高度，搭配各种不同颜色，悬挂不等高度，引入不同灯光效果，相益辉映，展现明快、飘逸、时尚、谐美的装饰风格。加以防风码安装结构，应用于室外装饰能有效防风，效果更鲜明。通透的安装方法，装拆简易快捷。

Baffle ceilings offer best-in-class vane and carrier options that make them ideal for large spaces requiring a one-way plenum mask or specific lighting effects. An adjustable carrier system allows baffles to slide back for easy access to lighting, sprinklers, and diffusers.

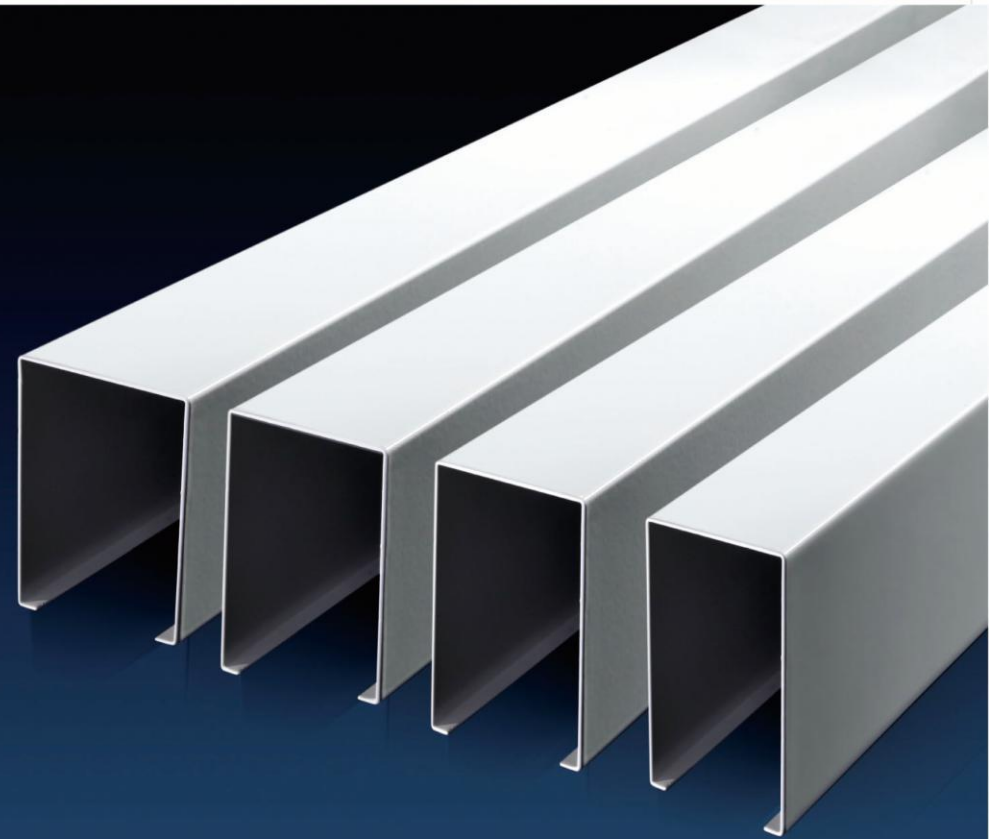

U型挂条通透式天花系列

U-Shaped Baffle Sealing System

这是一种全新的，有别于传统的新型天花格条，选用优质铝材，精密加工成型，并提供丰富的色彩选择，开放式的吊顶营造出了优美大方的造型和富于变化的色彩空间，为图书馆、高档写字楼、展厅等场所提供了完美的天花吊顶方案。

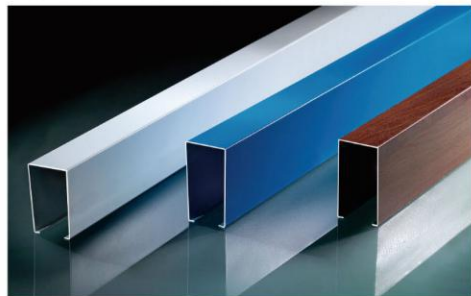

常用规格(SIZE):

普通底宽: Width 25、30、40、50、60、70、80mm, 高度: High 30-200mm

超宽底宽: Width 100、110、120、130、140、150、160、170、180、190、200mm, 高度: High 20-50mm



安装示意图

Installation diagram

- ①吊杆
 - ②38#吊件
 - ③38#龙骨
 - ④U型平面条扣
 - ⑤U型挂条 龙骨吊件
 - ⑥U型条扣龙骨
- ①Suspension rod
 - ②38# fitting carrier
 - ③Main carrier
 - ④U-shaped hanging ceiling
 - ⑤U-shaped hanging carrier clip
 - ⑥U-shaped hanging carrier

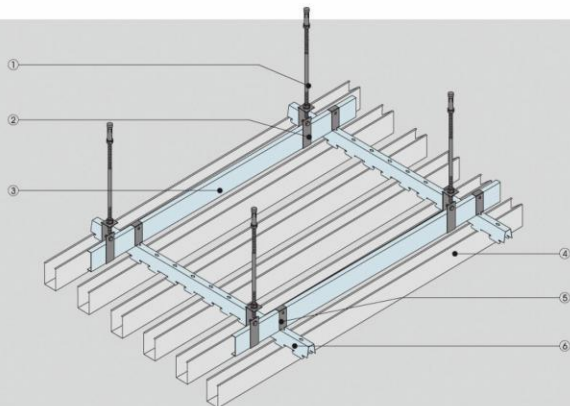

机翼型天花系列

Bullet-Shaped Baffle Ceiling System

机翼型天花可使长距离的空间显的更宽敞，使长形空间不再因为距离而产生局促感，简洁而不平板，充足的光感与次序感，更使空间充满时尚气息。



安装示意图

Installation diagram

- ①吊杆
 - ②50#圆管方管龙骨
 - ③机翼型天花
 - ④螺丝
- ①Suspension rod
 - ②50# shaped ceiling carrier
 - ③Bullet Shaped ceiling
 - ④Screw

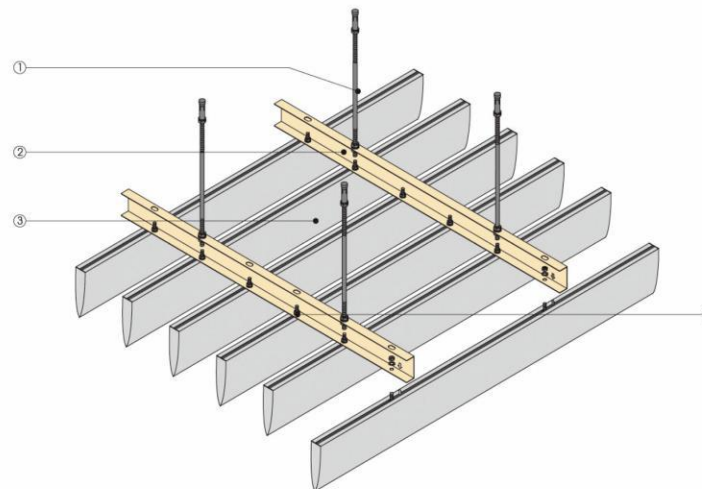

型材方管天花系列

Quadrate-Pipe Baffle Ceiling System

型材方管天花，极具方向性，通透开阔，立体感强烈，棱角线条清晰明朗，新颖独特。可调节装饰空间视觉高度，搭配各种不同颜色，悬挂不等高度，引入不同灯光效果，相益辉映，展现明快、飘逸、时尚、谐美的装饰风格。加以防风码安装结构，应用于室外装饰能有效防风，效果更鲜明。通透的安装方法，装拆简易快捷。

常用规格(SIZE):

Width 25mm底 (High 50、60、70、80、90、100mm高) Width 30mm底 (High 50、60、70、80、90、100mm高)

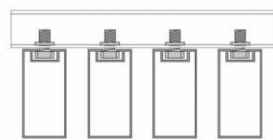
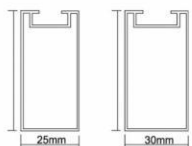
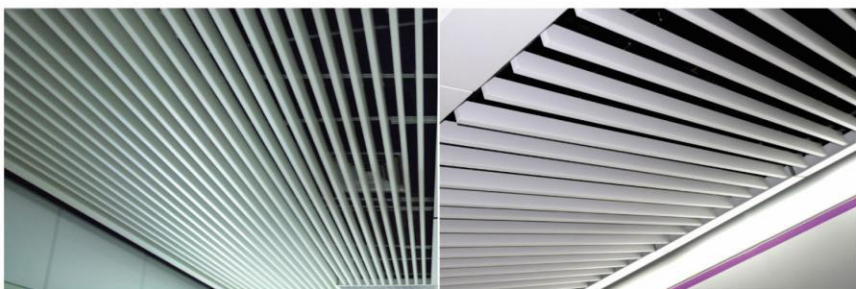

螺丝挂扣式安装方法
Screw linked installation

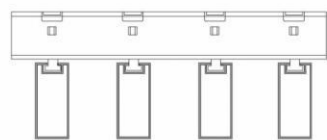

龙骨挂扣式安装方法
Carrier linked installation

安装示意图 Installation diagram

- ①吊杆
- ②50#圆管方管龙骨
- ③方型铝通
- ④螺丝
- ⑤方型铝通封头盖
- ①Suspension rod
- ②50# shaped ceiling carrier
- ③quadrate-pipe
- ④screw
- ⑤Cover of quadrate-pipe

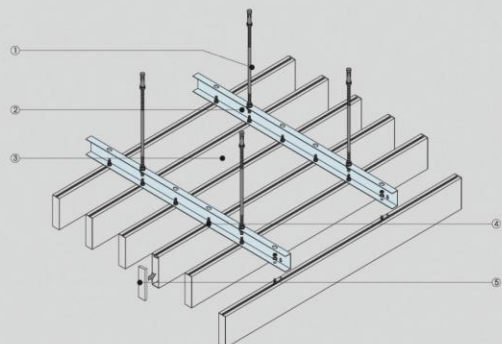

型材圆管天花系列

O-Shaped Pipe Baffle Ceiling System

型材圆管通透式天花，是一种环保产品，把人们生活中常见的圆管，加以改变，添加牢固科学的安装结构，广泛应用于高级大型场所的天花装饰。

常用规格(SIZE):

Pipe I 凸型圆管 (Diameter 50mm直径)
Pipe II 凹型圆管 (Diameter 50mm直径)

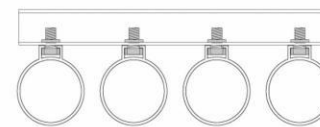
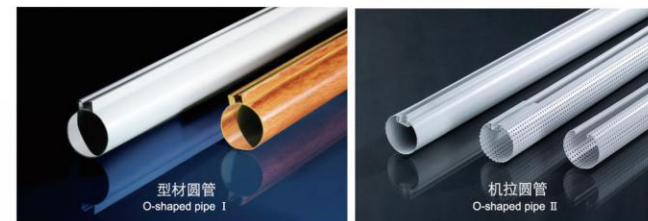

螺丝挂扣式安装方法
Screw linked installation

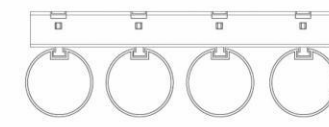

龙骨挂扣式安装方法
Carrier linked installation

安装示意图 Installation diagram

- ①吊杆
- ②50#圆管方管龙骨
- ③圆型铝通
- ④螺丝
- ⑤圆型铝通封头盖
- ①Suspension rod
- ②50# shaped ceiling carrier
- ③Round aluminum pipe
- ④screw
- ⑤Cover of Circular-pipe

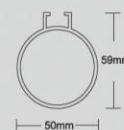

φ 50圆管挂条
φ 50Pipe I



φ 50圆管挂条
φ 50Pipe II

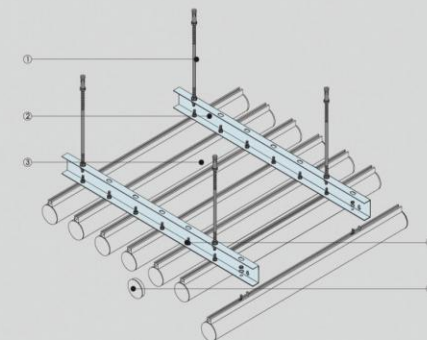



勾搭式天花系列

HOOK-ON TILE CEILING SYSTEM

勾搭式天花，根据实际空间的需要，灵活设计天花板面的尺寸。固定龙骨系统后，可徒手装卸，不需任何辅助工具，灵活简易。龙骨系统配有防风码结构，其功能可以在暴风气候下，结构牢固。适合设计成各种装饰效果及形状。被广泛应用于天花活动性能要求较高的场所。

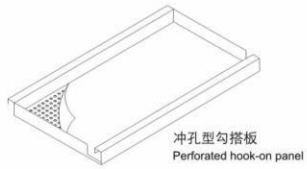

冲孔型勾搭板
Perforated hook-on panel

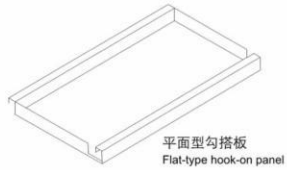

平面型勾搭板
Flat-type hook-on panel

安装示意图 Installation diagram

- ①吊杆 ①Suspension rod
- ②38#吊件 ②Main carrier clip
- ③38#龙骨 ③38# carrier
- ④平面型勾搭板 ④Hook-on panel
- ⑤勾搭式龙骨吊件 ⑤Hook-on carrier clip
- ⑥勾搭式龙骨 ⑥Hook-on carrier

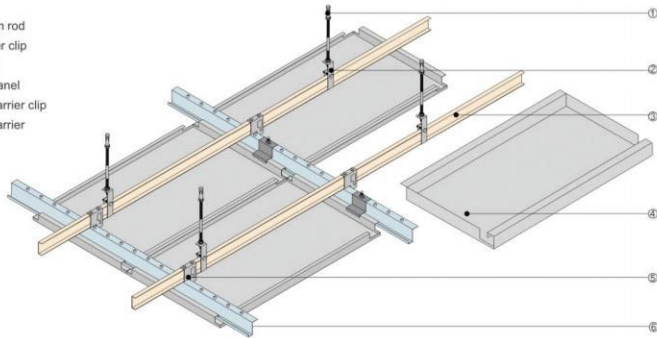

异型天花系列 CUSTOM CEILING SYSTEMS

金属异型设计时尚，可通过不同的组合搭配方式演绎出千变万化、结构奇异的吊顶，高贵典雅，经久耐用。联兴造型天花融合现代装饰设计的实用与美学结合的方式设计，完全可依据工程实际需要而专门订造，以求达到完美体现设计的装潢效果，日益成为金属吊顶的新宠。

Custom ceiling systems from us-Form, fit and function for your most prestigious projects. You have a specific vision and you need a partner who has the expertise and ability to get it done. We has custom ceiling solutions to fit uou. Let us use over 20 years of ceiling system experience to solve your specific challenges. Our team will assist you with: Applying perforated metals for sound control. Forming and finishing panels to create distinctive designs for ease of installation and maintenance.



型材方通天花系列

PROFILE SQUARE SERIES

产品特点

PRODUCT CHARACTERISTICS

- 形状：方型长条
- 材质：AA级铝合金
- 自定义类型：特殊尺寸、表面颜色、安装配套可安需求做
- 制造工艺：模压成型、铝型材
- 安装系统：U型长条通透式D20~200（底）、H20~300（高）长度≤5000mm
- 标准厚度：0.8-1.2mm
- 表面处理：Akzo Nobel静电粉末喷涂、涂厚0.06~0.1mm。多种标准颜色，能满足色彩设计要求

产品展示

PRODUCT PRESENTATION

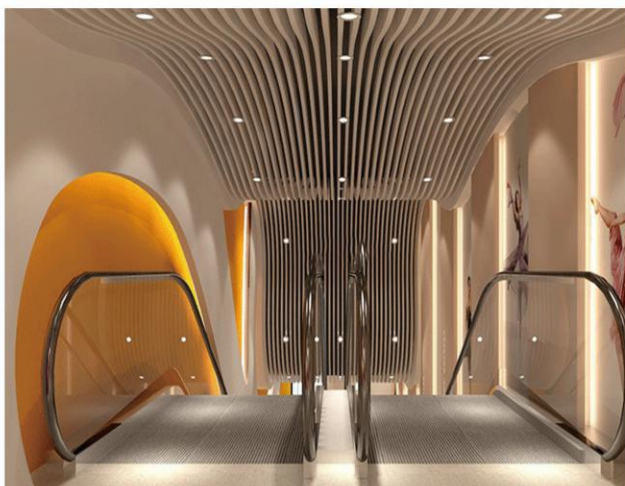

产品样品实拍图

PRODUCT SAMPLE PHOTOGRAPH

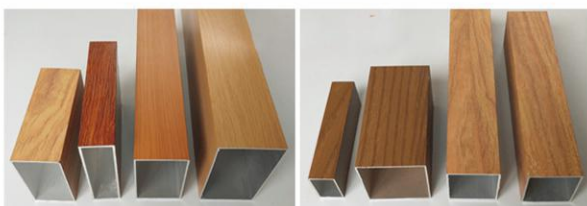

Shape: square strip

material : AA aluminum alloy

Customer require type: special size、surface color、matched installing

Producing skill: molding、aluminum profile

Installation system: U-type long - strip transparent D20-200 (bottom), H20-300 (high), length ≤ 5000mm

Standard thickness: 0.8-1.2mm

Surface treatment : Akzo Nobel electrostatic powder spraying , coating thickness 0.06-0.1 mm , many kinds of standard colors , which can meet the requirements of color design.

型材方通系列天花安装示意图

profile square installation

铝型材屏条方通天花 单位: mm

宽度(W)	高度(H)	厚度(T)	示例 illustration
25	50-200	0.8-2.0	
30	50-200	0.8-2.0	
50	70-250	1.0-2.0	
75	100-250	1.0-2.0	

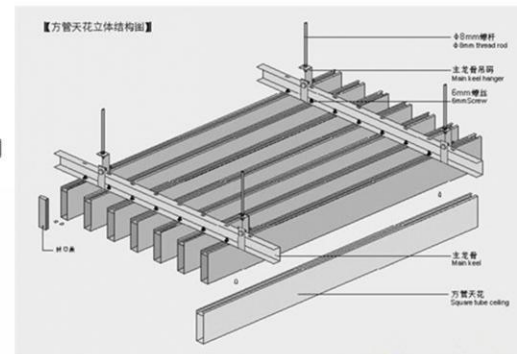
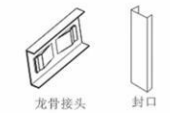
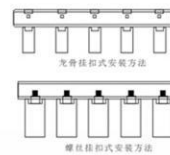
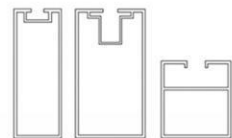

型材天花具有通透的结构, 优良的排气效果采用单向条板安装, 形成单向屏级视觉, 造型美观, 线条明快飘逸, 简约大方, 若适当地选用高度, 其空间的视觉角度则能产生幕布的效果, 令设计变化万千, 整个建筑空间宽畅通透, 更具天花行业的时尚感!

Section ceiling has a transparent structure , excellent exhaust effect using one-way slab installation, the formation of a one-way screen level vision , beautiful shape, bright and elegant lines, about generous, if the proper selection of height, the spatial visual angle can produce the effect, make design changes, the whole building space more spacious and transparent, small pox Industry fashion sense!



铝单板系列

ALUMINUM SINGLE PLATE SERIES

产品特点

PRODUCT CHARACTERISTICS

铝单板幕墙采用优质高强度铝合金板材，其常用厚度为2.0,2.5,3.0.型号为3003状态为H24。常规材料最大尺寸为1220mmX2400mm,其构造主要由面板、加强筋和角码组成。角码可直接由面板折弯、冲压成型，也可在面板的折边上铆装角码成型。加强筋与板面后的电焊螺钉联接，使之成为一个牢固的整体，极大增强了铝单板幕墙的强度与刚性，保证了长期使用中的平整度及抗震能力。如果需要隔音保温，可在铝板内侧安装高效的隔音保温材料。

产品展示

PRODUCT PRESENTION



产品样品实拍图

PRODUCT PRESENTATION



The product features aluminum veneer curtain wall using high-quality high-strength aluminum alloy sheet, its commonly used thickness is 2.0 2.5, 3.0, the model is 3003 status H24. The maximum size of conventional materials is 1220mm x 2400mm, and its construction is mainly composed of panels, stiffeners and corner codes. Corner code can be formed directly by bending and stamping of the panel or riveted on the edge of the panel. The steel bar is connected with the welding screw behind the plate surface, which makes it a solid whole. It greatly enhances the strength and rigidity of aluminum veneer curtain wall, and ensures the smoothness and anti-seismic ability in long-term use. If sound insulation is required, an efficient sound insulation material can be installed on the inside of the aluminum plate.

铝单板结构图

ALUMINUM VENEER STRUCTURE

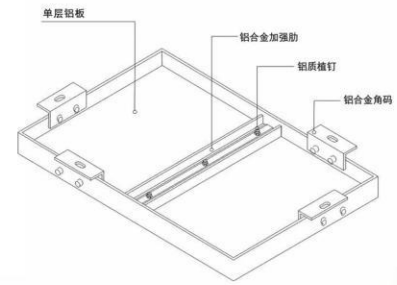
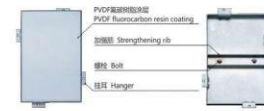

单层铝板结构图 Structure Diagram of Single-layer Aluminium Plate

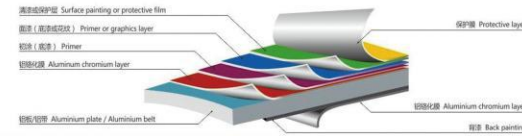

到目前为止，金属幕墙中的铝板幕墙一直在金属幕墙中占主体地位，轻量化的质，减少了建筑的负荷，为高层建筑提供了良好的选择条件；防水、防污、防腐性能优良，保证了建筑外面持久长新；加工、运输安装施工等比较容易施工，为其广泛使用提供强有力的支持；色彩的多样性及可以组成加工成不同的外观形状，拓展了建筑师的设计空间；较高的性能价格比，易于维护，使用寿命长，负荷业主的要求。铝单板应用场所：建筑物外墙、梁柱、阳台、机场、车站、医院、会议厅、歌剧院、体育场馆、接待大堂等

So far, the metal curtain wall aluminum curtain wall has been dominant in the metal wall, light quality, reduce the construction load, provides good conditions for high-rise building; waterproof, anti fouling, anti corrosion performance, ensure the external surface of abuilding lasting Changxin; processing, transportation, installation and construction it is easy to implement, and provide strong supportfor the widespread use of diversity; color and processing can be combined into different shapes, expand the design space of architects; ahigher ratio of performance to price, easy maintenance, long service life, meet the requirements of the owners. Applicain ofaluminum veneer: building exterior wall, Liang Zhu, balcony, irport, station, ospital cnferee all, peraHospitalstadium, reception hall and other high-rise buildings.



长城板系列

THE GREAT WALL BOARD SERIES

产品特点

PRODUCT CHARACTERISTICS

长城板背景墙，是一种新颖的金属背景墙产品，根据现在热销铝方通和生态木综合改造而成，是一种新颖，时尚，装饰效果好，防火防潮的背景墙产品，以前，很多人可能用生态木作为背景墙，几乎生态木垄断了很大的背景墙市场份额，但是，随着很多工程场合消防要求不断提升，生态木燃点低，金属背景墙逐渐受到市场的重视，越来越多的设计，各种背景墙使用到铝合金背景墙，而长城板背景墙，正是受市场追捧的一种。

- 产品具有耐老化、抗紫外线、耐酸碱、重量轻、刚性好、强度高，结构合理。抗风压变形性能，抗雨水渗漏和抗空气渗漏，抗震性能均能满足结构设计要求；
- 具有良好的抗压、抗冲击等物流机械性能和良好的再加工性。
- 产品耐油、耐污、易清洁、使用寿命为30年以上，产品适于人居环境、可回收利用、绿色环保。

应用

APPLICATION

应用场景长城板广泛应用于家装、工装、酒店、大堂、4S店等休闲娱乐场所工程等各个方面。

The Great Wall Board is widely used for leisure entertainment such as home wear, furniture, hotel, lobby, 4S shop, etc.. Music site engineering and other aspects.

The Great Wall board background wall is a kind of novel metal background wall product, it is modified from the current hot-selling aluminum square pass and the raw wood comprehensive transformation, it is a kind of new fashionable fireproof and moisture-proof background wall product with good decoration effect. Long age, many people may use eco-wood as a background wall, which almost monopolizes a large market share of the background wall. However with the increasing demand for fire protection in many engineering occasions, because of the low fire point of eco-wood. The metal background wall has been paid more and more attention by the market, and more design, all kinds of background wall make use of aluminum alloy background wall, and the Great Wall plate background wall, is one of the most popular background walls in the market.

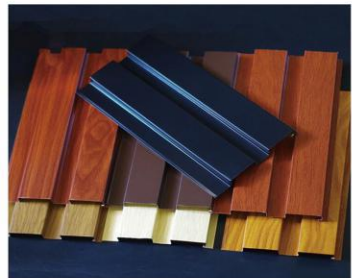

适用场景

APPLY SCENARIO



背面烤漆工艺

On the back of the lacquer that bake process

铝合金材质、使用寿命长达30年

长城板防水测试

The Great Wall board waterproof test

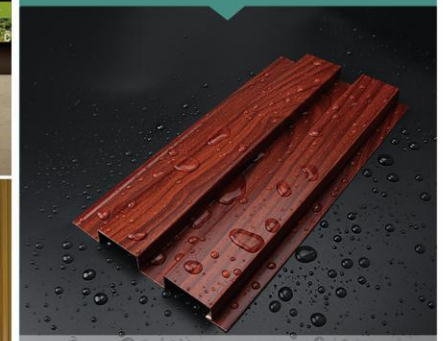

防水防潮、完美的将水与墙体隔绝、使用寿命强





高抗腐蚀的特性使得人流密集的场所更加适于广泛应用；良好的环境适应性使其应用更为广泛。



幕墙铝单板重量轻、强度高、防水、防污、防火、防蚀、加工性能好、维护费用低、使用寿命长。铝单板可加工成各种弧形及异形，表面可喷涂成多种颜色，在墙面形成各种美丽的图案，使建筑物更具高贵典雅的风格。

Installation Diagrams

铝单板墙体安装实例

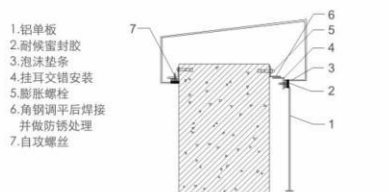

铝单板节点安装实例

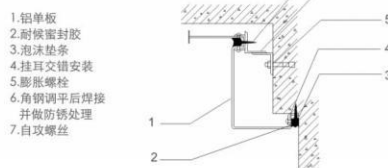

幕墙板安装示意图

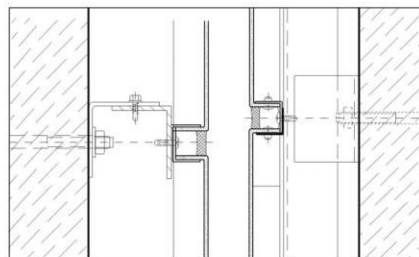

铝单板包方柱安装实例

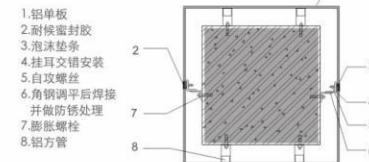

铝单板包圆柱安装实例

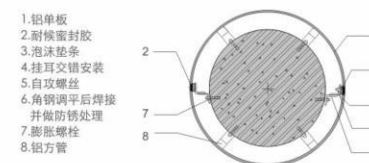

铝单板外部转角安装实例

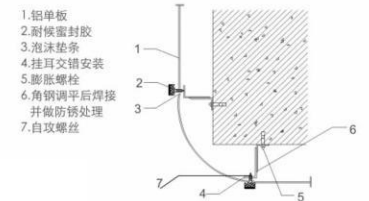

铝单板内部转角安装实例

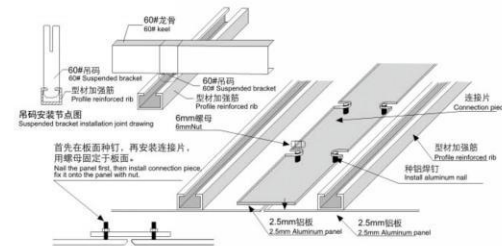

板与板连接节点图
Panel and panel connection joint drawing



产品特点 Product Features LIGHTING

产品特点 Product Features

- 【高效节能】：节能，亮度高，无红外线，无紫外线，无热效应，无辐射无光闪现象；最新LED平板灯的高效（95%）恒流驱动器；
- 【明亮匀光】：明亮的光线完全平面输出，发光角度更宽；
- 【超薄超轻】：专用电路设计，避免单一的坏灯影响整体的效果；
- 【稳定耐用】：5年使用期限，不受无线电干涉，不会污染环境。

应用领域 Applied Area

■ 广泛应用于地铁、隧道、办公室、商场、医院、家庭、酒店、走廊等室内照明。



LED 平板灯(宽边)
规格：
600x600mm 300x1200mm
600x1200mm



LED 平板灯(窄边)
规格：
600x600mm 300x1200mm
600x1200mm

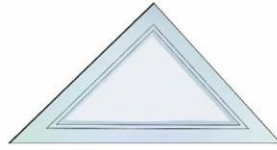

LED 平板三角形灯
规格：
780x780x1100mm



型号：B300LED-1 (300mmx300mm) 9W
B450LED-1 (300mmx450mm) 20W
B600LED-1 (300mmx600mm) 25W
B600x600LED-1 (600mmx600mm) 32W



型号：B450LED-2 (300mmx450mm) 20W
B600LED-2 (300mmx600mm) 25W
B600x600LED-2 (600mmx600mm) 32W



型号：B450LED-3 (300mmx450mm) 20W
B600LED-3 (300mmx600mm) 25W
B600x600LED-3 (600mmx600mm) 32W

换气系列 VENTILATION SERIES

新一代抽气扇，采用阿基米德原理和立倒风设计，有效实现大功率、强排风、超静音、加大抽气使整体性能提高，独有的风道设计，使通风能力大大超过普通抽气扇的排风量，时刻保持室内空气的清新，抽气象呼吸一样自由！而且运行寿命长的特点，是抽气通风最佳选择。



B300YH-2 300x300



B300YH-4 300x300



LED线条灯 LED LINER LAMP

产品特点 Product Features

灯具外壳采用铝合金控制而成，线条鲜明，结构简单，外形美观、坚固、耐腐蚀，安装方便。灯具表面静电喷塑处理，耐高温、耐候性能良好。反射器采用进口阳极氧化铝板，确保光能量的高输出。3MM厚的高强度钢化玻璃，透光率高，耐冲击。内置的保证防护等级可达IP65。技术参数表型号:HX-XQ颜色范围:红、黄、蓝、绿、白及彩色光束角度:15°-60°光线照射距离:20米控制系统:DMX512控制器或洗墙灯筒易控制器外壳材质铝合金连接方式标准信号电源线接头3针信号接头

结构特点 Structural Characteristics

LED线条灯即LED洗墙灯系列铝型材灯体，紧凑轻巧端盖和安装支架由铝合金高压压铸耐高温硅橡胶密封圈，保证防水的可靠性。灯具可单个或多个组合安装。适用于各种建筑物，室内外局部或轮廓照明。



产品实拍 Product Reality



● 滚涂色卡

POLLER COAT COLOR CARD



● 滚涂色卡

POLLER COAT COLOR CARD



LSLON木纹1



LSLON木纹2



LSLON木纹3



黑色



滚涂深灰



咖啡色



黄色



绿色



滚涂浅灰



红色



天蓝色

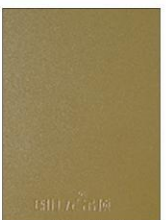

珠光金



浅咖啡



棕由木



浅拼木



深樟木



啡橡木



深栓木



深胡桃



棕胡桃



啡由木



浅栓木



黑胡桃



红木纹



黄花梨



香樟木



橡木纹

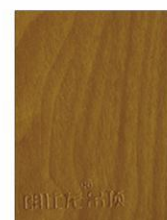

橘栓木



香森木



深花梨

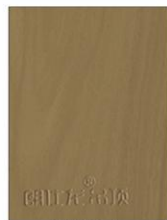

胡桃木



白橡木



纳米白



米白



浅咖啡



滚涂闪银



原色拉丝



LY1



LY2



LY3



LY4



LY5



LY21



LY22



LY23



LY24



LY25



LY6



LY7



LY8



LY9



LY10



LY26



LY27



LY28



LY29



LY30



LY11



LY12



LY13



LY14



LY15



LY31



LY32



LY33



LY34



LY35



LY16



LY17



LY18



LY19



LY20



LY36



LY37



LY38



LY39

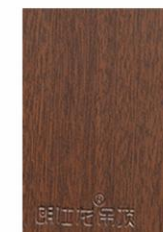

LY40



LY41



LY42



LY43

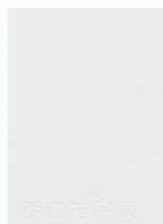

LY44



LY45

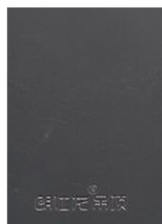

LY46



LY47

蜂窝板系列

ALUMINUM HONEYCOMB PANELS

产品特点

ALUMINUM HONEYCOMB PANEL PROFILE

● 铝蜂窝板是引进国外先进的复合设备,采用热熔性粘接剂研制而成的一种全新的复合材料,克服了传统蜂窝板粘接层脆性,抗撕裂程度和抗冲击性低、加工性差、成本高的缺点,从而开创了铝蜂窝板得到广泛应用的新局面。铝蜂窝板具有极轻的重量和极高的强度和刚性,以及优美的表现装饰性和长时间的使用寿命,因此应用极为广泛,如幕墙、车厢、船体、尤其在建筑上,可承受高压,满足大风格要求,还具有非常好的平整性。

We bring the complex equipment from German to produce Aluminum Honeycomb planking. We adopted a fresh complex materials which was study and developed inheating to cohere. It recovered the short weak cohere, tear-resistant, lash-resistant, processable and high cost. Thereby, it start the new situation of Aluminum Honeycomb planking using market.

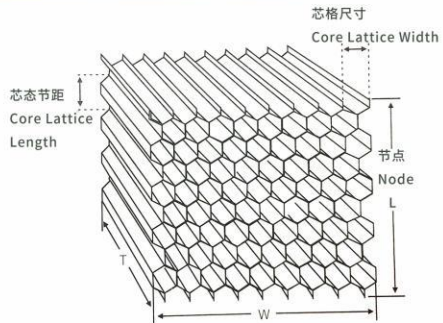

蜂窝芯立体平面图

Stereoscopic Diagram of Honeycomb Core

L:纵向(平行于胶条)
Length (Parallel to adhesive strip)
W:横向Width(垂直于胶条)
Width (Perpendicular to adhesive strip)
T:厚度Thickness

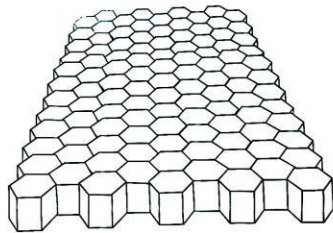

铝蜂窝芯结构图

Structural Diagram of Aluminum Honeycomb Panel



铝蜂窝芯

Aluminum Honeycomb Core

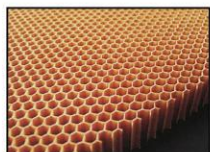

纸蜂窝芯

Paper Honeycomb Core

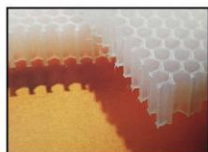

塑料蜂窝芯

Plastic Honeycomb Core

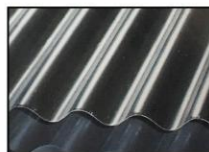

瓦楞芯

Corrugated Honeycomb Core

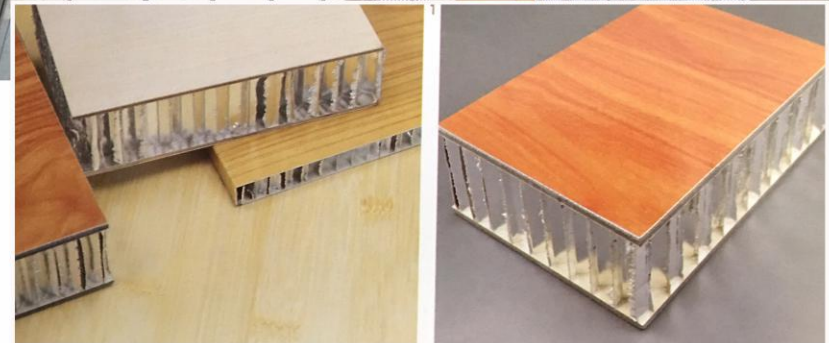
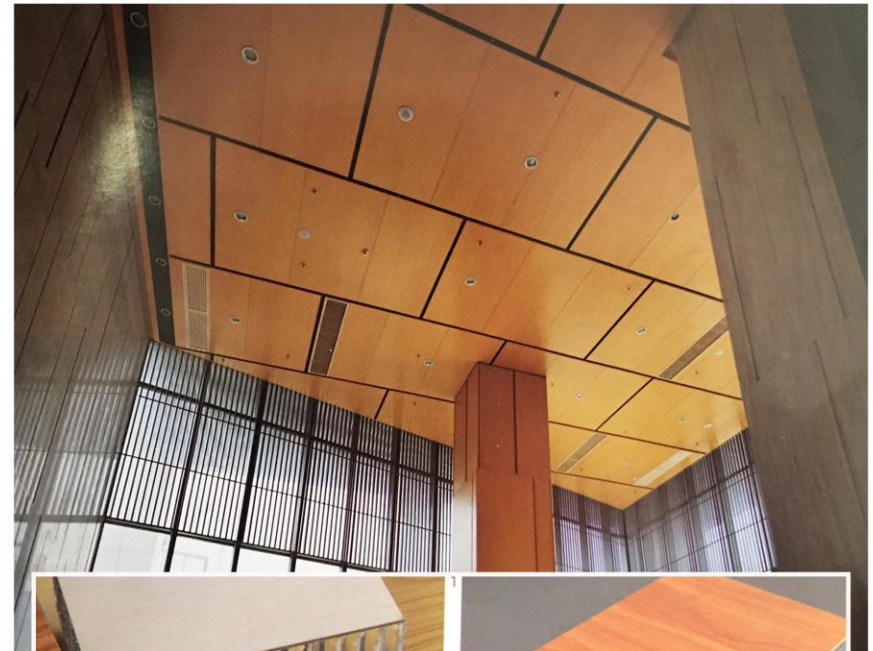

幕墙安装方法

INSTALLATION OF CURTAIN WALL

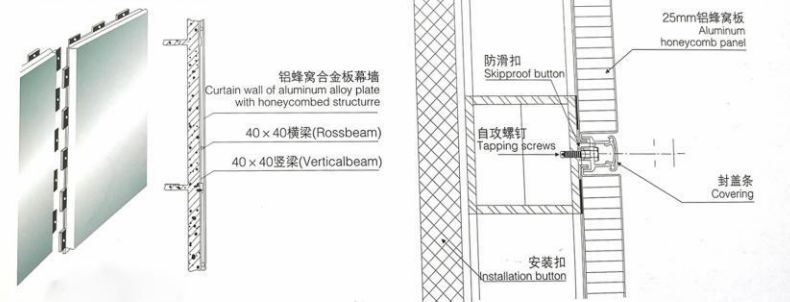

蜂窝幕墙板及侧视图

Curtain wall with honeycombed plate and the side view

铝屏风系列

ALUMINUM SCREEN SERIES



清幽别致，和谐典雅

典雅中带着不羁，别致里透着高贵如银河流淌，有着清丽脱俗之美。

Beautiful and unique, elegant and harmonious
Elegant chic with uninhibited, inged with noble
Such as the Milky Way flowing, with elegant and refined beauty.

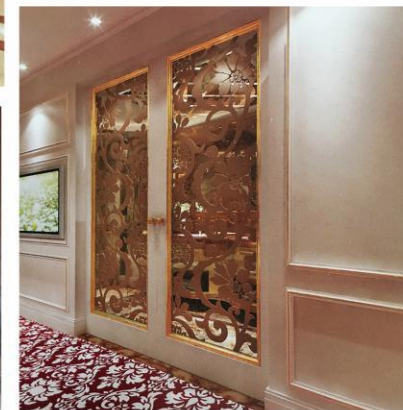
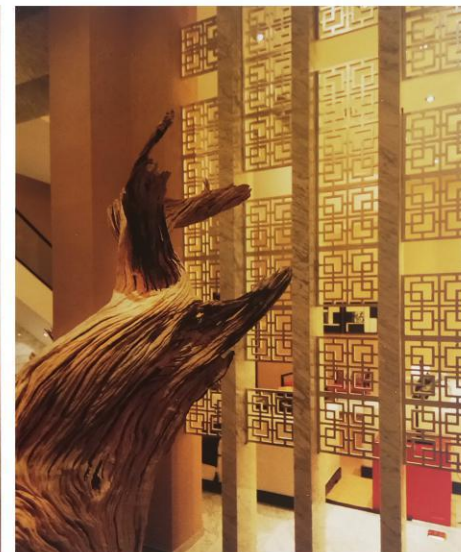
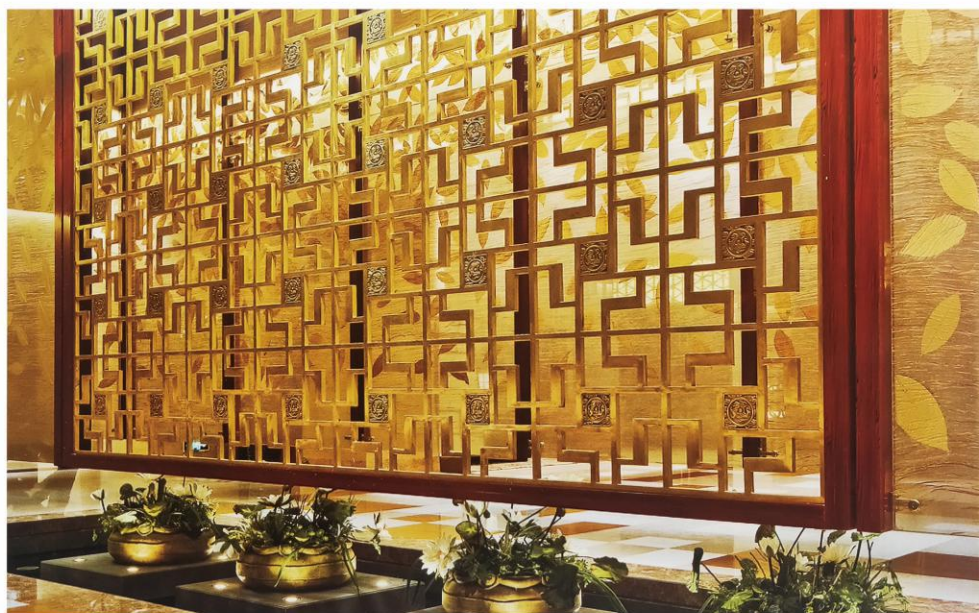

筛网板系列 SIEVE PLATE

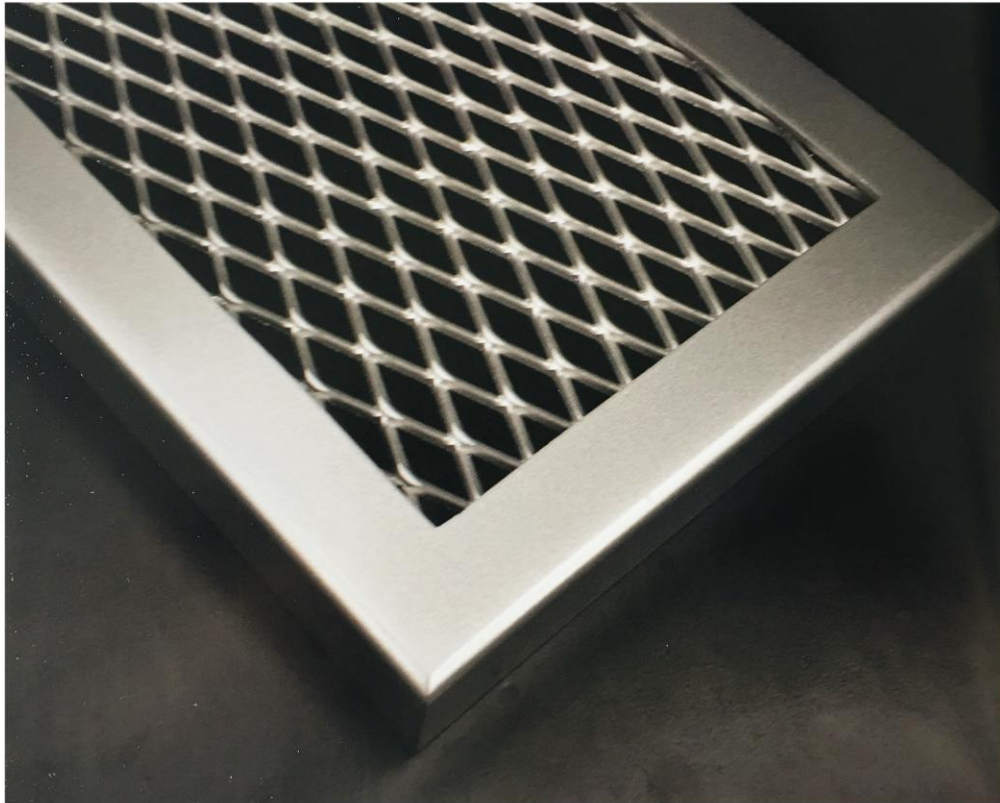

筛网板特点

The characteristics of screen plate

- 开透式空间
 - 优质铝合金板
 - 有利于通风设施和消防喷淋的布置和安排而不影响整体视觉效果
 - 可与明架系统配合
 - 色泽均匀一致，户内使用，质保10年不变颜色
 - 连接牢固，每件可重复多次装拆
 - 易于各种灯具和装置相配
 - 方便设备维修
- Open through type space
 - High quality aluminum alloy plate
 - For ventilation facilities and fire sprinkler layout and overall arrangement and does not affect visual result
 - And the suspension system
 - Color uniform, use, 10 years of constant quality
 - Conjunction, everything can be repeated many times installation
 - To all sorts of lamps and lanterns and device to match
 - Convenient maintenance.



瓦楞板系列

CORRUGATED BOARD

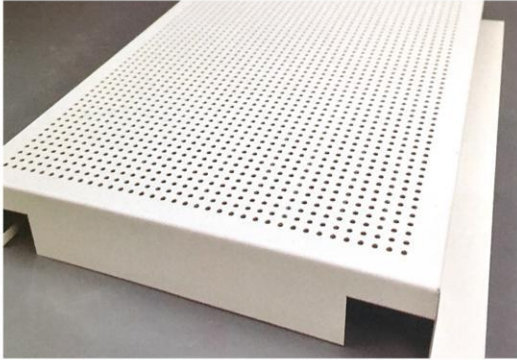

瓦楞板具有流畅的波纹状外形，能满足各类传统和现代的设计风格。能完美地表达建筑师的设计创意，倍受建筑师的青睐。瓦楞板也叫做压型板，采用铝板、彩色涂层钢板、镀锌板等金属材料经辊压冷弯成各种波型的压型板，它适用于工业与民用建筑、仓库、特种建筑、大跨度钢结构房屋的屋面、墙面以及内外墙装饰等。具有质轻、高强、色泽丰富、施工方便快捷、抗震、防火、防雨、寿命长、免维护等特点，现已被广泛推广应用。

性能特点:

- 富有灵感的波浪设计充分满足各类现代的建筑创意;
- 板型长而宽
- 可以自然成弧，最小曲率半径为12m;
- 外形美观，多种颜色选择;|安装快捷简便
- 价值出众的屋面和墙面维护系统;
- 平整性:因改善了在金属普通铝单板上发生的扭曲和弯曲的现象所以能维持其优越的平整性。
- 耐候性:铝板表面涂覆耐候性极佳的PVDF氟碳树脂。
- 易加工性: 可切割、连接、折弯，弯圆等多样的方法加工 防火质量轻 节能环保:全部采用铝合金材质。

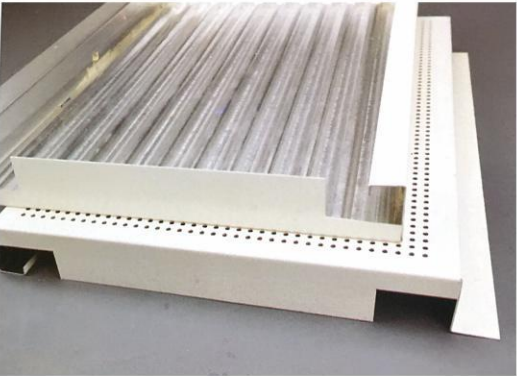

Corrugated board with smooth corrugated shape, can meet all kinds of traditional and modern architectural style. Creative design can perfectly express the architects, by architects. Corrugated board is also called pressure plate, by aluminum, color coated steel plate, galvanized sheet, etc. metal plate after rolling and cold bending into various wave types of pressure plate. It is used in industrial and civil building, warehouse, construction, large span steel structure housing roof, walls and interior and exterior wall decoration. Of a lightweight, high strength, color rich, convenient and quick construction, earthquake, fire, rain, long service life, maintenance free characteristics, has been widely applied. Performance characteristics: inspired wave design fully meet all kinds of modern architectural creativity; board type long and wide into the natural arc, the minimum radius of curvature for the 12m; appearance, a variety of colors; quick and easy to install. Superior roof and indoor maintenance system; in the ordinary Tomuono improved using and bending phenomenon occur inferior smoothness. metal aluminum single board to maintain its super weather resistance; stance PVDF fluorine aluminum coated-carbon resin, with excellent weather resistance. It is light weight, aluminum alloy saving and environmental protection: All aluminum alloy material.

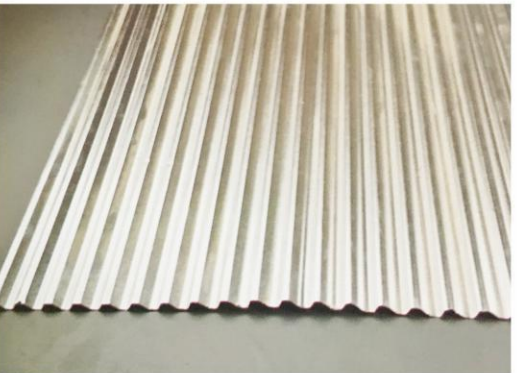

瓦楞板应用案例

CORRUGATED BOARD APPLICATION CASES



部分工程项目

SOME ENGINEERING CASES



江苏溧水高铁站

上海万达苏宁极物

上海苏宁易购

苏州万科遇见山

杭州附属医院

上海同济大学

上海万达广场

上海嘉定一中

杭州正达文化园

安徽古井产业园

上海松江九峰学校

上海美格菲健身中心

上海国际赛车场

杭州影剧院

苏州海亮唐宁府

上海滨江凯旋门

常州天宁法院

上海欧尚广场

杭州临安车贸公司

上海虹桥国际机场

泉州国贸大厦

江苏泗阳成子湖

杭州通信中心

厦门太古机场

上海东方医院

徐州一中体育馆

杭州临安外贸公司

晋江燃气发电厂

江苏淮安自行车城

上海绿地集团

上海地铁一号线

南京国际服务外包产业园

无锡朗诗

