



Professional Poultry Equipments Manufacturer



Company Profile:

Shandong Goldenest Machinery Manufacturing Co.,Ltd is the earliest enterprise which engaged in the design, research, and manufacture of the automatic farming equipment for poultry and livestock since 1987. By now, Goldenest has accumulated about 30 year's experience in technical innovation.

Goldenest cover area of 80000m², factory area 45000m², office and research building area 6000m², have 25 engineers, around 500 workers. Located at Sancheng Road No.261, Economic Development Zone, Qingdao Pingdu City, Shandong Province of China.

In 2000 year, Goldenest imported Germany patent feed auger technology and produce lines. Now, Goldenest is the only one professional Germany feed auger manufacturer in China.

Goldenest has about 30 patent design and technology in total, like breeder metering cylinder feeding system, breeder plastic chain-plate open trough feeding system, automatic egg nest system, broiler pan feeder, pig chain feeding system etc.,

Goldenest have exported integrated equipment to many countries and areas, like East Southeast Asia, Middle East, South America, India, Australia, US and Canada.

Based on our customer's requirements and layout, Goldenest could supply complete automatic poultry and pig farming equipment as a turnkey project.

Our company sincerely invite you come to visit our factory, to learn with each other and make long-term business cooperation.





金巢机械
GOLDENEST

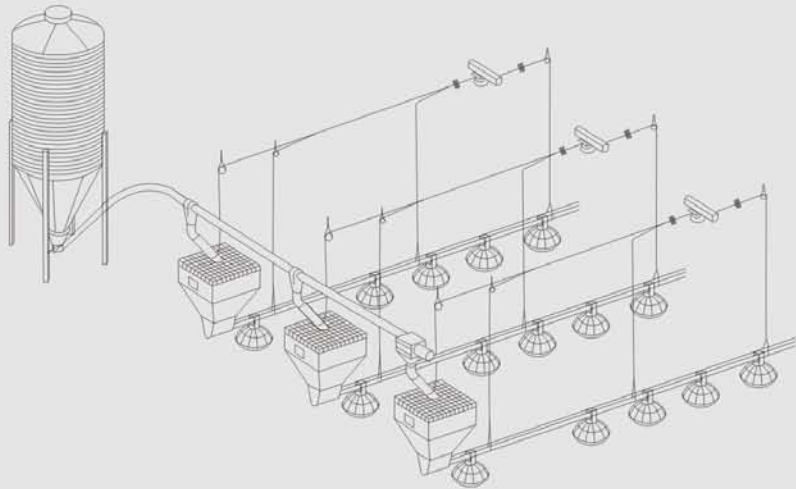

Poultry Feeding System

Layout for standard poultry control house

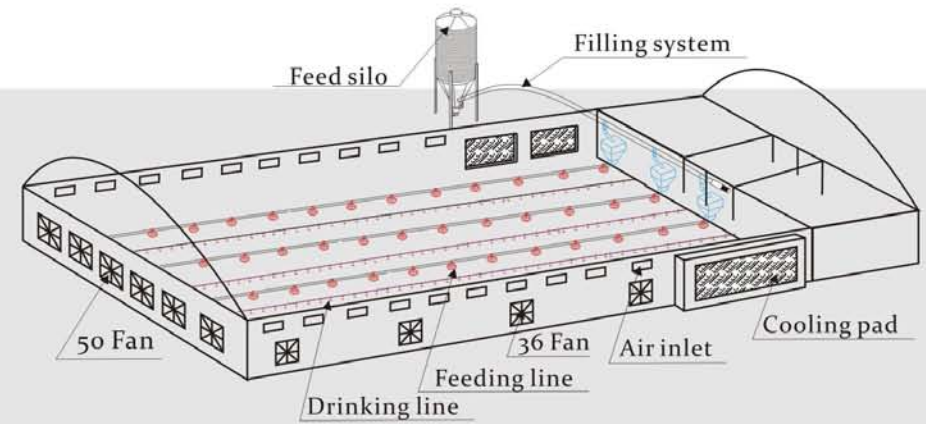

Filling System



Drawing for main filling system:
two ways, feed silo filling system or feed pit hopper filling system.

Galvanized Feed Silo

1. Capacity from 2Ton to 22Ton, satisfy different size poultry house.
2. Galvanized weight reach 275g/m², overall hot dip galvanized, anti-corrosion, antioxidant, acidoresistance, keep 15 years life outdoor using.
3. Optimized feed conversion, keeping feed fresh, reduce feed waste .
4. Patent sealed lid guard, prevent rain and snow flow into the silo.



Galvanized silo technical specification

Capacity (Ton)	Diameter (m)	Height (m)	Legs (pc)	Plate Thickness(mm) Vertebral / Cylindrical
2	1.83	3.6	4	1mm / 0.9mm
3-5	1.83	4.5	4	1mm / 0.9mm
4-6	1.83	5.4	4	1mm / 0.9mm
8	2.8	4.5	6	1mm / 0.9mm
10	2.8	5.4	6	1mm / 0.9mm
12	2.8	6.3	6	1mm / 0.9mm
14-15	2.8	7.1	6	1mm / 0.9mm
14-15	3.68	6.1	8	1.2mm / 1.2mm
17-18	3.68	6.4	8	1.2mm / 1.2mm
21-22	3.68	7.27	8	1.2mm / 1.2mm

Fiberglass Feed Silo & Feed Pit Hopper



Made by Fiberglass
Capacity have
2.5Ton, 3Ton, 5Ton, 7Ton, 10Ton

Made by hot galvanized steel
Capacity have
100kg; 200kg; 400kg; 800kg; 1.5Ton
The unloader has variety of angles
from 30 to 180, could adjust flexible
according your request, easy to install.



PVC tube & Feed Auger for main filling line



PVC tube : Unique formula, non-toxic, wear-resisting and durable.



Feed auger :
Germany patent technology and produce line
Wire material import from Japanese
Made by carbon steel, no welding sport
The Only professional feed auger manufacturer in China

Standard specification

90mm PVC tube with 70mm Feed auger or 75mm PVC tube with 60mm Feed auger

Feed Silo accessories



drive motor with reducer & adapter



single & double feed boot



weight scale system



feed loading truck



Broiler pan feeding system



Broiler Pan Feeder

Goldenest fourth generation broiler pan feeder.

National Patented No.: 200920162649.8 and 200920161606.8

The material: Copolymerization PP (engineering plastics), low fat soluble, plus our self patent nostrum, to keep best tenacity and uvioresistant.

The Color : red with white

The specification : 14 grids , 15 grids , 5 grids & flat bottom or wave bottom

The advantage :

- 1.Variety of feeding level,keep feed uniform and sufficient.
- 2.Pan edge height is suitable for all ages broilers, start from one day chick.
- 3.Control feed waste as deep pan bottom; easy feed as shallow pan edge.
- 4.Flat bottom and wave bottom design, for different client and market.
- 5.Patented unique locking mode, keep it easy to install and clean.
 - (1). Top seal is patented design;
 - (2). Fasten part is patented, combining the pan bottom and grids firmly.



45mm feed pipe & 36mm feed auger



The feed pipe is 3meter/set & the feeder distance could 0.75meter or 1 meter

We can make the feed auger according to your request size.

We can produce more than 50 kinds specification, 30 kinds cross section ,import Germany patent technology and produce line,wire material import from Japanese





Breeder metering cylinder feeding line (patented)

patent No. : ZL200430046925. 7
 Patent No. : ZL200420051815.4



- 1. Accurately metering feed level
- 2. Feed automatic drop to bottom pan synchronously
- 3. Limiting feed and saving feed



low feed level



middle feed level



high feed level

accurately metering



Install feeding control grid

Adjustable grid provide male eating female's feed



when the automatic feed release unit work, lifting all feeder's black ball up, all feed drop at the time

synchronously feed

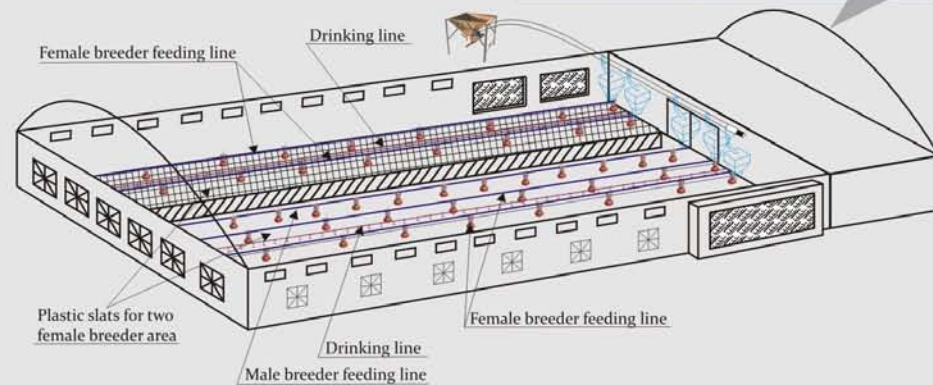



Breeder Chain -Disc Circle Pan feeding system



- ① The corner adopts high-intensity industrial plastic material which is advantageous in the property of high-stringency, no-noise, anti-corrosion and wearing-resistant especially in the harsh environment.
- ② The motor drive apply for the mould forming with 304 stainless steel. Also it transmits in the vertical direction and a gear reducer kicks in while slows down.
- ③ The installation case of poultry house with chain-disc pan feeding system.



- ④ The picture shows the electric lift drive motor which is in charge of hoisting or descending all the pan feeders and other parts in the chain-disc pan feeding system.
- ⑤ There is a need to put a main feed hopper in the feeding room which shall accommodate all the weighting feed, and then all the feed will be distributed to feed bin.



The flexible snap joint of feed grill opening

- Technical Date:
 - ① The diameter of the feeder pan is 360mm
 - ② With 16 spokes, 16 levels of feed adjust switch
 - ③ Design 3 levels of drop-point switch insert to feed according to different day old .
 - ④ The height of feed adjustable grill opening : 50mm , 60mm , 72mm , the width have 6 levels from 40mm to 50mm , suit for different day old
- The flexible snap joint is our company patent design, it's easy to adjust feed grill opening's size, high efficiency , could save labor largely.

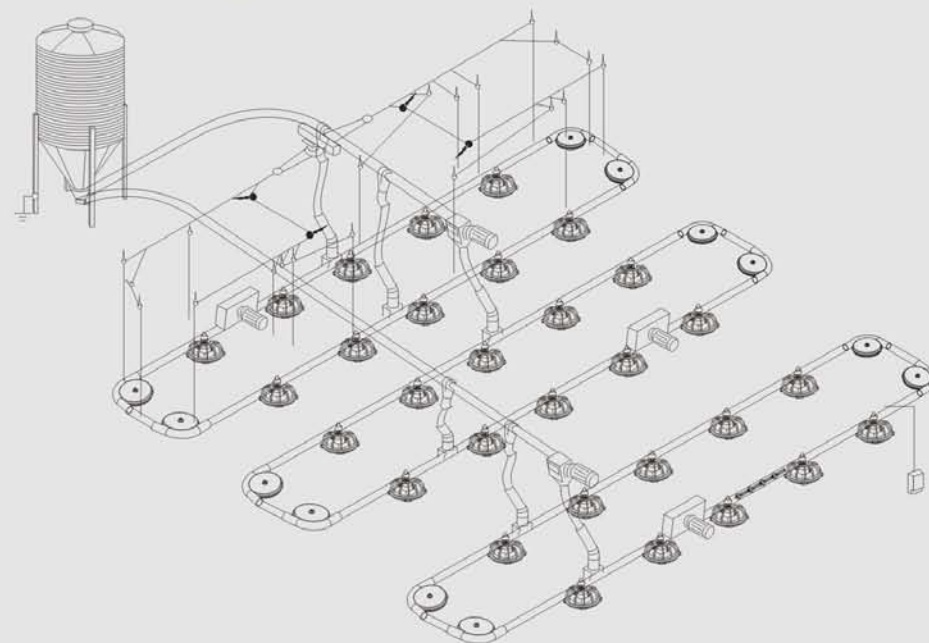

The layout for 3 circle chain-disc pan feeding system





Breeder chain-plate open trough feeding system



The plastic chain-plate open trough is our patent design and technology

- ① overall hot dip galvanized, anti-corrosion, antioxidant
- ② feed transport speed 0.75-1.5kg/meter chain-plate speed 36meter/min, insure feed uniformly and synchronous for all birds



Stainless steel drive motor



Corner conveyor

- ③ Motor design automatic failure alarm and shut down, avoid parts damaged
- ④ Corner design maintenance-free bearing, insure secure in operation



Feed bin



Plastic Chain-plate (patent)

- ⑤ Feed bin design high-efficiency feed drop unit, the size could custom-made
- ⑥ Made by PP (engineering plastics) no damage the trough, less noise, long using life



two option to choose



plastic chain-plate



metal chain-plate

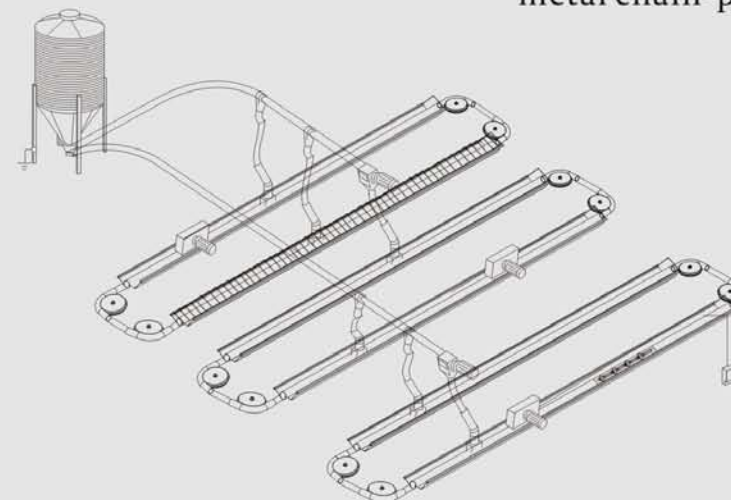

layout for 3 circle chain-plate open trough feeding system





Nipple Drinking System

Front component

- Front part is the controlling part of drinking system, it controls the water pressure and metering water quantity.
- Water regulator: ensure the balance of water pressure when in high or low water pressure, the recoil device is used to discharge the impurity in the water.
- Filter: ensure the cleanness of water.
- Water metering: convenient to meter the quantity of water .



Drinking line system

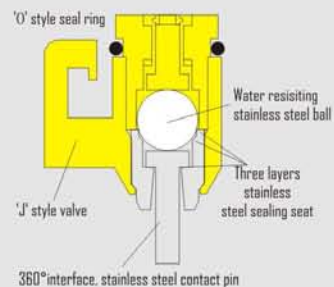
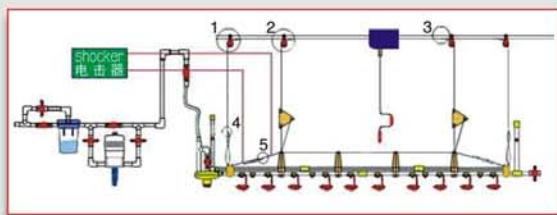

Figures of nipple drinker:

- 360° triggered, fits for all ages of birds as well as the chicks which born only one day.
- Stainless steel parts, ensure high quality.
- New style of flow controlling parts solved the corrosion and wet dung such kind of problems.
- Every nipple drinker can sufficiently supplies 15 broilers, 12 breeders or 10 ducks.
- Drinker fixed on drinking line by a connect part without use screw.
- All drinkers are inspected seriously before they can selling, ensure 100% high quality.
- Drinkers can be self clean.

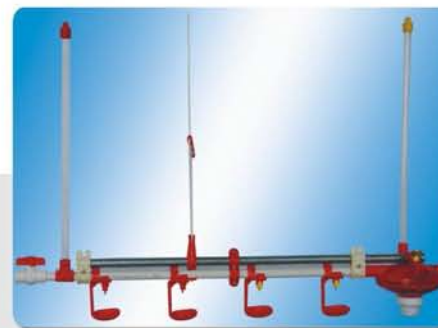

Figure for ending parts of drinking line:

The reading tube which is at the end of drinking line are made of transparent jaffaite, can be read easily. Levels of drinking line:

Age of bird/Day	1-7	8-14	> 15
Height on reading tube/mm	50-80	80-200	200-350

You can up adjust the metering height 30-50 mm for larger demand in summer.



Advantage: all of the metal parts are hot galvanized. And all the plastic parts are made of purify raw material, can ensure long life span. Nipple and water regulator both are high tech with stable performance, chicks can drink very well.



Egg nest system

Automatic egg nest system



- Double side type

Set the automatic open & close time
automatic collect egg save labor
reduce egg broken dirty rate



drive the bottom up and down



- Single side type



egg collection table

24 hole manual egg nest



- Made by hot galvanized steel
- Independent room, avoid hen across each other
- Nest's frame design air hole, insure nest well ventilation

Egg nest pad

- The size:
250*300mm & 250*370mm
- The material:
100% raw PP, patent recipe
- Soft and comfortable, reduce breeder egg broken
- Reasonable bottom hole size more excellent manure leakage and ventilation performance

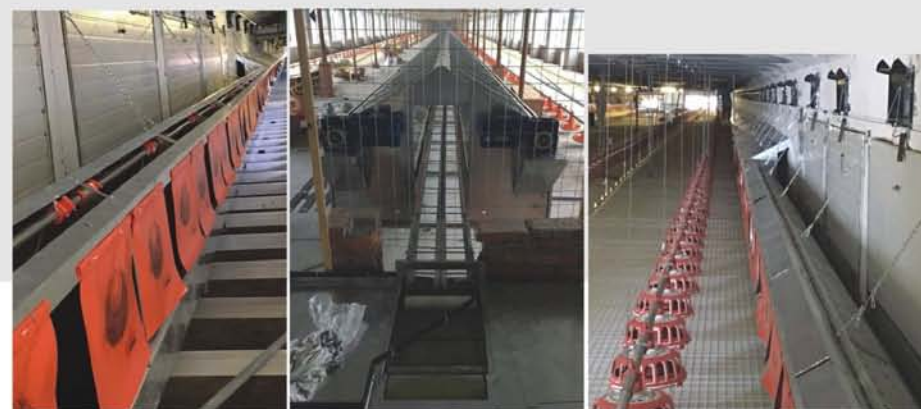
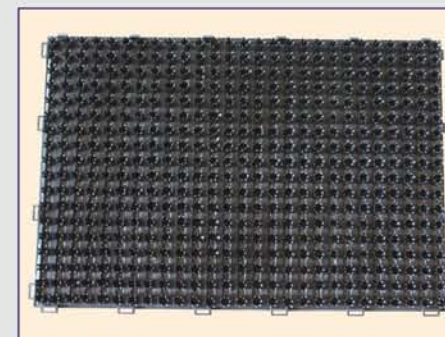

Project in breeder house



Plastic slats for poultry

Poultry slats

- ① 1020*600mm big hole
- ② 1020*600mm small hole
- ③ 1200*500mm oblong hole
1000*500mm oblong hole



Big square hole plastic slat	1020mm*600mm*40mm / 2.2kg / hole size:25mm*20mm
Small square hole plastic slat	1020mm*600mm*40mm / 2.38kg / hole size:8mm*6mm
Oblong hole plastic slat	1200mm*500mm*40mm / 2.3kg / hole size:40*18mm
Oblong hole plastic slat	1000mm*500mm*40mm / 1.91kg / hole size:40*18mm
Triangle beam (8cm height)	made by PVC 1kg/meter
Triangle beam (12cm height)	made by PVC 1.55kg/meter
Support leg (type B)	Height freewill as middle PVC pipe length custom-made
Support leg (type A)	Adjust height from 18cm to 28cm



height:8cm & 12cm

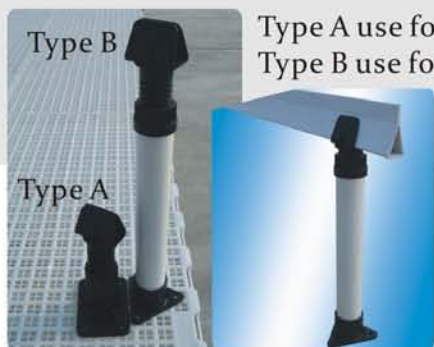

Type A use for broiler
Type B use for breeder



Detail of the plastic slats

1. The Material : Engineering polypropylene , 100% raw material.
Plus patent recipe, to keep plastic modification, keep anti-oxidants, anti-inhibitor, anti-ultraviolet, corrosion resistance, high strength.
2. Made by modern molding, the slats finish in one-time.
3. The plastic slat's bearing around 250kg.
4. Good leakage dung rate as the rational hole design, and no burr on surface.
5. Easy to install and clean, connect one by one firmly.
6. Warranty of 15-20 years using life.



Loading-bearing:
load 4 people at the same time without any sagging.





Manure cleaning scraper



Heavy duty gearwheel drive motor
normally, one motor drives 2 or 3 scraping boards, the cleaning efficiency can reach as high as 95%.



Heavy duty scraping board



Large diameter corner wheel

Promote the life span of the driving rope, double bearing, with rope-off-prevent device.

High strength chemical fiber rope

Specifications: $\Phi 16$, $\Phi 18$, $\Phi 20$, etc.



Manure high-temperature aerobic fermentation reactor



Our company began importing and digesting foreign advanced technology, research and develop "livestock and poultry manure high-temperature aerobic fermentation reactor", Reactor material: 304 stainless steel, strong hydraulic driven, continuous fermentation oxygenation, a year four season run. Mainly for livestock and poultry farms, every day to collect fresh manure and in situ to fermentation treatment.



Need to decrease the unfermented manure's moisture by adding dry material, to control the moisture below 65%; just in a week, the reactor can produce of fermented thoroughly, completely decomposed, containing water in 20% - 30%, organic fertilizer

Using multilayer insulation treatment, insure reactor's temperature always between 65-85 degrees Celsius, can effectively kill a variety of eggs and pathogenic bacteria.

Because of the fermentation process under a sealed condition, could collect waste gas and odor to centralized processing, discharged clean gas into the atmosphere; achieve discharge standards, prevent secondary pollution.

The fermentation reactor can reduce the amount of capital investment, low energy consumption, small occupied area, high degree of automation, one person can operate several set fermentation equipment, the production cost is relatively low, investment income is relatively ideal.



The Technical Specification

Specification / Model	GFJ-70	GFJ-90	GFJ-120
Fermentation reactor capacity	70m ³	90m ³	120m ³
Manure lifting hopper capacity	0.7m ³	0.7m ³	0.9m ³
Vortex force fan A	7.5KW	7.5KW	16.5KW
Vortex force fan B	12.5KW	12.5KW	12.5KW
Hydraulic pressure station	7.5KW	22KW	30KW
The motor of manure lifting hopper	2.2KW	2.2KW	2.2KW
Filling Switch motor	0.55KW	0.55KW	0.55KW
Induced draft fan	3KW	3KW	5KW
Heating system (optional)	3KW	3KW	5KW
Gas treatment	High strength optical pyrolysis		
lubrication	Centralization lubrication		
Equipment total weight	22T	28T	35T
Manure input quantity (the manure's moisture below 65%)	7-8m ³	10-11m ³	12-13m ³
Organic fertilizer output quantity	3m ³	4m ³	5m ³

The specific parameters will be subject to actual situation

The Technical Process

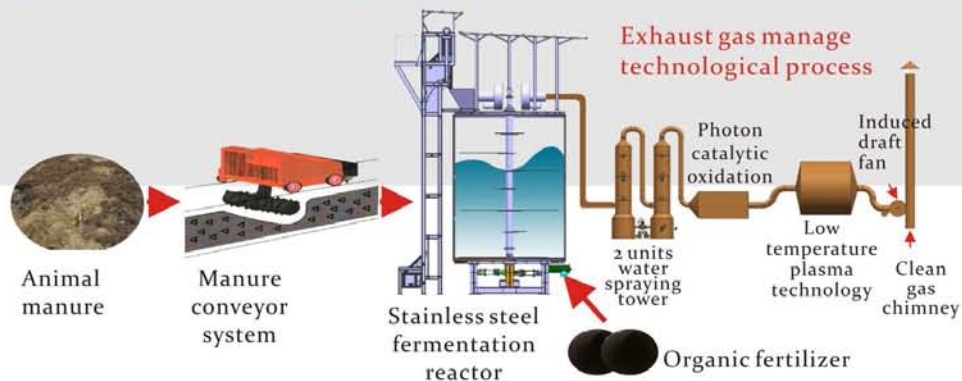

Input manure



Output manure



- ← Clean gas chimney
- ← 2 units water spraying tower
- ← Fermentation reactor
- ← Photon catalytic oxidation
- ← Low temperature plasma
- ← Induced draft fan



Ventilation Fan

Hammer fan



Model Type	Dia of blade	RPM of blade	RPM of motor	Capacity	Pa	Noise	Input power (w)	Rated voltage (v)	Height	Width	Thic-kness
830型	710	660	1400	20000	60	≤60	550	380	830	830	400
1000型	900	610	1400	25000	70	≤70	750	380	1000	1000	400
1380型	1250	439	1400	44000	56	≤70	1100	380	1380	1380	400
1530型	1400	325	1400	55800	60	≤70	1500	380	1530	1530	400

- Stainless steel blades, corrosion resistant, long life span.
- Belt are good tension and make the wind supplying constant and stable.
- Heavy duty aluminum-magnesium alloy strap wheel, strengthened and durable.
- Imported bearing with reliable performance.

Centrifugal box fan

- Opening unit is made from advanced nylon, high strength and long service life.
- Turning unit with bearing makes the opening process smarter.
- When fan starts work, the windows are opened quickly under the centrifugal force.

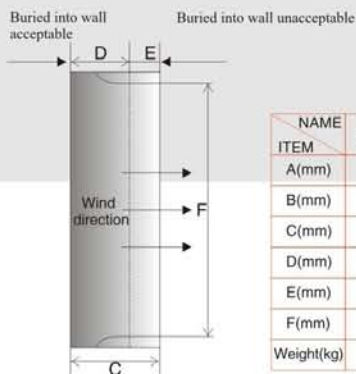
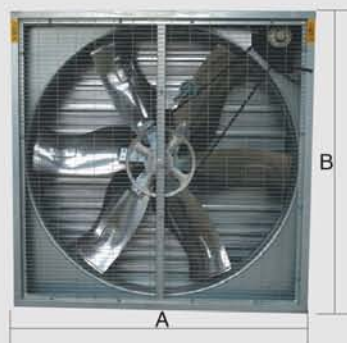

NAME	36" Fan	50" Fan
A(mm)	1000	1380
B(mm)	1000	1380
C(mm)	450	450
D(mm)	305	305
E(mm)	145	145
F(mm)	910	1290
Weight(kg)	65	88

ITEM	Technique parameter	
	NAME	Technique parameter
		50 Fan 36 Fan
Diameter blades	mm	1270 910
RPM of blades	r/min	437 438
Voltage	V	380 380
Current	A	2.8 1.2
Power	Kw	1.1 0.4
RPM of motor	r/min	1400 1400
Capacity	M3/h	43080 20800
Noise	dB	≤65 ≤64

Centrifugal butterfly cone fan

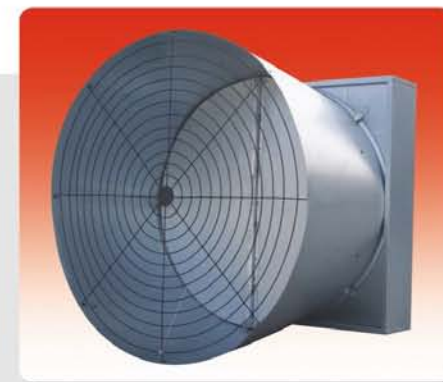

Butterfly cone fan is developed from standard 50" cone fan, with more powerful ventilation speed and higher negative pressure in the poultry or livestock house.

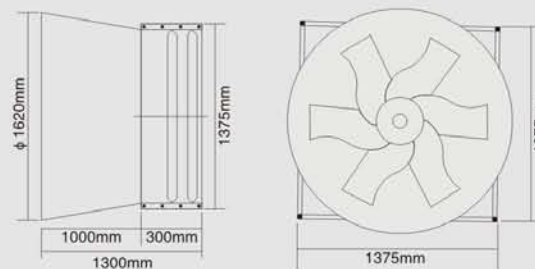

Model	50/0.75	50/1.1
Capacity (m³/h)	44000	49500
Noise (dBA)	64	65
Weight (kg)	110	112
Diameter of blades (mm)	1270	1270
Rated voltage (v)	380	380
Rated power (kw)	0.75	1.1
PRM of blades (n/min)	450	450





Cooling Pad

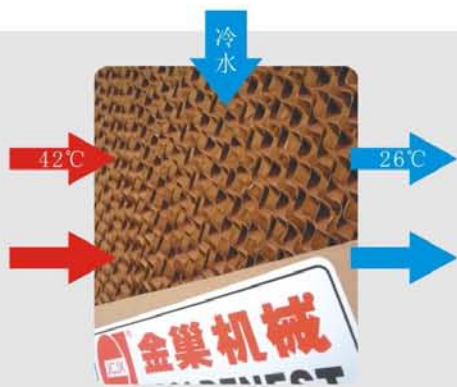

- Use the new material and the space crossing linking technology, high absorbability, high water-resistant, anti-mildew and long service life.
- The product contains surface active agent, natural water absorbability, fast pervasion speed, lasting effectiveness. A drop of water can diffuse in 4-5 seconds. Height of absorb: 60-70mm/5 minutes, 200mm/1.5 hours, can achieve international standard.
- Strict production as per standard, width of 600mm cooling pad involves 85 sheets; raw material adopt imported kraft paper (100g/sqm, thickness: 0.18-0.20mm, tension resistance at 70N, absorbability height as 45mm/10min, moisture at 5-8%, humidity at 18N)

- Products don't contain phenol which easy to skin allergy and other chemical substances, when installed non-toxic harmless to human body, safety, energy saving, environmental protection and economic applicable.

Specification of cooling pad paper

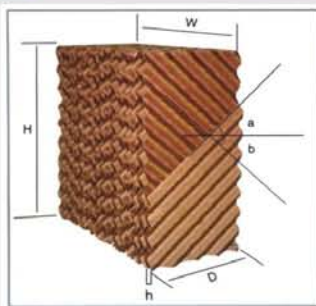

	7090型(model)	7060型(model)	5090型(model)
H(mm)	1500.1800.2000	1500.1800.2000	根据客户要求定做 Custom-made by client's requirements
W(mm)	900.600.300	900.600.300	根据客户要求定做 Custom-made by client's requirements
T(mm)	100.150.200	100.150.200	根据客户要求定做 Custom-made by client's requirements
h(mm)	7	7	5
a(°)	45	45	45
b(°)	45	15	45

- H: 湿帘高度 Height of pad
- h: 湿帘波纹高度 height of flute
- a: 波纹角度 Angle of flute
- W: 湿帘宽度 Width of pad
- D: 湿帘厚度 Thickness of pad
- b: 波纹角度 Angle of flute



- 棕色湿帘 Brown colour
- 绿色湿帘 Green colour
- 双色湿帘 Green/Brown colour
- 单面黑色湿帘 (可清洗) One side black-coated (washable)
- 单面绿色湿帘 (可清洗) One side green-coated (washable)
- 单面黄色湿帘 (可清洗) One side yellow-coated (washable)

Cooling system: Water go through the pipe under the pressure of pump and enter the paper, then forms water spray, when the dry and hot air go through the cooling pad under the pressure of fans, the heat in the air left by the cool water in the cooling pad, in this way, reach the cooling purposes.



组装好镀锌板外框湿帘
Assembled cooling pad with GS frame



组装好不锈钢外框湿帘
Assembled cooling pad with SS frame

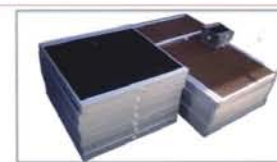

组装好铝合金外框湿帘
Assembled cooling pad with AL frame



Installation diagram

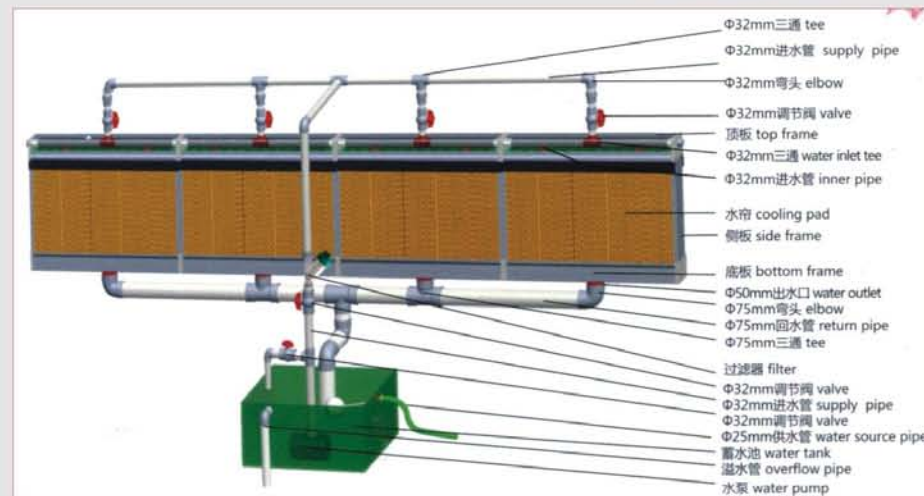

Engineering Projects



Air Inlets Window



Size: 270*560mm

Inlet window:
100% raw PP, design reasonable, good seal.
switch system:
manual winch & automatic drive motor
ununiformly control open angle, insure
no dead corner.

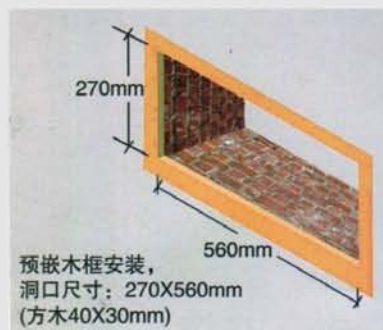

Air-inlet control equipment

- Automatic control:
Operated by the negative pressure controller until negative pressure reach to the set level.
- Manual control:
Operated by farm worker to adjust the negative pressure of the farm until the negative pressure reach to the set level.



High-pressure Spraying



The working state of sprayer

Movable pump station, using high-pressure plunger pump with 10-70kg/cm outlet pressure, and 70-125L/min flow rate.

Normally one movable pump station can used for one house or 2 house.

Basic parameter of spray system

SIZE	DRIFCE DIA. MM	PRESSURE	FLOW
No.1	0.10mm-0.15mm	10-70kg/cm	20-46cc/min
No.2	0.20mm	10-70kg/cm	49-89cc/min
No.3	0.30mm	10-70kg/cm	80-145cc/min
No.4	0.40mm	10-70kg/cm	95-178cc/min
No.5	0.50mm	10-70kg/cm	130-243cc/min



Pipes of high-pressure and accessories all stainless, can stand 0-70kg pressure.



Environment Controller

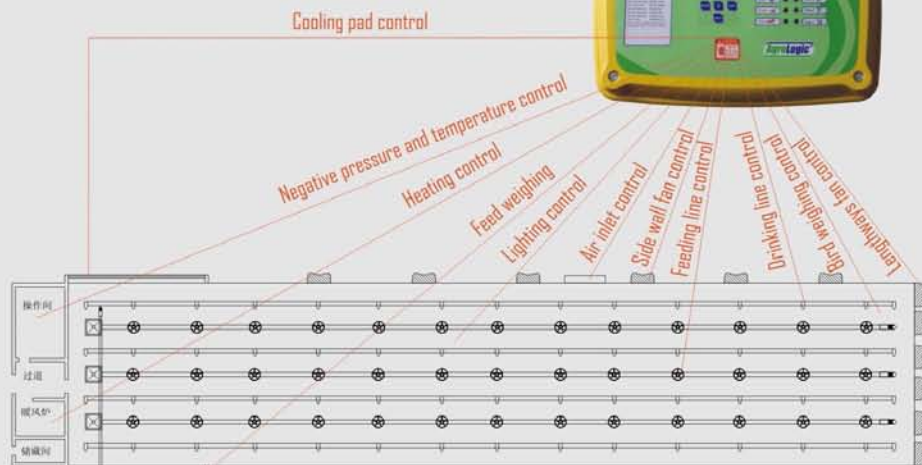

The environment controller (T607/T610/T616) is imported from Israel, the controllers are world leading level in the inner environment controlling field.



Other Environment Control System



Light trap



Side wall curtain



LED light line



Kinds of heater

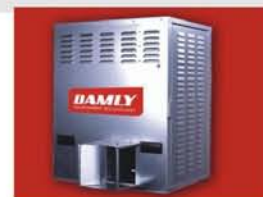



Poultry manual feeder & drinker

Standard Manual feeder



1. Made by 100% raw material ;
2. Plus recipe to keep plastic modification, anti-oxidants, anti-inhibitor, corrosion resistance, high-duty.
3. Kinds of size and capacity.

High quality manual feeder



Manual drinker



Chick feed tray



Bell drinker



Poultry crates & egg tray

Chick crates



Adult chicken crates

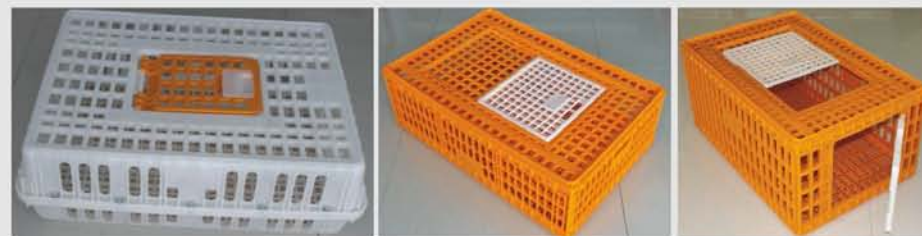

Egg tray



Egg tray





Geese and ducks feeding system

Tube Feeding system

Pan Feeding line



Pan feeding line



Feeder pan for geese and ducks



Raw material duck manual feeder
 Color : yellow or white
 Capacity: 5kg、20kg、40kg
 Size: 190×290×280
 320×300×550
 500×650×670



Silo and filling system



Application of duck equipment Vertical conveying pipeline to achieve two-way feed

Application of duck equipment Vertical conveying pipe for one side feed



Duck second-hand material manual feeder

Capacity:20kg\40kg;
 Size:300*300*500\500*550*660

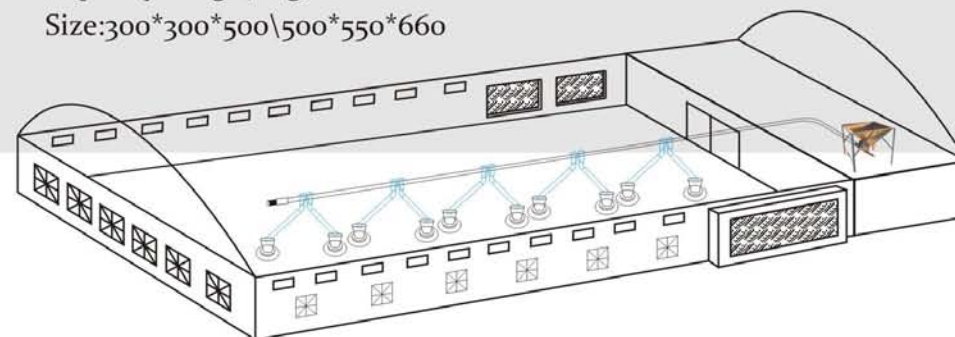

In the exhibition

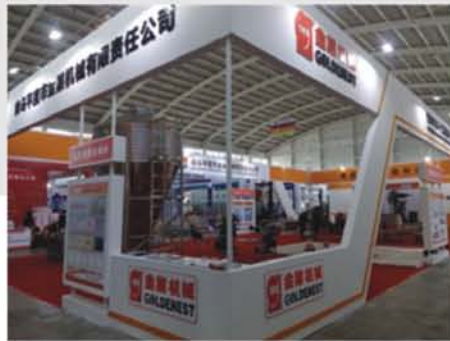

The workshop



The certificate



Shandong Goldenest Machinery Manufacturing Co., Ltd

ADD: SanCheng No. 261, Economic Development Zone, Qingdao Pingdu City, ShanDong, CHINA.

TEL: +86 532 84356168 FAX: +86 532 8832 6688 WEB: goldenestmachine.en.alibaba.com

Oversea Department Email: maotong@goldenestchina.com