

Hebei Zhonghaolian Import and Export Trade Co., Ltd.
河北众浩联进出口贸易有限公司

Products Catalogue
for
AUTO JACK

<http://hbzhonghaolian.en.alibaba.com>

TEL/Wecaht/Whatsapp: 0086-13398646742

lily.liu@zhonghaolian.com

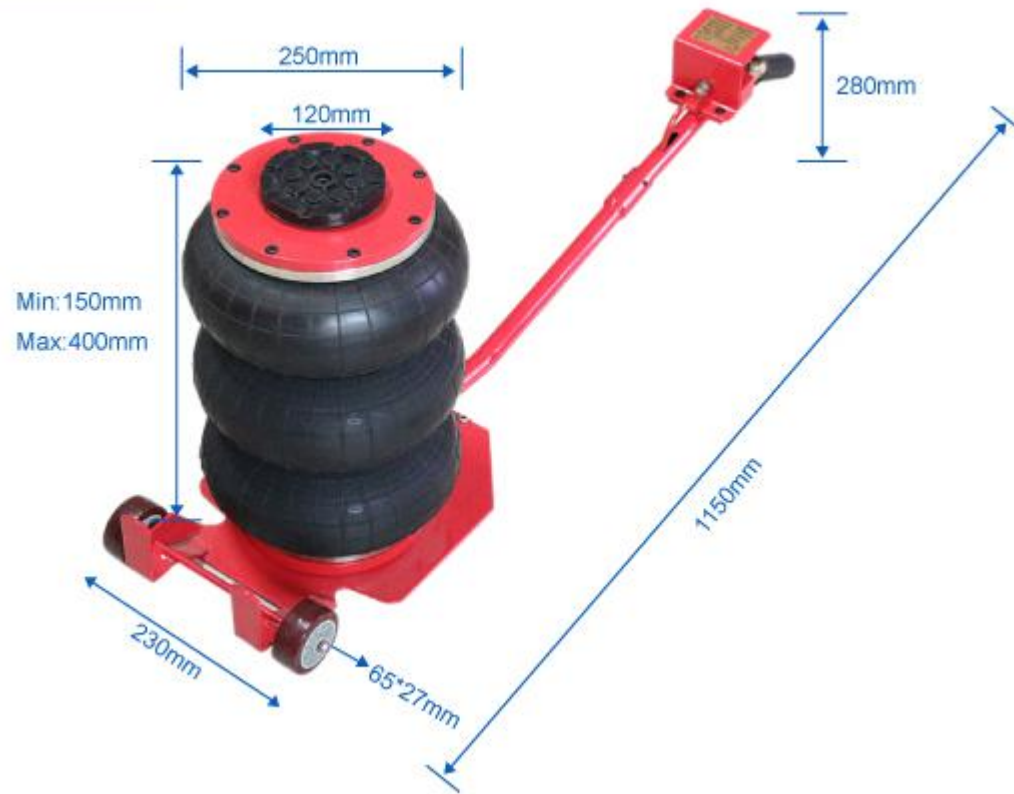

Model	Capacity	Min Height	Max Height	Dia of Bag	N/G Weight
HR-3A	3 Ton	150MM	400MM	250MM	19/20kg



Model	Capacity	Min Height	Max Height	Dia of Bag	N/G Weight
HR-3B	3 Ton	150MM	400MM	250MM	19/20kg



Model	Capacity	Min Height	Max Height	Dia of Bag	N/G Weight
HR-3F	3 Ton	150MM	400MM	250MM	16/17kg

AIR BAG JACK



Model	Capacity	Min Height	Max Height	Dia of Bag	N/G Weight
HR-3D	3 Ton	150MM	400MM	250MM	19/20kg



Model	Capacity	Min Height	Max Height	Dia of Bag	N/G Weight
HR-2B	3 Ton	110MM	300MM	250MM	18/19kg



Model	Capacity	Min Height	Max Height	Dia of Bag	N/G Weight
HR-5T	5 Ton	150MM	400MM	330MM	26.5/28kg

3T 3吨卧式油压千斤顶 3TON Hydraulic Floor Jack



型号	MODEL	OKD-1
起重	CAPACITY	3TON
最低高度	MIN.HEIGHT	120MM
最高高度	MAX.HEIGHT	512MM
毛/净重	G./N.WEIGHT	30/28KGS
包装尺寸	PACKAGE SIZE	695x375x210MM



3T 3吨双泵卧式油压千斤顶 3TON Double Pump Hydraulic Floor Jack



型号	MODEL	OKD-3
起重	CAPACITY	3TON
最低高度	MIN.HEIGHT	127MM
最高高度	MAX.HEIGHT	460MM
毛/净重	G./N.WEIGHT	33/31 KGS
包装尺寸	PACKAGE SIZE	650x375x210MM



3T

3吨双泵超低位卧式油压千斤顶
3TON Double Pump Low Down Hydraulic Floor Jack

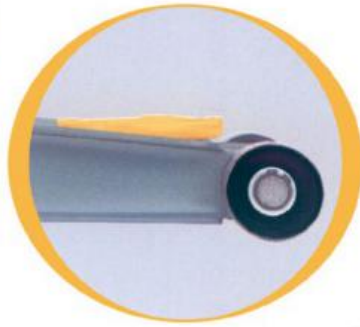

型号	MODEL	OKD-4
起重	CAPACITY	3TON
最低高度	MIN.HEIGHT	75MM
最高高度	MAX.HEIGHT	505MM
毛/净重	G./N.WEIGHT	36/34KGS
包装尺寸	PACKAGE SIZE	725x375x210MM

FAST 双泵超低位

2T

2吨迷你型卧式油压千斤顶
2TON Mini Hydraulic Floor Jack



型号	MODEL	OKD-9
起重	CAPACITY	2TON
最低高度	MIN.HEIGHT	140MM
最高高度	MAX.HEIGHT	389MM
毛/净重	G./N.WEIGHT	12/11KGS
包装尺寸	PACKAGE SIZE	390x220x190MM

JP35T-1气动液压千斤顶

Pneumatic Hydraulic Jack

起重量	35T	Capacity	35T
使用气压	0.8-1.2Mpa	Air pressure	0.8-1.2Mpa
最低高度	195mm	Minimum height	195mm
起升高度	300mm	Lift	300mm
加长顶	40mm 75mm	Extension height	40mm 75mm
工作压力	31.2Mpa	Rated pressure	31.2Mpa
净重	31kg	Net weight	31kg

JP50T-1气动液压千斤顶

Pneumatic Hydraulic Jack

起重量	50T	Capacity	50T
使用气压	0.8-1.2Mpa	Air pressure	0.8-1.2Mpa
最低高度	195mm	Minimum height	195mm
起升高度	310mm	Lift	310mm
加长顶	40mm 75mm	Extension height	40mm 75mm
工作压力	31.2Mpa	Rated pressure	31.2Mpa
净重	52kg	Net weight	52kg

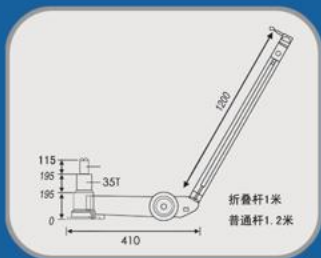

JP50T-2气动液压千斤顶

Pneumatic Hydraulic Jack

起重量	50/25T	Capacity	50/25T
使用气压	0.8-1.2Mpa	Air pressure	0.8-1.2Mpa
最低高度	165mm	Minimum height	165mm
起升高度	330mm	Lift	330mm
加长顶	40mm 75mm	Extension height	40mm 75mm
工作压力	31.2Mpa	Rated pressure	31.2Mpa
净重	48kg	Net weight	48kg

JP50T-2气动液压千斤顶

Pneumatic Hydraulic Jack

起重量	50/25T	Capacity	50/25T
使用气压	0.8-1.2Mpa	Air pressure	0.8-1.2Mpa
最低高度	195mm	Minimum height	195mm
起升高度	420mm	Lift	420mm
加长顶	40mm 75mm	Extension height	40mm 75mm
工作压力	31.2Mpa	Rated pressure	31.2Mpa
净重	52kg	Net weight	52kg

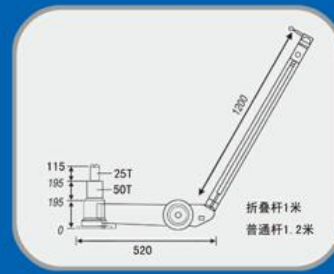
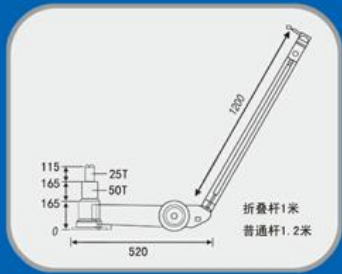

JP80T-2气动液压千斤顶

Pneumatic Hydraulic Jack

起重量 80/40T	Capacity	80/40T
使用气压 0.8-1.2Mpa	Air pressure	0.8-1.2Mpa
最低高度 195mm	Minimum height	195mm
起升高度 370mm	Lift	370mm
加长顶 40mm 75mm	Extension height	40mm 75mm
工作压力 31.2Mpa	Rated pressure	31.2Mpa
净重 62kg	Net weight	62kg

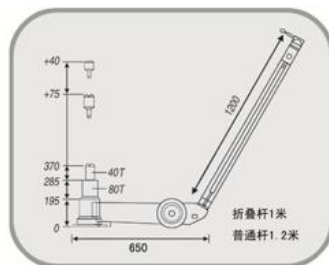

JP80T-2气动液压千斤顶

Pneumatic Hydraulic Jack

起重量 80/40T	Capacity	80/40T
使用气压 0.8-1.2Mpa	Air pressure	0.8-1.2Mpa
最低高度 195mm	Minimum height	195mm
起升高度 370mm	Lift	370mm
加长顶 40mm 75mm	Extension height	40mm 75mm
工作压力 31.2Mpa	Rated pressure	31.2Mpa
净重 75kg	Net weight	75kg

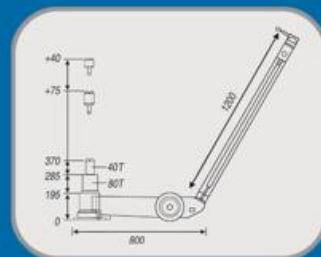

气动液压千斤顶*80T

JP80T-2气动液压千斤顶

Pneumatic Hydraulic Jack

起重量	80/40T	Capacity	80/40T
使用气压	0.8-1.2Mpa	Air pressure	0.8-1.2Mpa
最低高度	225mm	Minimum height	225mm
起升高度	460mm	Lift	460mm
加长顶	40mm 75mm	Extension height	40mm 75mm
工作压力	31.2Mpa	Rated pressure	31.2Mpa
净重	85kg	Net weight	85kg

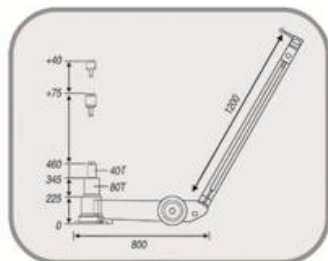

JP80T-2气动液压千斤顶

Pneumatic Hydraulic Jack

起重量	80/40T	Capacity	80/40T
使用气压	0.8-1.2Mpa	Air pressure	0.8-1.2Mpa
最低高度	210mm	Minimum height	210mm
起升高度	410mm	Lift	410mm
加长顶	40mm 75mm	Extension height	40mm 75mm
工作压力	31.2Mpa	Rated pressure	31.2Mpa
净重	80kg	Net weight	80kg

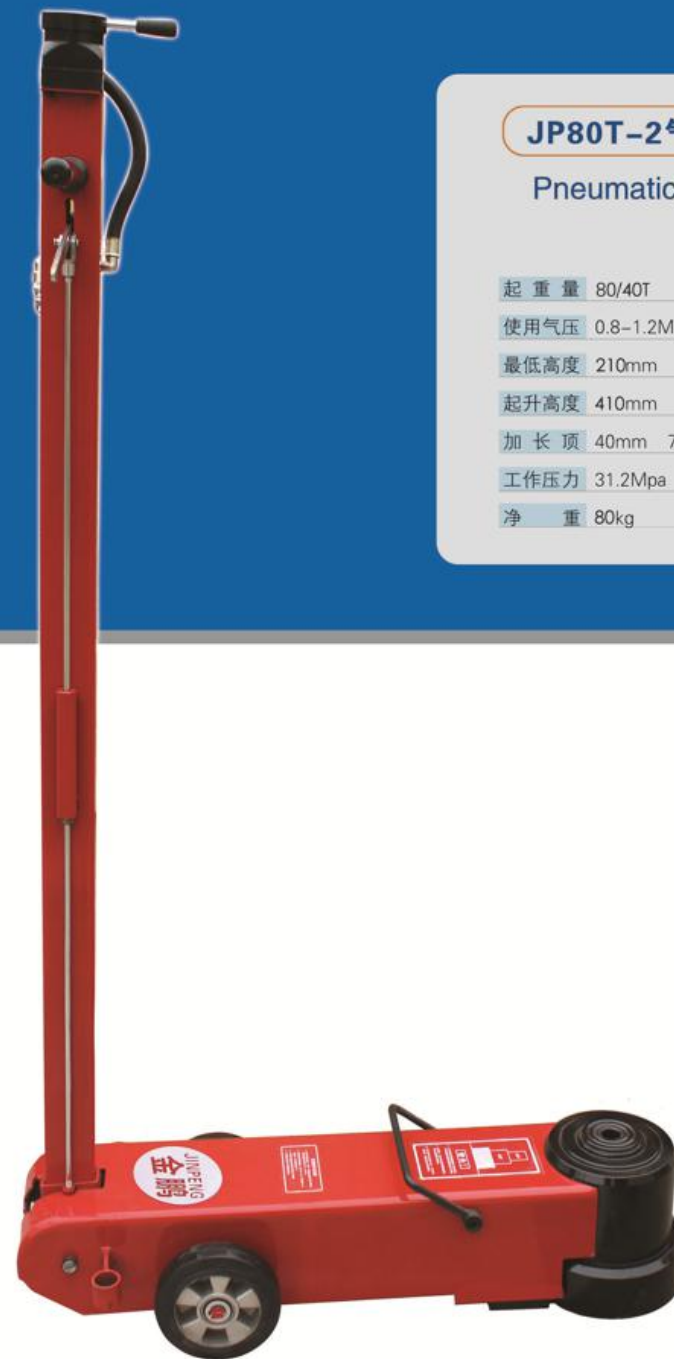

JP100T-2气动液压千斤顶

Pneumatic Hydraulic Jack

非标 Mistake bid

起重量	100/50T	Capacity	100/50T
使用气压	0.8-1.2Mpa	Air pressure	0.8-1.2Mpa
最低高度	195mm	Minimum height	195mm
起升高度	370mm	Lift	370mm
加长顶	40mm 75mm	Extension height	40mm 75mm
工作压力	31.2Mpa	Rated pressure	31.2Mpa
净重	85kg	Net weight	85kg



JP100T-2气动液压千斤顶

Pneumatic Hydraulic Jack

国标 The country is labeled with

起重量	100/50T	Capacity	100/50T
使用气压	0.8-1.2Mpa	Air pressure	0.8-1.2Mpa
最低高度	195mm	Minimum height	195mm
起升高度	370mm	Lift	370mm
加长顶	40mm 75mm	Extension height	40mm 75mm
工作压力	31.2Mpa	Rated pressure	31.2Mpa
净重	95kg	Net weight	95kg



JP100T-2气动液压千斤顶

Pneumatic Hydraulic Jack

非标 Mistake bid

起重量	100/50T	Capacity	100/50T
使用气压	0.8-1.2Mpa	Air pressure	0.8-1.2Mpa
最低高度	195mm	Minimum height	195mm
起升高度	370mm	Lift	370mm
加长顶	40mm 75mm	Extension height	40mm 75mm
工作压力	31.2Mpa	Rated pressure	31.2Mpa
净重	105kg	Net weight	105kg

JP100T-2气动液压千斤顶

Pneumatic Hydraulic Jack

国标 The country is labeled with

起重量	100/50T	Capacity	100/50T
使用气压	0.8-1.2Mpa	Air pressure	0.8-1.2Mpa
最低高度	195mm	Minimum height	195mm
起升高度	370mm	Lift	370mm
加长顶	40mm 75mm	Extension height	40mm 75mm
工作压力	31.2Mpa	Rated pressure	31.2Mpa
净重	115kg	Net weight	115kg

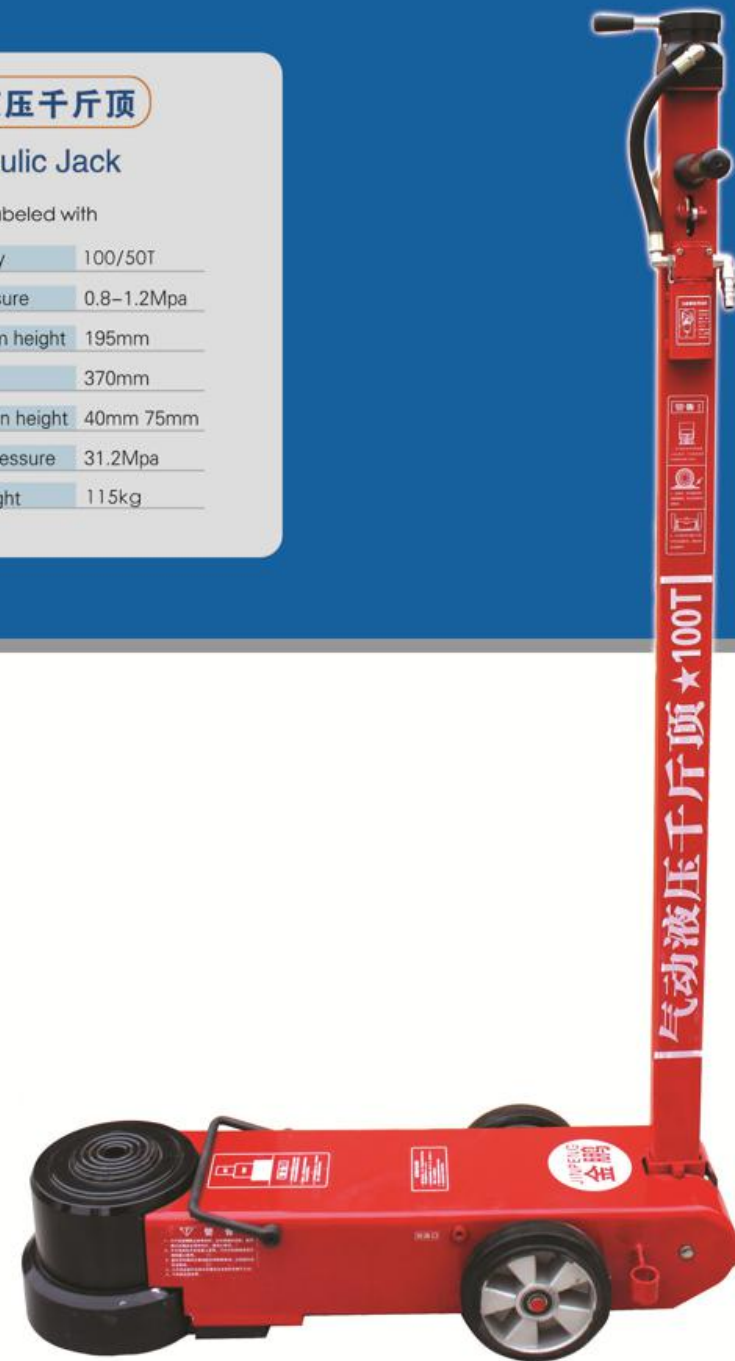
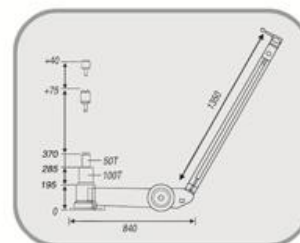
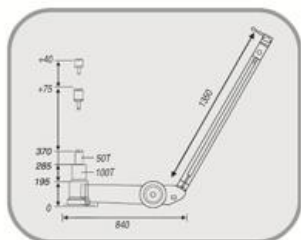

BOTTLE JACK



Model	Capacity (ton)	Min.H (mm)	Lifting.H. (mm)	Adjust.H. (mm)	Max.H. (mm)	N.W. (kg)	G.W. (kg)	Package	Qty/Ctn (pcs)	Measurement (cm)	20'Container (pcs)
SD0301	2	148	80	50	278	2.1	22	Color Box	10	52x22x15.8	10000
SD0302	3	158	90	50	298	2.3	24	Color Box	10	52x22.5x17	9160
SD0303	5	180	110	60	350	3.3	17.5	Color Box	5	58x13x19	6280
SD0304	8	185	110	60	355	3.6	19	Color Box	5	62x14x19.5	5780
SD0305	10	195	120	60	380	5	26	Color Box	5	63x14.5x20.5	4230
SD0306	12	200	125	60	385	5.5	23	Color Box	4	54x14.5x21	3820
SD0307	15 or 16	210	145	60	405	6.5	27	Color Box	4	58x15.5x22	3250
SD0308	20	235	135	60	430	8	17	Color Box	2	33x18x24.5	2580
SD0309	32	255	150	60	460	11.5	24	Color Box	2	34x18.5x26.5	1830
SD0310	32	255	150	/	405	10.8	22.6	Color Box	2	34x18.5x26.5	1940
SD0311	50	225	120	60	405	18.5	19.5	Carton	1	20.5x18x23.5	1120
SD0312	50	255	150	60	465	19.5	20.5	Carton	1	20.5x18x26.5	1070
SD0313	50	255	150	/	405	19	20	Carton	1	20.5x18x26.5	1100

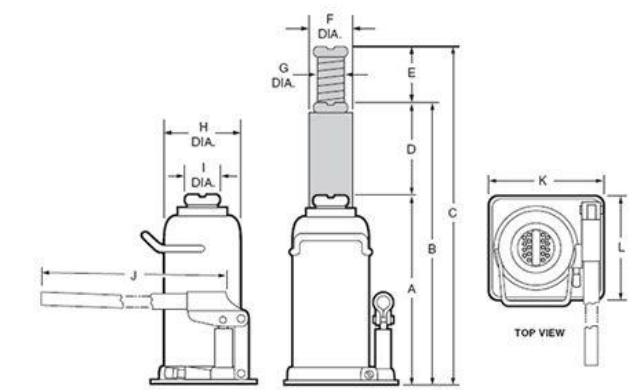

Model	A	B	C	D	E	F	G	H	I	J	K	L	N.W
2t	150	235	285	85	50	23	16	48	21	348	69	86	2.0
3t	170	285	335	115	50	23	16	48	21	348	70	88	2.2
4t	170	285	335	115	50	23	16	60	21	348	79	88	2.5
5t	170	280	335	110	55	28	19	60	21	355	79	91	2.9
6t	180	295	345	115	50	28	20	70	25	355	85	93	3.3
8t	180	300	360	120	60	32	24	70	30	500	87	104	3.9
10t	195	315	375	120	60	38	25	76	35	500	94	109	4.7
12t	195	320	385	125	60	40	28	80	36	500	104	116	5.2
16t	210	345	405	135	60	43	29	95	40	500	108	116	6.2
20t	225	380	440	155	60	48	32	107	43	595	122	144	8.6
32t	255	425	480	170	55	51	36	112	46	595	140	163	11.9
50t	245	390	/	145	/	85	/	158	84	600	210	172	25.9
100t	335	515	/	180	/	119	/	230	116	600	240	269	68

JACK STAND

2 Ton Jack Stand



3 Ton No Foot Pad



6 Ton No Foot Pad



3 Ton With Safety Pin



6 Ton With Safety Pin



12 Ton Jack Stand



2 Ton With Foot Pad



3 Ton With Foot Pad



6 Ton With Foot Pad



Robot Welding Straight and Nice Weld Seam



2 Ton Standard



3 Ton Standard



3 Ton Heavy Duty

Carton Size				
Spec	Packing	Qty/Ctn	Ctn Size	G. W. /N. W.
2 Ton	Color Box	6Box	62.5x38.5x36.5cm	28/27kg
3 Ton	Color Box	6Box	66x41.5x34.5cm	31/30kg
6 Ton	Color Box	3Box	77x31x44cm	31/30kg

Color Box Size	
Color Box for 2 Ton	20x1.85x35cm
Color Box for 3 Ton	21.5x20x33cm
Color Box for 6 Ton	29.5x25x42.5cm

Color Options: ● ● ● ● ●

JACK CATALOGUE

<http://hbzhonghaolian.en.alibaba.com>

TEL +8613398646742

lily.liu@zhonghaolian.com