



2018-B

**浙江康瑞器械科技股份有限公司**  
公司地址：浙江省绍兴市王坛工业园区  
电话：0575-85788062 85781458  
传真：0575-85783388  
邮编：312055  
网址：www.sxkd.com.cn  
邮箱：ked@sxkd.com.cn

**ZHEJIANG KANGRUI APPARATUS TECHNOLOGY CO.,LTD**  
Add : Wangtan Shaoxing P.R.China  
Tel : 86 575 85788062 85781458  
Fax : 86 575-85783388  
P.C : 312055  
http : //www.sxkd.com.cn  
E-mail : ked@sxkd.com.cn

**浙江康瑞器械科技股份有限公司**  
**ZHEJIANG KANGRUI APPARATUS TECHNOLOGY CO.,LTD**



## 公司简介

浙江康瑞器械科技股份有限公司（原绍兴康尔达器械有限公司）成立于1996年，系集“科、工、贸”于一体，专业生产畜牧兽医、畜牧养殖器械并拥有自营进出口权的股份制企业。公司旗下设有子公司绍兴康尔达进出口有限公司及浙江康瑞畜牧兽医器械研究院。

本公司是国家高新技术企业，农业部兽医器械行业标准起草单位，全国畜牧行业标准化技术委员会专家成员单位。公司系浙江省“重合同、守信誉”企业、浙江省“农业科技企业”、浙江省“最具发展潜力100佳”企业。公司旗下品牌“报春鸟”荣获“浙江省著名商标”。

公司始终贯彻“诚信、高效、创新、发展”的经营理念，以质量和服务的双优承诺赢得国内外顾客的满意和信赖。

康瑞立足中国，面向世界，为全球畜牧业提供高品质的医疗器械，为世界畜牧行业发展做出更大的贡献。

ZHEJIANG KANGRUI APPARATUS TECHNOLOGY CO.,LTD ( former Shaoxing Kangerda Apparatus Co.,Ltd. ) is founded in 1996, integrating with research, produce and trade of animal veterinary apparatuses, animal husbandry apparatuses and agricultural machineries, and has independent import and export rights. Our company has two branches: Shaoxing Kangerda Import & Export Co.,Ltd. ; Zhejiang Kangrui animal veterinary and husbandry apparatuses research institute.

Kangrui is national High-tech Enterprise, the drafting unit of Industrial Standard for Animal Veterinary Apparatus of the Ministry of Agriculture and Industrial Standard for Veterinary Syringe, the first one passing the certifications of ISO9001 Quality Management System among counterparts, Zhejiang Contract-honoring & Promise-keeping Enterprise, Zhejiang Agricultural Technology Enterprise and Zhejiang Top 100 Most Potential Enterprises.

We are well trusted by global customers in the philosophy of “Credit, Efficiency, Innovation, Development” and the commitment of “Excellent Quality and Service” .

In the tenet of “Customer First, Credit Supreme” , we sincerely invite global customers to visit us.

## CONTENTS 目录



连续注射器系列 Continuous Syringes		水器系列 Drinkers & Feeders	
1	03   KED	6	26   KED
金属注射器系列 All Metal Syringes		养殖&输精系列 Feeding & AI Equipments	
2	12   KED	7	35   KED
塑钢注射器系列 Plastic Steel Syringe		喷雾器设备系列 Sprayers	
3	13   KED	8	42   KED
兽医注射针系列 Veterinary Needle		其他&驱赶器系列 Others & Prodder	
4	15   KED	9	44   KED
普通耳标系列 Ientifications		牧场&宠物用品系列 Farm & Pets' toys	
5	19   KED	9	49   KED

# 科研能力 Scientific Research

康瑞应对市场需求，积极拓展产业规模，产品涉及畜牧兽医器械，宠物用品及食品安全信息系统三大领域。公司秉承“务实创新，精益求精”的科研理念，拥有15项国家专利（6项发明专利）。旗下研究院与浙江大学等多所高校开展多项科研合作，引领传统畜牧兽医器械向产业化、电子化、信息化提升。

Adhering to the concept of “pragmatic, innovational and excelsior”, KANGRUI actively expands its industry scale, the products involve the animal husbandry and veterinary apparatus, pet supplies and food safety information system with plenty of national invention patents. Its R&D institute has a long-term cooperation with Zhejiang University and other colleges in new product development, aiming to lead the industrialization, electronization and informatization of animal husbandry and veterinary.

# Patent 专利证书

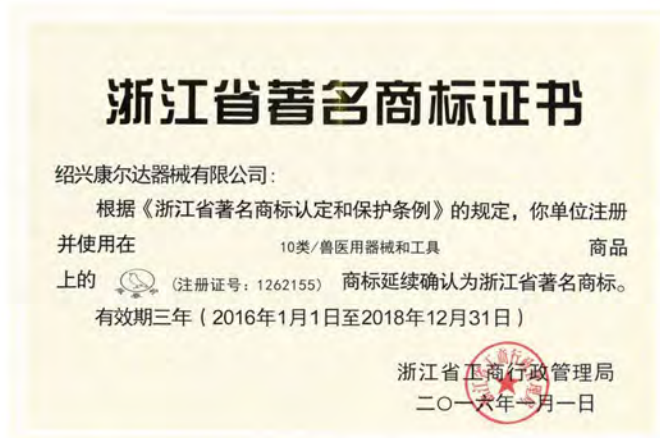
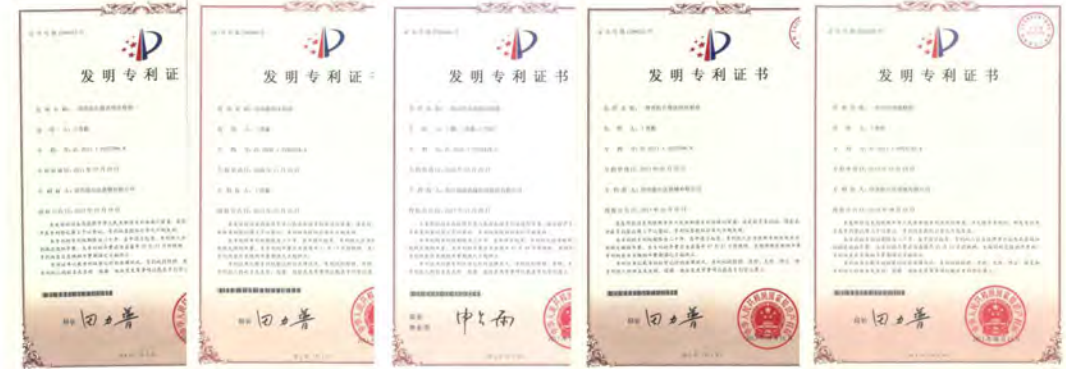

## 全自动注射器 KR1000 AUTOMATIC INJECTOR

### 1. 稳定性高 Remarkable stability

不同于普通的连续注射器，电动连续注射器的注射剂量和注射速度由电脑全自动控制，结合日本进口电机，可以做到稳定匀速的注射且剂量准确。整机保证20万次以上（易损件除外）的使用寿命，并提供2年质保  
The injection process is controlled by computer to ensure the stable injection speed and correct injection dose. With the precise design and strict quality control, KR1000 can be used over 200,000 times and has 2-year quality assurance.



### 2. 用途广泛 Multi usage

该产品的注射剂量可以轻易通过按钮调节，可以注射0.2ml-20ml的药液，以满足不同用户的需求。同时，本产品的针头兼容普通连续注射器的针头  
This versatile device can inject the vaccine from 0.2ml-20ml and supports different kinds of needles that make the device suitable for all situations

### 3. 适用不同进液方式 Covering all connection

该产品兼容导管式输液和瓶口式输液方式，结合我们提供的辅助装置，可以完美应对不同药剂需要。  
Whether you prefer using line feed connection or medication bottle connection, with KR1000 you can seamlessly transition between them. We've provide all accessory kits in our package to fit everything you need without other charges.

### 4. 数据记录 Efficient data storage and transferability

该产品会自己记录所有的注射数据，并通过usb传输到用户电脑，从而实现信息化管理  
Kr1000 automatically stored all operation data, which will be transferred to computers for further data management.

优势对比	电动注射器 Automatic Injector	手动注射器 Normal injector
精度 Precision	电脑控制，误差小于±1% Controlled by computer, less than ±1%	肉眼测量，误差大 Visual measurement, error can be large
人力 Power	电动注射 Electric	人力注射，长时间易疲劳 Easy to hand fatigue
注射数据 Data storage	自动储存，可直接传输到电脑 Auto saved and can transport to computer	手工记录 Hand-kept
注射效果 Injection effect	注射速度均匀，药液吸收效果好 The injection speed is even, and the medicine is well absorbed	注射速度难控制，药液容易溢出 The injection speed is hard to control, and the medicine is easy to overflow



**KD101 双管连续注射器**  
Double-barreled Continuous Syringe  
规格/Specs:1ml  
• Left is 1.0, right is 1ml  
• Double barrel  
• Luer-lock adaptor  
• brass raw material with chrome plated  
• High accurate valve system  
• Nylon handle  
• Light weight



**KD101-B 双管连续注射器**  
Double-barreled Continuous Syringe  
规格/Specs:2ml  
• Left is 2.0, right is 2ml  
• Double barrel  
• Luer-lock adaptor  
• brass raw material with chrome plated  
• High accurate valve system  
• Nylon handle  
• Light weight



**KD102 连续注射器B型**  
Continuous Syringe B-Type  
规格/Specs:1ml  
• Luer-lock adaptor  
• Brass raw material with chrome plated  
• High accurate valve systems  
• Light weight  
• 0.02-1.0ml continuous and adjustable  
• Precise dosage control  
• Easy to operation

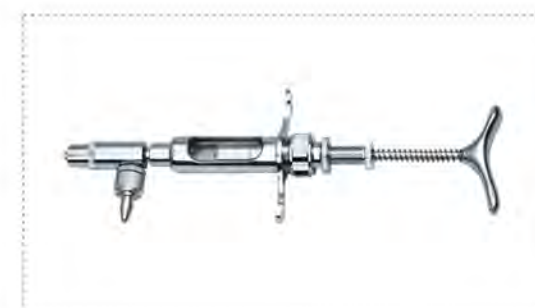

**KD103 连续注射器A型**  
Continuous Syringe A-Type  
规格/Specs: 2ml  
• Luer-lock adaptor  
• Brass raw material with chrome plated  
• High accurate valve systems  
• Light weight  
• 0.1-2ml continuous and adjustable  
• Precise dosage control



**KD104 连续注射器C型**  
Continuous Syringe C-Type  
规格/Specs: 0.5ml 1ml 2ml 5ml  
• Luer-lock adaptor  
• Brass raw material with chrome plated  
• High accurate valve systems  
• Light weight  
• 0.5ml: 0.01-0.5ml continuous and adjustable  
• 1ml: 0.02-1ml continuous and adjustable  
• 2ml: 0.1-2ml continuous and adjustable  
• 5ml: 0.2-5ml continuous and adjustable  
• Precise dosage control



**KD105 连续注射器D型**  
Continuous Syringe D-Type  
规格/Specs: 0.5ml 1ml 2ml 5ml

- Luer-lock adaptor
- Brass raw material with chrome plated
- High accurate valve systems
- Light weight
- 0.5ml: 0.01-0.5ml continuous and adjustable
- 1ml: 0.02-1ml continuous and adjustable
- 2ml: 0.1-2ml continuous and adjustable
- 5ml: 0.2-5ml continuous and adjustable
- Precise dosage control



**KD116 连续注射器H型(插瓶、吸液胶管两用)**  
Continuous Syringe H-Type  
(with bottle adapter and tube)  
规格/Specs: 0.5ml 1ml 2ml 5ml

- Luer-lock adaptor
- Brass raw material with chrome plated
- High accurate valve systems
- Light weight
- 0.5ml: 0.01-0.5ml continuous and adjustable
- 1ml: 0.02-1ml continuous and adjustable
- 2ml: 0.1-2ml continuous and adjustable
- 5ml: 0.2-5ml continuous and adjustable
- Precise dosage control



**KD106 连续注射器E型**  
Continuous Syringe E-Type  
规格/Specs: 2ml

- Luer-lock adaptor
- Brass raw material with chrome plated
- High accurate valve systems
- Light weight
- 0.1-2ml continuous and adjustable
- Precise dosage control



**KD107 连续注射器F型(塑钢)**  
Continuous Syringe F-Type  
规格/Specs: 1ml 2ml 3ml 5ml 6ml

- Luer-lock adaptor
- Material: Nylon
- 1ml: 0.02-1ml continuous and adjustable
- 2ml: 0.1-2ml continuous and adjustable
- 3ml: 0.2-3ml continuous and adjustable
- 5ml: 0.2-5ml continuous and adjustable
- 6ml: 0.2-6ml continuous and adjustable
- Sterilizable: -30°C-130°C



**KD108 连续注射器G型(塑钢)**  
Continuous Syringe G-Type  
规格/Specs: 1ml 2ml 3ml 5ml 6ml

- Luer-lock adaptor
- Material: Nylon
- 1ml: 0.02-1ml continuous and adjustable
- 2ml: 0.1-2ml continuous and adjustable
- 3ml: 0.2-3ml continuous and adjustable
- 5ml: 0.2-5ml continuous and adjustable
- 6ml: 0.2-6ml continuous and adjustable
- Sterilizable: -30°C-130°C



**KD130 连续注射器I型(塑钢)**  
Continuous syringe I-Type  
规格/Specs 1ml 2ml 5ml

- Luer-lock adaptor
- Material: Nylon
- 1ml: 0.02-1ml continuous and adjustable
- 2ml: 0.1-2ml continuous and adjustable
- 5ml: 0.2-5ml continuous and adjustable
- Sterilizable: -30°C-130°C



**KD109 连续注射器A型**  
Continuous Syringe A-Type  
规格/Specs: 5ml

- Luer-lock adaptor
- Material: Nylon
- 5ml: 0.2-5ml continuous and adjustable
- Sterilizable: -30°C-130°C
- Precise dosage control
- Easy to operation



**KD109B 连续注射器B型**  
Continuous Syringe B-Type  
规格/Specs: 5ml

- Luer-lock adaptor
- Material: Nylon
- 5ml: 0.2-5ml continuous and adjustable
- Sterilizable: -30°C-130°C
- Precise dosage control
- Easy to operation



**KD135 全铜连续注射器**  
Continuous Syringe(Brass)  
规格/Specs: 30ml 50ml

- Description
- All metal parts are made of brass material, nickel or chrome plated;
- with calibration
- Marks on glass barrel' perfect dose adjustment;
- suitable for the inoculation of livestock.
- clean well and oil with silicone oil, Regularly replace washers



**KD114 全金属连续注射器**  
Metal Continuous Syringe  
规格/Specs: 50ml

- Description
- Brass with chrome plated
- brass luer-lock with chrome plated
- With calibration
- Glass tube easy for cleaning
- suitable for the inoculation of livestock
- Clean well and oil with silicone oil, regularly replace washers



**KD115-A 手枪式连续注射器 (PC/TPX)**  
Pistol Continuous Syringe (PC/TPX)  
规格/Specs: 30ml 50ml

- Luer-lock adaptor
- Brass raw material with chrome plated
- Plastic barrel
- High accurate valve systems
- Light weight
- Precise dosage control



**KD115-B 手枪式连续注射器 (PP/TPX)**  
Pistol Continuous Syringe (PP/TPX)  
规格/Specs: 30ml 50ml

- Luer-lock adaptor
- Brass raw material with chrome plated
- Plastic barrel
- High accurate valve systems
- Light weight
- Precise dosage control



**KD117 连续注射器J型**  
Continuous Syringe J-Type  
规格/Specs: 5ml

- Luer-lock adaptor
- Brass raw material with chrome plated
- High accurate valve systems
- Light weight
- 5ml: 0.2-5ml continuous and adjustable
- Precise dosage control



**KD121**  
5ml长臂连续注射器 (A型)  
最大长度≥1.9米  
供药方式: 自动连续  
(直接插瓶, 吸液胶管两用)  
消毒方式: 自动连续  
剂量调节: 0.2ml-5ml

5ml Long handle Continuous Syringe(A-type)  
Size≥ 1.9 Meter  
Drug Supply Way:Automatic and Continuous  
(plastic bottle or Suction hose)  
Sterilize: Automatic and Continuous  
Dose adjustment: 0.2ml 5ml



**KD111 连续注射器A型、B型**  
Continuous syringe A-Type、B-Type  
规格/Specs 10ml

- Luer-lock adaptor
- Brass raw material with chrome plated & aluminium alloy
- High accurate valve systems
- Light weight
- 10ml: 1-10ml continuous and adjustable
- Precise dosage control



**KD110 连续灌药器 (注射器)**  
Continuous Drench (syringe)  
规格/Specs: 20ml

- Material: Nylon, super chrome plated brass drenching nozzle
- Unbreakable plastic barrel with spare pipe & needle
- Sterilizable : -30℃-130℃
- Easy of operation
- 20ml: 1-20ml continuous and adjustable



**KD118 连续灌药注射器Y型**  
Continuous Syringe (Drencher) Y-Type  
规格/Specs: 5ml 10ml 30ml

- Luer-lock adaptor & drench tube
- 5ml: 0.2-5ml continuous and adjustable
- 10ml: 1-10ml continuous and adjustable
- 30ml: 1-30ml continuous and adjustable
- All metal parts are made of brass material, nickel or chrome plated;
- with calibration
- Marks on glass barrel' perfect dose adjustment;
- suitable for the inoculation of livestock.
- clean well and oil with silicone oil, Regularly replace washers



**KD113 连续注射灌药器**  
Continuous Syringe (Continuous Drencher)  
规格/Specs: 10ml 20ml 50ml

- Material: Nylon, super chrome plated brass drenching nozzle
- Unbreakable plastic barrel with spare pipe & needle
- Sterilizable : -30℃-130℃
- Easy of operation
- 10ml: 1-10ml continuous and adjustable
- 20ml: 1-20ml continuous and adjustable
- 50ml: 5-50ml continuous and adjustable



**KD119**

(A) 储液箱

1. 灌注液储量: 1600ml
2. 消毒液储量: 500ml
3. 稀释液储量: 500ml

(B) 连续灌药枪

1. 规格: 5ml
2. 计量准确度: 全容量误差  $\leq \pm 3\%$
3. 剂量: 0.2~5ml 连续可调

(A) Liquid Tank

1. Perfusion Liquid Reserves: 1600ml
2. Disinfectant Reserves: 500ml
3. Dilutions Reserves: 500ml

(B) Continuous Drencher

1. Specifications: 5ml
2. Dose Accuracy: Full Capacity error  $\leq \pm 3\%$
3. Dose: 0.2~5ml continuously adjustable



**KD119 (B)**

多功能连续注射(灌)药器

- 1、灌注液储量: 200ml
- 2、被稀释药瓶残留  $\leq 0.3\text{ml}$
- 3、剂量: 0.2~0.5ml 连续可调
- 4、剂量准确度: 全容量误差  $\leq \pm 3\%$

Multi function continuous injection (irrigation) medicine device

- 1 filling liquid reserves: 200ml
- 2 diluted bottle residue is less than or equal to 0.3ml
- 3 dose: 0.2~5ml continuous adjustable
- 4 measurement accuracy: full capacity error less than 3%



**KD145 药壶**

Medicine Bottle

规格/Specs: 500ml, 2.5L

Material: PP

With Straps, Easy to Carry

Automatic Air Return System

Sterilizable:  $-30^{\circ}\text{C}$ — $120^{\circ}\text{C}$



**KD140 连续灌药器**

Continuous Drench

规格/Specs: 20ml

- Material: Super chrome plated brass drenching nozzle
- Unbreakable plastic barrel
- Sterilizable:  $-30^{\circ}\text{C}$ — $130^{\circ}\text{C}$
- Easy of operation
- 20ml: 1-20ml continuous and adjustable



**KD141 连续灌药器**

Continuous Drench

规格/Specs: 20ml, 50ml

- Material: Super chrome plated brass drenching nozzle
- Unbreakable plastic barrel
- Sterilizable:  $-30^{\circ}\text{C}$ — $130^{\circ}\text{C}$
- Easy of operation
- 20ml: 1-20ml continuous and adjustable
- 50ml: 1-50ml continuous and adjustable



**KD142 连续灌药器**

Continuous Drench

规格/Specs: 50ml

- Material: Super chrome plated brass drenching nozzle
- Unbreakable plastic barrel with metal cover
- Sterilizable:  $-30^{\circ}\text{C}$ — $130^{\circ}\text{C}$
- Easy of operation
- 50ml: 1-50ml continuous and adjustable



**KD141 连续灌药器(弯管)-A型**

Drench Nozzle A Type

- Material: Super chrome plated brass drenching nozzle
- Unbreakable plastic barrel with metal cover
- Sterilizable:  $-30^{\circ}\text{C}$ — $130^{\circ}\text{C}$
- Easy of operation
- 50ml: 1-50ml continuous and adjustable



**KD141 连续灌药器(弯管)-B型**

Drench Nozzle B Type

- Material: Super chrome plated brass drenching nozzle
- Unbreakable plastic barrel with metal cover
- Sterilizable:  $-30^{\circ}\text{C}$ — $130^{\circ}\text{C}$
- Easy of operation
- 50ml: 1-50ml continuous and adjustable



KD314 滴液器  
A drop head  
B spray head  
Luer-lock  
Fitting with All of Syringes

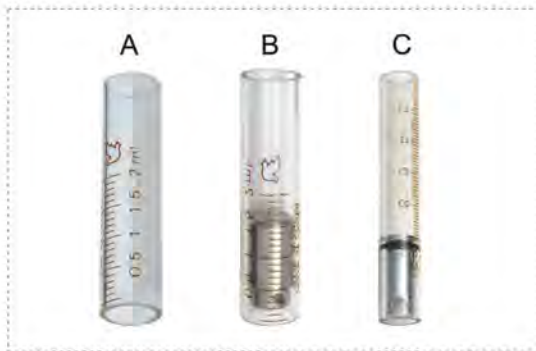

KD124 玻璃管配件  
Glass Tube For Continuous Syringe  
Specs: 1ml 2ml 5ml  
A: Glass tube  
B: Glass tube with stainless steel piston  
C: Glass tube with copper piston

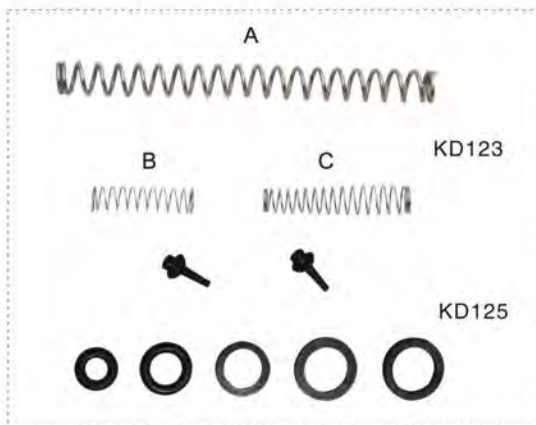

KD123 连续注射器弹簧  
Spring For Continuius Syringe

KD125 连续注射器橡胶件  
Rubber Parts For Continuous Syringe



KD150 连续注射器配件 (适用于KD107、KD108)  
Adaptor and connrctor For Syringe  
KD107、KD108、KD130



KD201 奶牛结核疫苗注射器  
Syringe for Bovine Tuberculosis  
规格/Specs: 2.5ml

- Brass raw material with chrome plated
- Glass tube easy for cleaning
- Adjustable rubber piston rod



KD202 金属射器C型  
High-Accuracy Metal Syringe C-Tye  
规格/Specs: 20ml

- Luer-lock adaptor
- Brass raw material with chrome plated
- Glass tube easy for cleaning
- Adjustable rubber piston rod



KD203 金属注射器  
Metal Syringe  
规格/Specs: 20ml

- Luer-lock adaptor
- Brass raw material with chrome plated
- Glass tube easy for cleaning
- Adjustable rubber piston rod



KD204 金属注射器 (带固针套)  
Metal Syringe (With Luer-lock)  
规格/Specs: 10ml 20ml 20mlB 30ml  
40ml 50ml 50mlB 100ml

- Luer-lock adaptor
- Brass raw material with chrome plated
- Glass tube easy for cleaning
- Adjustable rubber piston rod



KD206 橡胶件  
Rubber Piece  
规格/Specs: 10ml 20ml 50ml 100ml

KD205 玻璃管  
Glass Tube  
规格/Specs: 10ml 20ml  
20mlB 30ml 40m  
50ml 50mlB 100ml





KD301 塑钢注射器B型 (TPX)  
Plastic Steel Syringe B-Type(TPX)  
规格/Specs: 20ml

- Durable syringe with luer lock adaptor
- Reusable
- Nylon rod with engraved scale
- High quality Plastic (PC or TPX) with UV additive
- Color of plastic piston, cover and handle are favorable
- Transparent barrel with engraved scale or transparent scale are favorable
- Sterilizable : -30℃-130℃



KD302 塑钢注射器 (TPX)  
Plastic Steel Syringe (TPX)  
规格/Specs: 10ml 20ml 30ml 50ml

- Durable syringe with luer lock adaptor
- Reusable
- Brass rod with engraved scale
- High quality Plastic (PC or TPX) with UV additive
- Color of plastic piston, cover and handle are favorable
- Transparent barrel with engraved scale or transparent scale are favorable
- Sterilizable : -30℃-130℃



KD303 塑钢注射器C型 (TPX/PC不可调)  
Plastic Steel Syringe Without Graduation  
C-Type(TPX/PC)  
规格/Specs: 10ml 20ml 30ml 50ml

- Durable syringe with luer lock adaptor
- Reusable
- SUS304 stainless steel rod
- High quality Plastic (PC or TPX) with UV additive
- Color of plastic piston, cover and handle are favorable
- Transparent barrel with engraved scale or transparent scale are favorable
- Sterilizable : -30℃-130℃

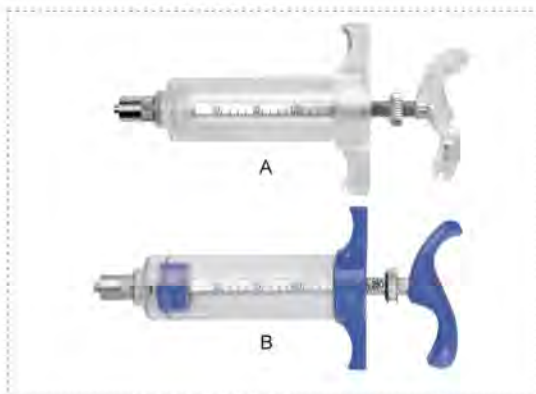

KD304 塑钢注射器D型 (TPX/PC电印可调)  
Plastic Steel Syringe With Graduation  
D-Type (TPX/PC)  
规格/Specs: 10ml 20ml 30ml 50ml

- Durable syringe with luer lock adaptor
- Reusable
- SUS304 stainless steel rod
- High quality Plastic (PC or TPX) with UV additive
- Color of plastic piston, cover and handle are favorable
- Transparent barrel with engraved scale or transparent scale are favorable
- Sterilizable : -30℃-130℃



KD307 塑钢注射器G型 (TPX)  
Plastic Steel Syringe G-Type(TPX)  
规格/Specs: 5ml 10ml 20ml 30ml

- Durable syringe with luer lock adaptor
- Reusable
- SUS304 stainless steel rod
- High quality Plastic (PC or TPX) with UV additive
- Color of plastic piston, cover and handle are favorable
- Sterilizable : -30℃-130℃



KD308 塑钢注射器H型 (TPX)  
Plastic Steel Syringe H-Type  
(Offset-style TPX)  
规格/Specs: 100ml

- Durable syringe with luer lock adaptor
- Reusable
- SUS304 stainless steel rod
- High quality Plastic (PC or TPX) with UV additive
- Color of plastic piston, cover and handle are favorable
- Sterilizable : -30℃-130℃



KD309 塑钢注射器I型 (TPX)  
Plastic Steel Syringe I-Type (TPX)  
规格/Specs: 5ml 10ml 20ml 30ml 50ml

- Durable syringe with luer lock adaptor
- Reusable
- SUS304 stainless steel rod
- High quality Plastic (PC or TPX) with UV additive
- Color of plastic piston, cover and handle are favorable
- Sterilizable : -30℃-130℃

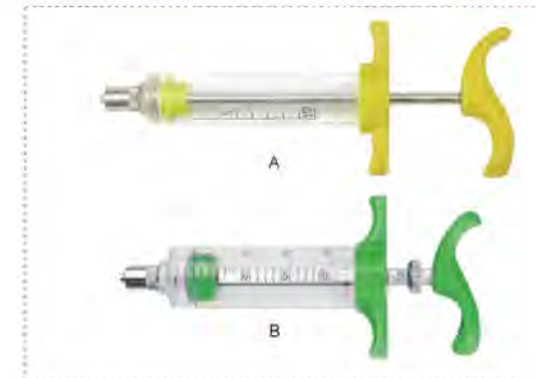

KD310 塑钢注射器J型 (TPX)  
Plastic Steel Syringe J-Type (TPX)  
规格/Specs: 10ml 20ml 30ml 50ml

- Durable syringe with luer lock adaptor
- Reusable
- SUS304 stainless steel rod
- High quality Plastic (PC or TPX) with UV additive
- Color of plastic piston, cover and handle are favorable
- Sterilizable : -30℃-130℃

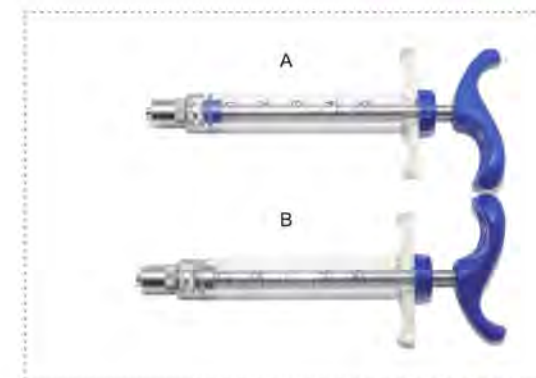

KD313 塑钢注射器K型 (TPX)  
Plastic Steel Syringe K-Type (TPX)  
规格/Specs: 5ml

- Durable syringe with luer lock adaptor
- Reusable
- SUS304 stainless steel rod
- High quality Plastic (PC or TPX) with UV additive
- Color of plastic piston, cover and handle are favorable
- Sterilizable : -30℃-130℃



KD401 兽医注射针 (10支装)  
Veterinary needle (10pcs per box)



KD402 兽医注射针 (12支装)  
Veterinary Needle (12 pcs per box)



KD403 兽用注射针B型 (12支装)  
Veterinary needle B-type (12pcs per box)



KD404 兽用注射针D型 (12支装)  
Veterinary needle D-type (12pcs per box)



KD405 兽用注射针C型 (12支装)  
Veterinary needle C-type (12pcs per box)

**Description**

SUS304 stainless steel pipe  
Luer lock brass rectangle hub  
Pipe & hub rivet connection in five direction  
Very sharp needle with tri-beveled  
1 dozen per plastic box, 1 gross per whit box.

Needles Gauge and Length		BOX/CASE/Carton
D×L(G×incl)	D×L(mm×mm)	
14G×2"	2.0×50	12/144/7200
14G×1 1/2"	2.0×40	12/144/7200
14G×1"	2.0×25	12/144/7200
14G×3/4"	2.0×20	12/144/7200
14G×5/8"	2.0×15	12/144/7200
15G×2"	1.8×50	12/144/7200
15G×1 1/2"	1.8×40	12/144/7200
15G×1"	1.8×25	12/144/7200
15G×3/4"	1.8×20	12/144/7200
15G×5/8"	1.8×15	12/144/7200
16G×2"	1.6×50	12/144/7200
16G×1 1/2"	1.6×40	12/144/7200
16G×1"	1.6×25	12/144/7200
16G×3/4"	1.6×20	12/144/7200
16G×5/8"	1.6×15	12/144/7200
16G×1/2"	1.6×13	12/144/7200
18G×1 1/2"	1.2×40	12/144/7200
18G×1"	1.2×25	12/144/7200
18G×3/4"	1.2×20	12/144/7200
18G×5/8"	1.2×15	12/144/7200
18G×1/2"	1.2×13	12/144/7200
20G×1 1/2"	0.9×40	12/144/7200
20G×1"	0.9×25	12/144/7200
20G×3/8"	0.9×10	12/144/7200

\*Regular size only, please contact with sales for more size



KD406 通奶针  
Teat Cannula  
规格/Specs: 20×80 25X100

Brass bottom and stainless steel pipe with chrome plated



KD407 结核疫苗注射针  
Needle for Bovine Tuberculosis syringe

SUS304 stainless steel pipe  
Very sharp needle with tri-beveled  
10pcs per plastic box



KD408 一次性注射针  
Disposable Needle With Sheath

Stainless steel cannula;  
Translucent, colour-coded luer lock hub;  
Ultra-sharp, tri-bevelled, anti-coring;  
Blister packaging;  
Sterile, non-pyrogenic;  
Silicone coating assures ease of penetration;  
Minimizing animal discomfort



KD409 铝座针  
Aluminum Needle

SUS304 stainless steel pipe  
High-accuracy luer lock aluminum hub  
Ultra-sharp, tri-bevelled, anti-coring needle  
Each piece with color-coded cartridges  
100pcs with one neutral box(OEM packaging is favorable)



KD410 采血针 Blood Collection Needle  
Stainless steel cannula;  
100pcs per box, 1 box within a needle holder  
OEM packaging is favorable

KD411 采血管 Vacuum Collective Tube  
3ml-10ml  
Material: Glass or Plastic  
OEM packaging is favorable

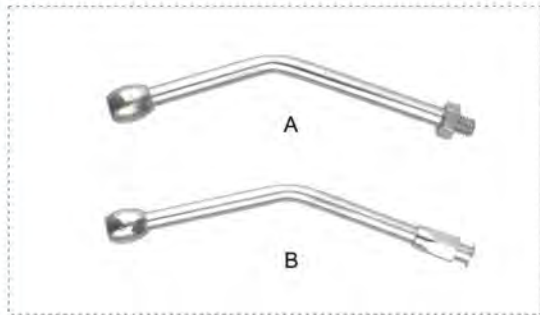

KD126 Φ6mm喂药管 Drench cannula  
规格/Specs: A:Φ6x110mm B:Φ6x120mm  
Brass drench cannula with chrome plated  
A type thread mold match with plastic steel syringe directly  
B type Match with all syringe adaptor

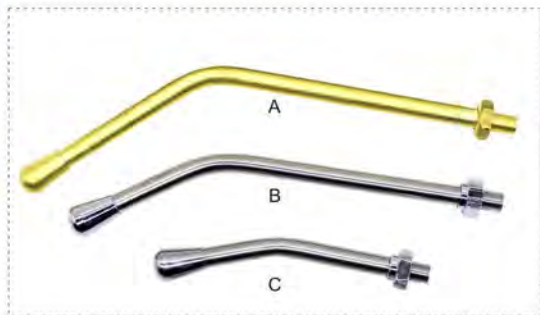

KD127 喂药管Drench cannula  
Φ10mm  
Brass drench cannula is made of brass raw material  
Each piece with one brass with chrome plated nut  
Strong silicon O-ring protect leaking  
A type with chrome plated 24.5cm  
B type with chrome plated 21.5cm  
C type without any plating 13.5cm



KD128 喂药管Drench cannula  
Φ16mm×24.5cm  
Brass drench cannula is made of brass raw material  
Each piece with one brass with chrome plated nut  
Strong silicon O-ring protect leaking  
With chrome plated

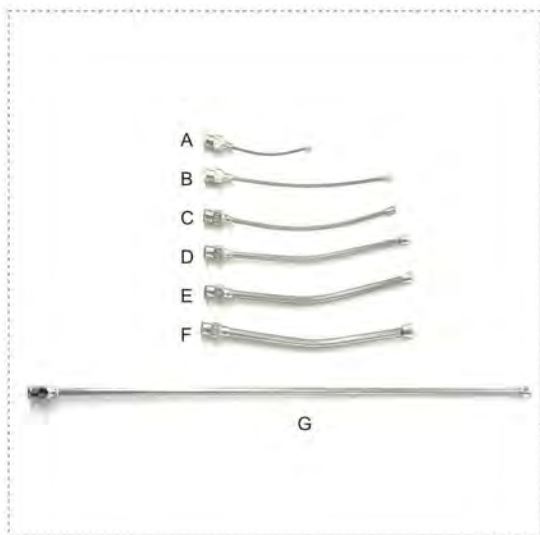

KD129 Bird drench nozzle  
Hub material: Brass  
Drenching needle material: SUS304 stainless steel  
A: 1.2x52mm  
B: 1.5x93mm  
C: 1.9x94mm  
D: 2.6x101mm  
E: 3.4x103mm  
F: 4.2x104mm  
G: 3x244mm



KD312: 一次性注射器  
Disposable Syringe With Needle  
规格/Specs: 1ml~100ml  
Plastic sterile syringe  
Latex free, luer lock or luer slip, with or without needle  
We could supply 1ml,2ml,3ml,5ml,10ml,20ml,30ml,50ml  
PE or blister packing

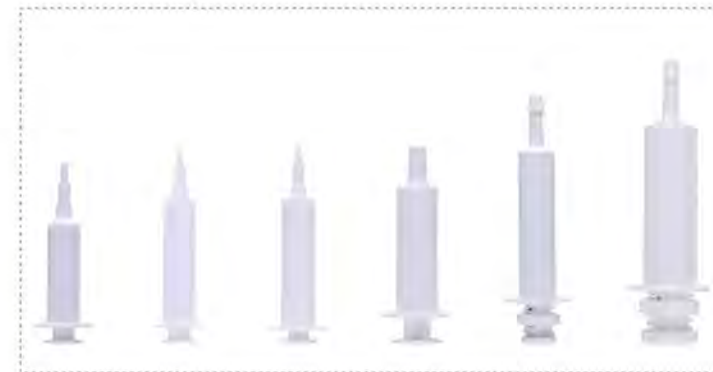

KD315 塑料注射针  
Plastic Veterinary Syringe  
Specs: 8ml 10ml 13ml 20ml 30ml 60ml



KD320 输液器 Infusion  
Material: PVC  
With SUS304 stainless steel needle  
With Adjuster

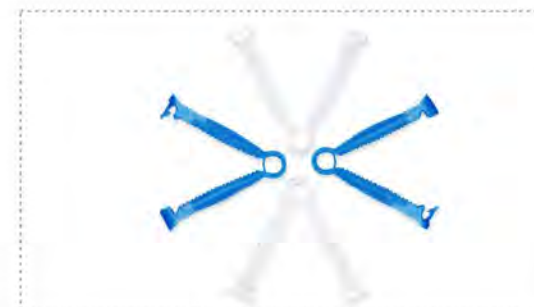

KD320 猪用脐带夹 Umbilical cord clamps  
High polymer plastics  
Safe and hygienic, avoid infection  
Sleek sawtooth  
Stable clamping, easy to retract and release

Colors:

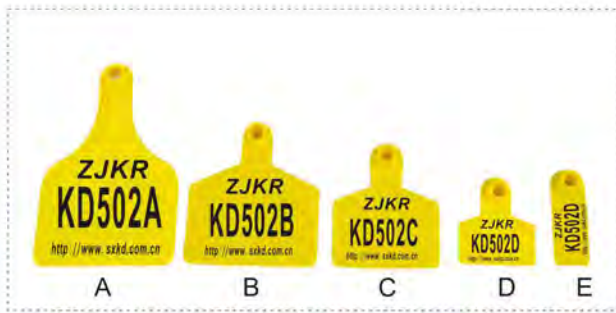

普通耳标 Plastic ear tag  
Material: Polyurethane with UV additive  
A: 115×75mm B: 81×72mm  
C: 70×58mm D: 48×41mm  
E: 53×18mm  
KD501 Ear tag without laser printing  
KD502 Ear tag with laser printing

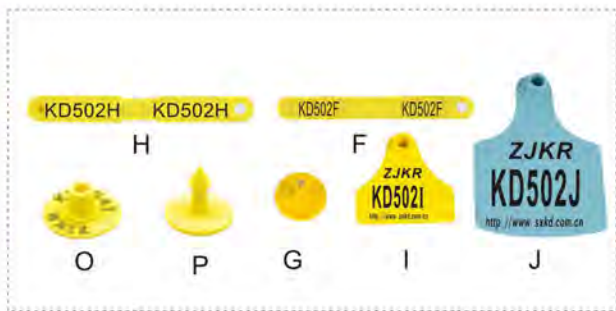

普通耳标 Plastic ear tag  
Material: Polyurethane with UV additive  
F: 75×9mm J: 102×72mm  
G: (Φ27-Φ30)×23mm/25mm  
H: 88×10mm I: 55×55mm  
O: Φ27 P: Φ27/Φ28  
KD501 Ear tag without laser printing  
KD502 Ear tag with laser printing

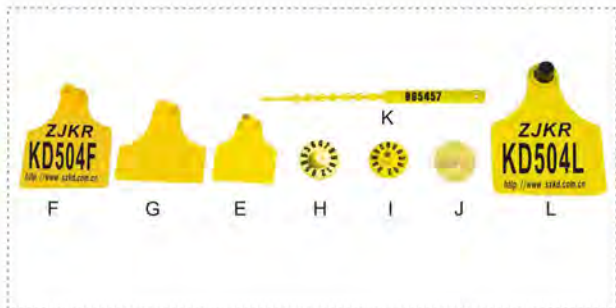

普通耳标 Plastic ear tag  
Material: Polyurethane with UV additive  
F: 78×61mm G: 61×61mm H: Φ29mm  
I: Φ32mm J: Φ27(锥头无金属件 / without metal tip)  
K: 100×6mm L: 100×75mm  
KD503 Ear tag without laser printing  
KD504 Ear tag with laser printing



普通耳标 Plastic ear tag  
Material: Polyurethane with UV additive  
A: 75×65mm B1: 78×58mm B2: 75×58mm  
C: 76×60mm D: 51×42mm  
M: 80×58mm N: 60×57mm  
KD503 Ear tag without laser printing  
KD504 Ear tag with laser printing



普通耳标 Plastic ear tag  
Material: Polyurethane with UV additive  
A: 94×73mm B: 80×61mm C: 77×60mm  
D: 49×42mm E: 67×54mm, 75×54mm  
KD505 Ear tag without laser printing  
KD506 Ear tag with laser printing



普通耳标 Plastic ear tag  
Material: Polyurethane with UV additive  
F: Φ28mm G: 63×60mm  
H: 60×58mm I: 60×55mm, 77×55mm  
J: 60×55mm, 77×55mm  
KD505 Ear tag without laser printing  
KD506 Ear tag with laser printing



KD550 一体式耳标  
Z Tag  
规格/Size: 112×76mm 80×60mm 58×46mm  
Size: 112\*76mm  
Material: TPU, can use at least 10 years  
UV resistant  
For cattle, horse, pig, goat use  
Easy to write, hard to fade and break



KD551 挂脖式标牌 Neck Tag  
Material: plastic TPU with SGS certificate  
Size: high 80\*width 65mm, hole 16mm diameter  
weight: 8 gram per pc  
Color: yellow, blue, orange, and so on.  
Package: 100pcs per poly bag



KD552 禽用塑料脚环  
Platic Poultry Ring  
Material: PP  
100PCS with a plastic box  
weight: 0.25g size: height: 8mm, ID: 8mm, OD: 11.5mm  
weight: 0.32g size: height: 9mm, ID: 12mm, OD: 15mm  
weight: 0.67g size: height: 10mm, ID: 16mm, OD: 20mm



KD745 颈圈标记 Cow neck strap marker  
Neck Strap Marker  
With belt and number 0-9

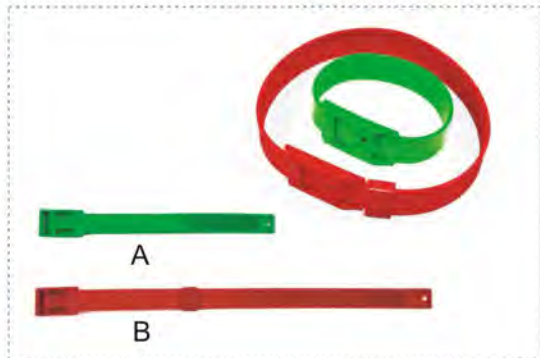

KD740 标记圈 leg band and neck band  
A: Legbands 36cm long  
B: Neckbands 59cm long  
bule,pink,orange,red,yellow,green



KD917 A: 进口耳标笔 B: 国产耳标笔  
C: 耳标笔C型  
A: Ear- mark pen from USA  
B: Ear- mark pen made in China  
C: Ear- mark pen C-Type  
marking ear tag for cattle,sheep, pigs!  
100% infiltration and persistent don't rub off.



KD712 刺号钳  
Tattooing Forceps Ink 墨水  
Tattoo plier is precision made of SS 304  
Two sizes available: big size can put 8 numbers or words,  
small size can put 4  
The tattoo digits can be loaded from the front, and as each  
is individually located,  
no blanks are required. Digits cannot be inverted accidentally.  
The positive ear release prevents points of the digits from  
scratching or blurring the tattoo mark.



KD915 蜡笔  
Crayon  
Material: 50% soft wax, 20% white oil, and filling material  
Capacity: 65-70g  
Melting point: 48°C  
Full colors available



KD507-B(LF) 低频电子耳标  
Low frequency electronic ear tag  
频率/ Frequency: 134.2 Khz  
规格/size: φ 30mm\*13mm  
读写标准/ Reading standard: ISO11784/5 FDX /HDX  
读写距离/ Reading distance: 5-25cm



KD507-C(LF) 带标识牌低频电子耳标  
Low frequency electronic ear tag with visual tag  
频率/ Frequency: 134.2 Khz  
规格/Size (L\*W\*H): 84mm\*57mm\*1.5mm  
读写标准/ Reading standard: ISO11784/5 FDX /HDX  
读写距离/ Reading distance: 5-25cm



KD507-D(LF) 低频电子耳标  
Low frequency electronic ear tag  
频率/ Frequency: 134.2 Khz  
规格/size: φ 30mm\*13mm  
读写标准/ Reading standard: ISO11784/5 FDX /HDX  
读写距离/ Reading distance: 5-25cm



KD530-LF低频公标电子耳标  
Low frequency electronic ear tag (male tag)  
频率/ Frequency: 134.2 Khz  
规格/Size: φ 30mm\*23mm  
读写标准/ Reading standard: ISO11784/5 FDX /HDX  
读写距离/ Reading distance: 5-25cm



KD531-LF带标识牌低频电子耳标 (反光)  
Low frequency electronic ear tag ( Reflective )  
频率/ Frequency: 134.2 Khz  
规格/Size (L\*W\*H): 83mm\*55mm\*1.5mm  
读写标准/ Reading standard: ISO11784/5 FDX /HDX  
读写距离/ Reading distance: 5-25cm



KD532-UHF超高频电子耳标  
Ultra high frequency electronic ear tag  
频率/Frequency: 860Mhz-960Mhz  
规格/Size (L\*W\*H): 78mm\*57mm\*1.8mm  
读写距离/ Reading distance: 0-4m



KD533-UHF超高频电子耳标  
Ultra high frequency electronic ear tag  
频率/Frequency: 860Mhz-960Mhz  
规格/Size: 52mm\*17mm\*1.9mm  
读写距离/ Reading distance: 0-1m



KD534-UHF超高频电子耳标  
Ultra high frequency electronic ear tag  
频率/Frequency: 860Mhz-960Mhz  
规格/Size: φ 30mm\*23mm  
读写距离/ Reading distance: 0-1m



KD535-UHF 超高频电子耳标  
Ultra high frequency electronic ear tag  
频率/Frequency: 860Mhz-960Mhz  
规格/Size: 100mm\*17mm\*1.9mm  
读写距离/ Reading distance: 0-1m



KD536-UHF 超高频电子耳标  
Ultra high frequency electronic ear tag  
频率/Frequency: 860Mhz-960Mhz  
规格/Size: 32mm\*33mm\*1.9mm  
读写距离/ Reading distance: 0-1m



KD540 低频小型手持式识读器  
Portable mini RFID reader ( LF )  
工作频率/ working frequency: 134.2 Khz  
处理器/ CPU: ARM(STM32)  
协议标准/ REFERENCE STANDARD: ISO 11784/5, FDX-B, HDX  
读取距离/ READING DISTANCE: FDX 17CM, HDX 20CM



KD541低频长杆识读器  
RFID STICK READER (LF)  
工作频率/ working frequency: 134.2 Khz  
处理器/ CPU: ARM(STM32)  
协议标准/ REFERENCE STANDARD: ISO 11784/5, FDX-B, HDX  
读取距离/ READING DISTANCE: FDX 15CM, HDX 20CM  
延长杆长度/ stick length : 80 cm



KD542手持式高级识读器(低频/超高频)  
PORTABLE ADVANCED READ-WRITE DEVICE (LF/UHF)  
工作频率/ working frequency: 134.2 Khz/ 860-960Mhz  
操作系统/ OPERATING SYSTEM: ANDROID 4.4  
协议标准/ REFERENCE STANDARD: ISO 11784/5, FDX-B, HDX/ ISO18000-6C  
读取距离/ READING DISTANCE: FDX 15CM, HDX 20CM (LF)  
0.5M-4M(UHF)  
通讯模块/ COMMUNICATION MODULE: GPRS/ WIFI/ BLUETOOTH



KD544低频桌面识读器  
Low frequency read-write device  
工作频率/ working frequency: 134.2 Khz  
协议标准/ REFERENCE STANDARD: ISO 11784/5, FDX-B, HDX  
读取距离/ READING DISTANCE: FDX 5CM, HDX 5CM



KD543 固定式大功率识读器(低频/超高频)  
FIXED PANEL RFID READER(LF/UHF)  
工作频率/ working frequency: 134.2 Khz/ 860-960Mhz  
协议标准/ REFERENCE STANDARD: ISO 11784/5, FDX-B, HDX/ ISO18000-6C  
读取距离/ READING DISTANCE: FDX 0.5-1M M, HDX 0.5-1M (LF)  
0.5-8M(UHF)



**KD509多用途耳标钳(适用于电子耳标及普通常规耳标)**  
Multi-use Ear Tag Applicator  
(For Electrical Ear Tag And Common ear tag)  
Applying all universal plastic ear tags and RFID tags  
Removable black plastic clip for applying electronic ear tags and visual ear tags  
Deep jaw makes proper placement easier.  
Grip is designed to ease hand fatigue from repeated use.  
each ear tag applicator with two super quality pin  
( the pin no deformation under the force of 1400N )  
sandy surface for protecting slipping.  
packaging: each piece with one blister packaging  
OEM packaging is available

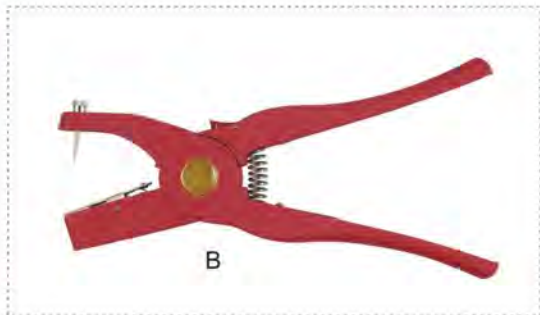

**KD510 耳标钳 B型**  
Ear Tag Applicator B-Type  
A must for applying ear tags  
Removable black plastic clip for applying visual ear tags  
each ear tag applicator with two super quality pin  
( the pin no deformation under the force of 1400N )  
sandy surface for protecting slipping.  
packaging: each piece with one blister packaging.  
OEM packaging is available



**KD514半自动耳标钳**  
Semi-Automatic Ear Tag Applicator  
A must for applying ear tags  
Removable black plastic clip for applying visual ear tags  
each ear tag applicator with two super quality pin  
packaging: each piece with one plastic bag packaging.  
OEM packaging is available



**KD517 耳标钳**  
Ear Tag Applicator  
Specially for z tag application  
Length: 26cm  
Material: nylon  
Easy to take



**KD513耳标针**  
Needle For Ear Tag Applicator  
规格 / Specs:A-Type  
Material: Hard stainless steel



**KD601**  
1/2" Hexagonal Stainless Steel Nipple  
Drinkers For Piglet  
1/2" 猪用饮水器(不锈钢)

**KD603**  
1/2" Flat-round Stainless Steel Nipple  
Drinkers For Piglet  
1/2" 猪用饮水器(不锈钢)



**KD602**  
1/2" Hexagonal Copper Nipple Drinkers  
For Piglet  
1/2" 猪用饮水器(铜)

**KD611** 1/2" Nipple Feed Drinkers  
Copper For Piglet  
1/2" 猪用饮水器(铜)



**KD604** 1/2" Nipple Drinkers  
Hexagonal Stainless Steel  
1/2" 猪用饮水器(不锈钢)

**KD606** 1/2" Nipple Drinkers  
Flat-round Stainless Steel  
1/2" 猪用饮水器(不锈钢)



**KD608** 1/2" Nipple Drinkers  
Hexagonal Stainless Steel  
1/2" 猪用饮水器(不锈钢)

**KD609** Nipple Drinkers  
1/2" Flat-round Stainless Steel  
1/2" 猪用饮水器(不锈钢)



KD607 1/2" Nipple Drinkers  
Flat-round Copper  
1/2" 猪用饮水器 (铜)

KD605 1/2" Nipple Drinkers  
Hexagonal Copper  
1/2" 猪用饮水器 (铜)



KD610 1/2" Nipple Feed Drinkers  
Stainless Steel  
1/2" 猪用饮水器 (不锈钢)

KD612 1/2" Nipple Feed Drinkers  
Stainless Steel  
1/2" 猪用饮水器 (不锈钢)



KD670 1/2" ball type nipple drinker  
1/2" 弹珠饮水器

KD671 1/2" ball type nipple drinker  
1/2" 弹珠饮水器



KD672 1/2" Nipple Feed Drinkers  
Stainless Steel  
1/2" 猪用饮水器 (不锈钢)

KD673 1/2" Nipple Feed Drinkers  
Stainless Steel  
1/2" 猪用饮水器 (不锈钢)



KD674 1/2" Nipple Feed Drinkers  
Stainless Steel  
1/2" 猪用饮水器 (不锈钢)

KD675 1/2" Nipple Feed Drinkers  
Stainless Steel  
1/2" 猪用饮水器 (不锈钢)



KD613 猪用饮水碗  
Drinker Bowl For Pig  
规格/Specs: 0.5L  
Plastic drinking bowl with UV additive  
With stainless steel nipple drinker  
Professional hook easy for assembling  
Stainless steel netting filter



KD614 饮水碗A型  
Drinking Bowl A-Type  
规格/Specs: 1.2L  
Plastic drinking bowl with UV additive;  
with brass valve systems;  
Stainless steel hook easy for assembling;  
Kinds of color is available(normal color green or black)  
Package: 2pcs per neutral box  
OEM Packaging is available



KD615 饮水碗B型 (喷粉)  
Drinking Bowl B-Type (Powder Coating)  
规格/Specs: 1.8L 1.2L  
Cast iron drinking bowl with strong brass valve systems  
Production finishing: powder coating  
Smooth finishing, round edge  
Flip paddle safety and suitable for animals  
Professional design easy for cleaning  
Capacity: 2L  
Packaging: each piece with one neutral box,



KD616 饮水碗C型  
Drinking Bowl C-Type  
规格/Specs: 1.8L 1.2L  
Cast iron drinking bowl with black powder coating  
Smooth surface and edge protect animal cutting  
With professional brass valve systems  
Stainless steel hook easy for assembling  
Two pieces with one neutral box.





**KD617 牛用饮水碗D型**  
Drinking Bowl D-type  
Plastic drinking bowl with UV additive



**KD680 牛用饮水碗E型**  
Stainless steel cattle drinking bowl  
It's made of 1.0mm thickness Stainless steel sheet;  
With hinged lid easy for maintenance ;  
A feature of this bow is the sloping to the front bottom ,which brings ;  
Any debris forward for easy cleaning ;  
Nylon float systems assembly . No drain incorporated ;  
Dimensions : 26cmLx26mWx11cmD Capacity 2.5. litres ;  
Packaging : OEM packaging is available ;



**KD681 不锈钢饮水碗**  
Stainless steel cattle drinking bowl  
规格/Size: 150x210x90mm(Small)  
190x270x110mm(Medium)  
210x290x160mm(Big)  
Material: 1.0mm thickness SUS304 Stainless steel  
Stainless steel pipe with 1/2" connection  
Professional design save water, no water waste  
G-1/2" thread (European pipe thread) or NPT-1/2" (American pipe thread)  
is favorable.



**KD682 不锈钢饮水碗**  
Stainless steel cattle drinking bowl  
规格/Size: 130x80mm(Small)  
150x105mm(Medium)  
170x140mm(Big)  
210x190mm(Big pig)  
Material: 1.0mm thickness SUS304 Stainless steel  
Stainless steel pipe with 1/2" connection  
Professional design save water, no water waste  
G-1/2" thread (European pipe thread) or NPT-1/2" (American pipe thread)  
is favorable.



**KD683 不锈钢水位器接水盆**  
Stainless steel water cup  
规格/Size: 325x220x70mm(Small)  
380x250x90mm(Medium)  
340x200x90mm(Big)  
Material: 1.0mm thickness SUS304 Stainless steel  
Professional design save water, no water waste



**KD684 不锈钢水位器接水盆**  
Stainless steel water cup  
规格/Size: 195x170x78mm  
Material: 1.0mm thickness SUS304 Stainless steel  
Professional design save water, no water waste



**KD685 不锈钢饮水碗**  
Stainless steel cattle drinking bowl  
规格/Size: 420x350x230mm (Small)  
480x400x250mm(Big)  
Material: 1.0mm thickness SUS304 Stainless steel



**KD618 不锈钢补料槽**  
Stainless steel piglet feeder  
规格/Size: A:280x65mm  
B:250x65mm  
C:250x65mm  
Material: 1.0mm thickness SUS304 Stainless steel  
Stainless steel pipe with 1/2" connection  
Professional design save water, no water waste



**KD625 鸡用饮水器**  
Nipple drinker for chicken  
304 stainless steel ball,nipple  
360°C water Outflow  
High standard rubber O-ring, no leakage



**KD628 禽用喂食器**  
Chicken Feeder  
Size: 1KG, 3KGS, 6KGS, 10KGS  
Gear box feeder is made of super quality plastic  
with UV additive  
kinds of color is available  
screen printing is available



**KD 628T 禽用喂食器**  
Thicker Model  
Size: 1KGS, 3KGS, 6KGS, 10KGS  
Gear box feeder is made of super quality plastic with UV additive  
kinds of color is available  
screen printing is available



**KD 629 禽用喂食器**  
Chicken feeder  
Size: 1KG, 2KGS, 3KGS, 6KGS, 8KGS  
Gear box feeder is made of super quality plastic with UV additive  
kinds of color is available  
screen printing is available



**KD 631 禽用喂食器**  
Poultry Feeder  
Size: 1KG, 2KGS, 3KGS, 6KGS, 8KGS  
Gear box feeder is made of super quality plastic with UV additive  
kinds of color is available  
screen printing is available



**KD 630 禽用饮水器**  
Poultry Drinker  
Size: 1L, 2L, 4L, 5.5L, 7.5L  
Straight type poultry drinker is made of super quality plastic With UV additive  
Professional design with galvanized hanging  
Transferable design easy for wash



**KD 632 禽用饮水器**  
Poultry Drinker  
Size: 1L 2L 4L 5.5L 7.5L  
Straight type poultry drinker is made of super quality plastic With UV additive  
Professional design with galvanized hanging  
Transferable design easy for wash



**KD 635 禽用饮水器**  
Auto drinker  
Straight type poultry drinker is made of super quality plastic With UV additive  
Professional design with galvanized hanging  
Transferable design easy for wash



**KD 636 禽用饮水器**  
Auto drinker Type-B  
Straight type poultry drinker is made of super quality plastic With UV additive  
Professional design with galvanized hanging  
Transferable design easy for wash



**KD 637 塑料蛋托-A型**  
Plastic egg tray A-Type  
规格/Specs 30pcs  
made of super quality plastic with UV additive  
kinds of color is available



**KD 638 塑料蛋托-B型**  
Plastic egg tray B-Type  
规格/Specs 30pcs  
made of super quality plastic with UV additive  
kinds of color is available

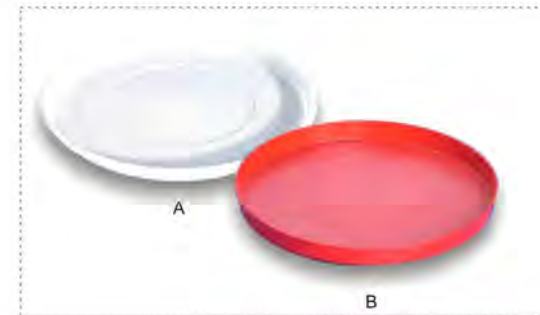

**KD 639 开食盘**  
Plastic Feeding Plate  
A-规格/Size  $\Phi 295 \times 25 \text{mm}$   
 $\Phi 380 \times 25 \text{mm}$   
B-规格/Size  $\Phi 330 \times 35 \text{mm}$   
 $\Phi 405 \times 35 \text{mm}$   
made of super quality plastic with UV additive  
kinds of color is available



KD640 开食盘  
Plastic Feeding Plate  
A-规格/Size 545x350x43mm  
B-规格/Size 450x450x45mm  
made of super quality plastic  
with UV additive  
kinds of color is available



KD 650 塑料鸡笼  
Autolock Cage for Poultry  
规格/Size:750\*550\*270  
750\*550\*290  
750\*550\*330  
made of super quality plastic  
with UV additive  
kinds of color is available



KD923 Milk Bottle 奶壶  
Size: 1L、2L、2.5L、  
3L、5L  
Made of nontoxic plastic material  
with feeding teat,used for livestock  
KD923 screw type teat feeding bottle  
KD923B slip type teat feeding bottle



KD965 喂药壶  
Oral Calf Drencher  
规格/Size : 4L  
made of nontoxic plastic material  
Easy to help animals with dehydration and diarrhea



KD960 喂奶桶  
Feeding bucket  
规格/Size: 8L  
made of nontoxic plastic material  
The teat can be replaced, used for lamb, calf;  
Bucket with scale;  
Bucket with handle;  
teat valve fixed teat,Control milk reflux, omission;



KD961 饲喂桶  
Feeding bucket  
规格/Size: 8L  
made of nontoxic plastic material, smoothinside and  
outside,  
Easy to clean, ageing resistance, corrosion resistance  
With acid, alkali resistant, high temperature resistant,  
non-toxic, sterile, tasteless



KD716 奶嘴  
Nipple  
Made of soft latex rubber  
A ball valve allows air inlet to the bottle  
real rubber teat to fit most soda bottles



KD924 测试板  
Mastitis Super Paddle  
Used for testing the milk of cow and to check  
the mastitis of cow  
Made from robust plastic and can be ordered  
in black or white .  
To shorten the time of testing,and draw a conclusion  
in three minutes



KD921 羊毛剪  
Wool shear A-Type  
Smallest size B&B shear,ideal for dagging and  
trimming of lambs  
Also very useful for any clipping work on other  
animals—dogs,cows,horses.



KD921-B 羊毛剪  
Wool shear B-Type  
Size: 300mm or 330mm  
Also very useful for any clipping work on other  
animals—dogs,cows,horses.



**KD701-A 全自动家禽切嘴机**  
Full-automatic Debeaker  
Quickly cut chicken beak by full automatically  
Blade is made of Germany's stainless steel  
Stanch blood for chicken with different ages  
Voltage applicable: 220V or 110V  
Power consumption: 200-250W  
Temperature of movable knife: ;600-800°C



**KD701-B 脚踏式切嘴机**  
Manual Debeaker (Pedal)  
Quickly cut chicken beak by feet  
Stanch blood for chicken with different ages  
Voltage applicable: 220V or 110V  
Power consumption: 200-250W  
Temperature of movable knife: ;600-800°C



**KD701-C 手动切嘴机**  
Manual Debeaker  
Quickly cut chicken beak by hand  
Brass material  
Stanch blood for chicken with different ages  
Voltage applicable: 220V or 110V  
Power consumption: 200-250W  
Temperature of movable knife: ;600-800°C



**KD702 电动羊毛剪**  
Sheep Clipper  
Delivered in a carrying case and with comb and cutter  
Light and easy to handle  
Power:350W,Speed:2600Rpm,Frequency:50/602Hz  
Voltage :110V/220V



**KD750 狗用剪毛器**  
Dog Clipper  
Delivered in a carrying case and with comb and cutter  
Light and easy to handle  
Power:12W  
Voltage :110V/220V



**KD705 兽用无血去势器A型 (碳钢)**  
Castrating Device A-Type  
Specs: 36cm 51cm Carbon steel  
High quality castration tools.For use only by experienced herdsmen  
Or under the supervision of a veterinarian.  
Dimensions are length,and jaw width.  
Supplied complete with service spanner.  
36cm/51cm carbon steel



**KD706 兽用无血去势器B型 (不锈钢)**  
Castrating Device B-Type  
Specs: 46cm 36cm Stainless steel  
High quality castration tools.For use only by experienced herdsmen  
Or under the supervision of a veterinarian.  
Dimensions are length,and jaw width.  
Supplied complete with service spanner.  
36cm/46cm Stainless steel



**KD707 羊用去势器C型 (不锈钢)**  
Articulated Castrator C-Type  
Specs: 23cm,Stainless steel  
High quality castration tools.For use only by experienced herdsmen  
Or under the supervision of a veterinarian.  
Dimensions are length,and jaw width.  
Supplied complete with service spanner.  
23cm Stainless steel



**KD708 牛鼻钳 (A碳钢、B不锈钢)**  
Bull Holder With Chain A-type  
Specs:20cm  
This design features a chain closure,and lockinghook,for quick and easy action  
In all conditions.  
Chain is 40cm long,with large end-link for attachment of rope  
A: Carbon steel B: Stainless steel

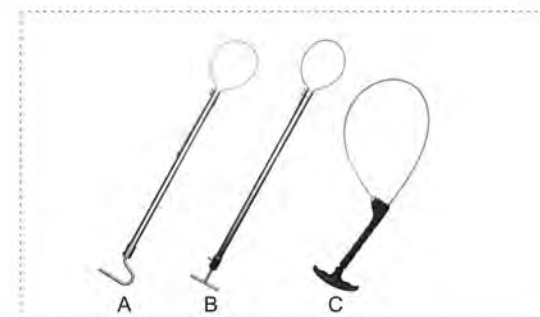

**KD735 保定器**  
Pig Holder  
"S" or "T" Shape handle  
It' s made of stainless steel pipe  
Strong steel string with PVC with coating protecting animals hurting  
Professional locker design easy for operation  
A Type stainless steel pig holder with locker( "S" handle)  
B Type stainless steel pig holder with locker( "T" handle)  
C Type economy pig holder



**KD710 电热断尾器 (220V, 110V)**  
Electromotion Cutter (220V,110V)  
The main purpose of cutting tail is preventing piglets from biting their tails each other  
Sharp blade  
Durable and Good thermal conductivity  
Thickened Heating wire  
Voltage :110V/220V



**KD711 扩张钳 (塑钢、锌合金)**  
Elastrator Stretching Forceps  
(Plastic steel, Zinc alloy)  
A Type Plastic steel  
The applicator is especially suitable for the breeder with a small number of animals to dock or castrate.It is a perfectly satisfactory tool at a very low price.No need to pay more if you need more.pins open to 45mm\*40mm\*34mm(sides)  
B Type Zinc alloy  
Applicators are made in many places in many different qualities.ours is high quality at low price,guaranteed to give very good service.Smooth and easy operation. pins open to 50mm\*40mm\*30mm(sides)



**KD922 去势圈**  
Castrating bands  
Silicon material  
Strong,nontoxic  
Applied with castrating band applicator



**KD713 不锈钢剪牙钳**  
Stainless Steel Tooth-Cutter  
Piglet tooth cutter is made of hard alloy steel 4cv14  
With spring sheet  
Hardness of blade 56-58HRC



**KD714 仔猪断尾钳**  
Pocking Tail Cutter  
Knives are made of hard alloy steel  
Sandy handle is made of soft plastic  
Metal lock part easy for operation



**KD715 宠物指甲钳**  
Nail Clipper For Pets  
Material:steel with zinc or chrome plated  
With rubber handle



**KD717 牛胃取铁器**  
Cattle Stomach Suction-Iron Device  
Protect the Bull's esophagus and mouth  
Convenient disassembly and assembly  
Adsorption force  $\geq 5$  kg  
3-year warranty

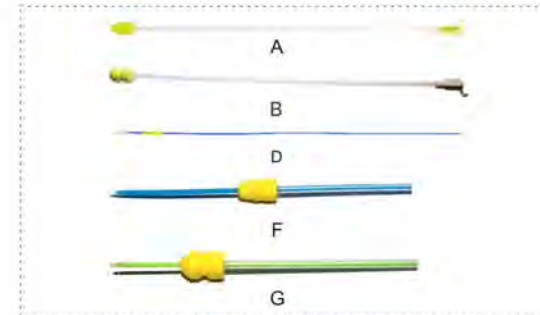

**KD718 Catheter 输精管**  
Specs: A-Type B-Type  
D-Type E-Type  
F-Type G-Type  
Product: Deep insemination catheter with lock  
Model: Multiparity/ Primiparity  
Packing: 100pcs/bag , 10bags/carton  
Color: yellow foam  
Size: 80cm



**KD 719 输精瓶**  
Semen bottle  
Specs: 80ml 100ml  
Semen bottle is made of food grade material  
Scale on body easy for checking  
Color of cap is available  
Size: 80ml 100ml



**KD725 赶猪拍**  
Pig Paddle with short handle  
or Short Handle  
Consist of a hollow 30cm x 16cm paddle  
With noise-making beads inside  
Lightweight, highly visible and noisy  
Nice soft rubber grip or TPR grip  
Color of paddle is available  
Size: 75cm 107cm 122cm



**KD727 挡猪板**  
Pig herding board  
HDPE material  
Ideal for weaners to market-ready pigs  
Also ideal for fully grown sows or boars  
Size: L (120×76CM) M(94×76CM) L(76×46CM)



**KD930 猪用输精夹**  
Artificial Insemination holder  
Made of high quality plastic  
With light weight and easy to use  
Flexible and adjustable  
Hold the flank of sow, improve the absorption of semen by sow



**KD930-B 猪用输精夹B型**  
Artificial Insemination holder B-Type  
Made of high quality plastic  
With light weight and easy to use  
Flexible and adjustable  
Hold the flank of sow, improve the absorption of semen by sow



**KD703 大动物输精枪**  
Veterinary Semen Deposition Gun  
Specs: 0.25ml 0.5ml  
Made by high quality stainless steel  
It can be used in straw semen AI and there are three specifications of 0.25ml, 0.5ml and universal.  
Its special is to lock sheath by a wire lock and easy to lock and unlock sheath.



**KD704 禽用输精枪**  
Semen Deposition (For Poultry)  
规格/Specs: 1ml 2ml  
For Poultry and Rabbit use  
Continuous insemination  
Adjustable insemination dosage, can be used on 40-50pcs in once time  
Increase the fertilisation rate by 3% to 5%  
Save semen by 20%-30%



**KD813 连体衣服**  
Veterinary Overall  
30% EVA plus 70% LDPE  
Super sensitive, flexibility and strong in using, it could hold 1L water pressure testing  
25pcs per OPP bag  
Factory direct price and OEM color design available



**KD814 长臂手套**  
Veterinary Shoulder Protect Glove  
125cm Length, link with neck and 12g in weight  
30% EVA plus 70% LDPE  
Super sensitive, flexibility and strong in using, it could hold 1L water pressure testing  
50pcs gloves per dispenser box, blue color box or neutral white box available  
Factory direct price and OEM color design available



**KD815 长臂手套**  
Long Glove (90cm)  
90cm Length, 8g in weight or 7g in weight for choice  
30% EVA plus 70% LDPE  
Super sensitive, flexibility and strong in using, it could hold 1L water pressure testing  
100pcs gloves per dispenser box, blue color box or neutral white box available  
Factory direct price and OEM color design available



**KD816 长臂手套带橡皮筋**  
Veterinary Glove With Strap  
90cm Length  
Comfortable to wear  
30% EVA plus 70% LDPE  
Super sensitive, flexibility and strong in using, it could hold 1L water pressure testing  
100pcs gloves per dispenser box, blue color box or neutral white box available  
Factory direct price and OEM color design available



**KD818 一次性鞋套**  
Disposable Over Boot  
\*Material: EVA+PE  
\*Color: White  
\*Thickness: 0.07mm, size: 45×45cm, N/W: 16G  
0.12mm, size: 45×45cm, N/W: 28G



**KD730 体重尺**  
Weight bands  
Tape placed in a plastic casing  
The tape(1.50m/5.05ft) coils up automatically with a push button  
Metric and inch double unit  
OEM printing is favorable  
Weight&Length measuring



**KED912 绷带 Bandage**  
Excellent tear resistance, shock-absorbing under strenuous activity, firm support, non-slip  
When applied correctly the bandage provides safe support without blocking the blood flow, easy to apply, even on difficult areas, suitable for all animals:  
Very porous lightweight bandage, barely perceptible, skin breathes while the wound is healing:  
Self-adhesive, therefore no grips, does not stick to the coat, easy to remove using bandage scissors, providing support, protection and security  
Size: 25 x 45mm 50 x 45mm 75 x 45mm 100 x 45mm  
color: different color is available  
packaging: 12 rolls in convenient sale box. OEM packaging is available



**KD820 宠物清洁按摩手套**  
Clean & Massage Glove  
Color: multi-color (custom)  
Function: remove the hair on the dog and cat, massage, bathing, promote blood circulation  
Professional pet glove, Factory Direct Sales, Quality Assurance



**KD807 (A)冷藏箱 (B)冷藏包**  
Ice Box  
Specs: 6L 12L  
Color: Blue  
Material: Plastic-pp liner, PU foam, HDPE  
Usage: Insulation, cold storage



**KD808 器械箱**  
Instruments Box  
Material: Aluminium alloy  
Size: Customize  
Character: Lightweight, durable&independent placement of apparatus



**KD801 手动喷雾器**  
Hand Sprayer  
Long-spraying head  
More flux,Hand atomizing  
Practical,safe and labor saving  
Reasonable design,simple and portable  
Suitable for garden and household cleaning  
Capacity:16L,18L,20L  
Working pressure:2-4 bar



**KD802 电动喷雾器**  
Electric Sprayer  
Long-spraying head  
More flux,Battery atomizing  
Practical,safe and labor saving  
Reasonable design,simple and portable  
Suitable for garden and household cleaning  
Capacity:16L,20L  
Working pressure:2-4 bar



**KD803 气压喷雾器A型**  
Air Pressure Sprayer A-Type  
Specs: 5L 6L 8L 10L  
Long-spraying head  
More flux,better atomizing  
Practical,safe and labor saving  
Reasonable design,simple and portable  
Suitable for garden and household cleaning  
Capacity:5L,6L,8L,10L  
Working pressure:2-3 bar



**KD804 气压喷雾器B型**  
Air Pressure Sprayer B-Type  
Specs : 1L 1.5L 2L  
Made of high quality new raw plastic  
Capacity:1L,1.5L,2L  
Prefect pump sprayer with off-stream-off function  
Print logo is available



KD805 手动喷雾器  
Hand Sprayer  
Specs:16L,18L,20L

Long-spraying head  
More flux,Hand atomizing  
Practical,safe and labor saving  
Reasonable design,simple and portable  
Suitable for garden and household cleaning  
Capacity:16L,18L,20L  
Working pressure:2-4 bar



KD806 手动喷雾器  
Hand Sprayer  
Specs:16L, 20L

Long-spraying head  
More flux,Hand atomizing  
Practical,safe and labor saving  
Reasonable design,simple and portable  
Suitable for garden and household cleaning  
Capacity:16L,20L  
Working pressure:2-4 bar



KD901 兽医听诊器  
Veterinary Stethoscope  
Specs: Single head/Dual-head

Anodized aluminium chestpiece  
Brass chrome plated binaural  
White plastic or soft material ear tips  
Y-PVC tube is assorted colors:black,yellow,red,pink,orange  
Silver plated head, standard PVC tubing;  
Comes complete with a clear multi pocket.  
Each set with one spare parts bag  
Color of tube is available



KD902 药浴杯  
Teat Cup (PVC)

As well as pre-dipping and post-dipping of teats at milking time to reduce mastitis infections, teat dip cups are very useful for treatment of black-pock and other teat lesions.



KD903 Cow Magnet 牛磁  
A:12.7mm\*76.2mm B: 19mm\*79.2mm  
C: 63.5mm\*15.8\*13mm D:100\*30\*28mm  
E:37mm\*100mm

Used worldwide as an effective remedy for hardware disease. Stronger Magnetization before assembly creates a consistent pulling force from each section along the length of the magnet and enhances its overall strength. Superior Characteristically, These qualities make it easier for the magnet to travel to the stomach and stay there. OEM packaging is available

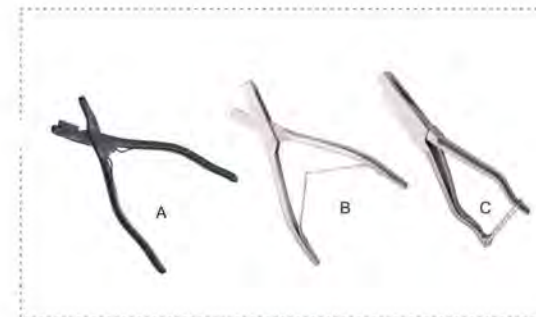

KD904 耳号打缺钳  
Ear-mark Notch A: Carbon steel  
B: Stainless steel(U type)  
C: Stainless steel(V type)

Suitable for full grown stock.  
Available as a V or U shape.  
Notch up to 22mm deep, 20mm wide at base.  
Comes with adjustable depth gauge.



KD905 修蹄刀  
Hoof knife

excellent quality hoof knives are made of high quality alloy steel, treated to reduce or prevent corrosion. Hardwood handle is securely riveted to the blade. These knives feature an extra-fine tip, ideal for exploration of holes in the hoof without creating a major excavation.

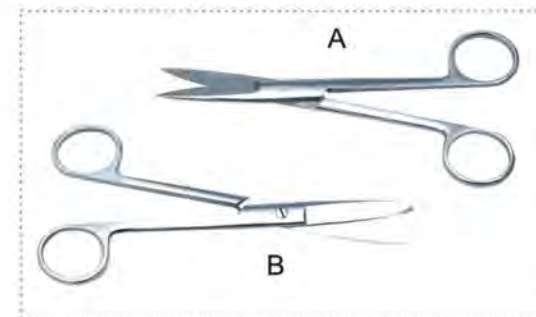

KD 906 手术剪  
Operation Scissors  
A-Type B-Type

The products meet mechanical design,easy to operation. Our products are made of high-quality stainless steel.

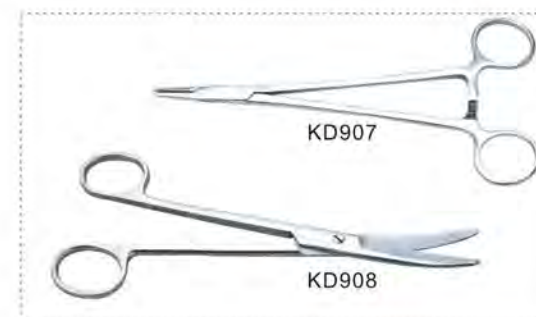

KD907 Needle Holder  
持针钳  
KD908 Bowel Scissors  
肠剪

The products meet mechanical design,easy to operation. Our products are made of high-quality stainless steel.





**KD940 饲料铲**  
Scoop  
Type-A  
Ice scoop is made of Aluminium  
serve for ice and dry good  
secure finger grip handle  
Type-B  
Kinds of color is available  
Somatological handle



**KD 950 输液器**  
Uterine-infusion-pipete-for-cattle  
yellow vial holder and tube is made of super quality latex,  
white clamp for easy adjusting the flux;  
brass+chrome plated connection  
luer lock adaptor with needle;  
each set with one neuter box, 100pcs per carton  
(OEM packaging is available)



**KD919 断奶器**  
Wean Calf Plastic  
Plastic weaner spurs calf weaner cow weaner cattle weaner  
Plastic weaner for cow calf  
It's easy to adjust the screw, can use again  
Avoid the mavericks suck behavior, avoid to spread the disease  
Used to prevent the calfs to suck the breast  
used to prevent calfs to lick bellybutton of each other



**KD925 牛鼻环**  
Bull Ring ( S/S )  
bull rings are made of brass.  
Long lasting, totally proven in use.  
Thumbscrew-type locking pin, broken off when  
tight, reveals cross-slot for screw driver.

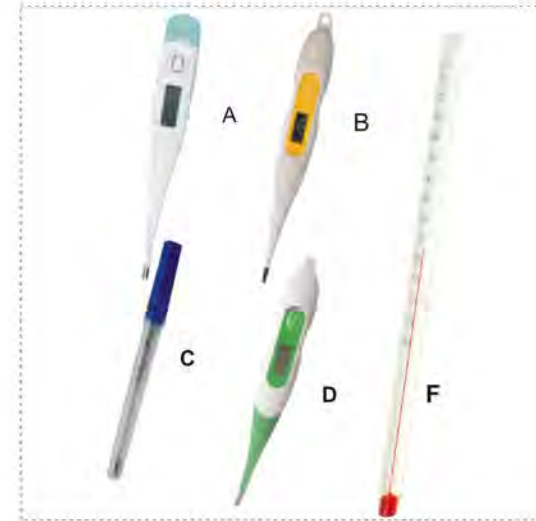

**KD913 兽用体温计**  
Veterinary Thermometer  
Flexible tip and fixed tip are all available;  
Range 90°F~109.9°F±.2°F or 32°C~43.9 °C ± .1°C depend on  
scale selection;  
Replaceable 1.55V type battery provides up to1500 measurement;  
Specially designed housing with lanyard attachment for enhanced  
removed;  
Integral carry case;  
Safe-Test Alarm/ Memory/ Beeper



**KD914 兽用红外测温仪**  
Veterinary Infrared Thermometer  
temperature measuring within 15 seconds.  
calibrated, max, tolerance of 0.1°C(32~42°C), 0.2F(89.6~107.6F),  
measuring range 32°C~42°C(89.6F~107.6)  
special design by ergonomic contoured shape for veterinary use  
four digit display for accurate temperature measurement  
instant conversion between celsius and Fahrenheit  
come with batteries, blister packaging



**KD918 红外线灯**  
Infrared Lamp  
Color: clear, red, blue, green, yellow  
waterproof, hard glass  
lifetime: 3500hrs  
accpt OEM  
Each piece with one polybag, then with one middle box,  
12boxes with one export carton

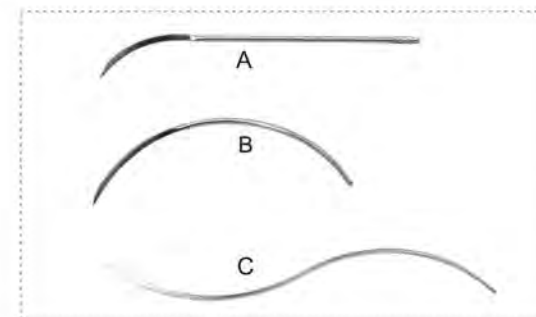

**KED 909 缝合针**  
Suture Needle  
Specs: A-Type B-Type C-Type  
Material: high quality stainless steel  
Needle shape: straight round shape, rectangular triangle shape,  
circular arc shape  
Validity: 2years

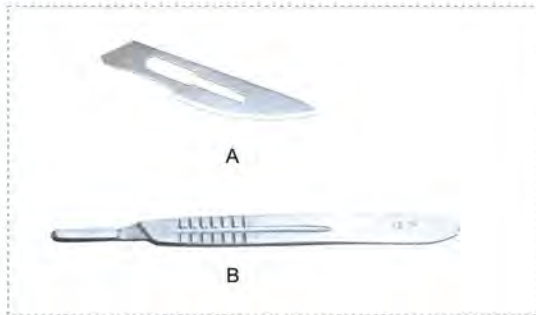

KED 910 手术刀片 刀柄  
A: Operating Blade  
B: Operating Scalpel Handle

Operating Blade Description:  
High quality surgical blade  
with full sizes to choose  
Operating Scalpel Handle Description:  
High quality surgical blade handle  
Use for handle surgical blade



KED 911 缝合线  
Suture (Silk,Catgut)  
Safe and non-toxic to human.  
Causes very slight tissue reaction, and help accelerate fibrous connective  
tissue in growth.  
Suitable for surgery.



KD1001 兽用B超  
B Mode Ultrasonic Diagnostic Instruments  
High resolution linear/convex ultrasound scanner  
Adopts micro-computer control and digital scan converter  
Video output and high speed USB PORT  
Jet moulding enclosure with hand-held structure  
Dimension: 7"



KD1002 生物显微镜  
Biological Microscope  
KD1002 series microscope is improved on the basis of KD1002 series such as adding  
anti-mould device and some decoration.  
It looks nice and much modern.  
Viewing Head Monocular Head Inclined at 45°, 360° Rotatable  
Sliding Binocular Head Inclined at 45°, 360° Rotatable; Anti-mould  
Compensation Free Binocular Head Inclined at 30°, 360° Rotatable; Anti-mould  
Trinocular Head for Photography Trinocular Head for Video Camera (C Mount)  
Eyepiece Wide Field Eyepiece WF10×, P16 ×  
Objective Achromatic Objective 4×、10×、40× ( S )、100×(S, Oil)  
Nosepiece Quadruple Nosepiece



KD1004 液氮罐  
Nitrogen Tank  
High-strength aluminum alloy structure, light empty weight  
Hinged handle (except YDS-5-200) is portable  
The lockable device can be installed to the container lid upon costumers' requirement  
so as to protect biological samples stored (limit for 30mm, 50mm、80mm calibers)  
Encoding system is applied on canisters for easy recognition and convenient accessing of  
samples  
More than 5-year vacuum quality guarantee is ensured with the multi-layer thermal  
isolation design



KD850 带蓄电池  
With Battery



KD851 可充电  
Rechargeable



KD852 可充电  
Rechargeable



KD853 带蓄电池  
With Battery



KD858 驱赶器拍杆  
Shaft  
规格/Description

- 41" Shaft(measures 52" with prod handle unit)
- 41" Shaft(measures 42" with prod handle unit)
- 41" Shaft(measures 36" with prod handle unit)
- 41" Shaft(measures 32" with prod handle unit)
- 41" Shaft(measures 22" with prod handle unit)



KED 2002 Poly Wire  
Blue, White & Black  
2white 1orange

3 strands 6 stainless steel 0.15mm diameter  
high quality polymers  
with UV additive  
250 meters per plastic spool  
color of strip is available



KED 2003 Poly Wire  
Orange & Silver

3 strands 6 stainless steel 0.15mm diameter  
high quality polymers  
with UV additive  
250 meters per plastic spool  
color of strip is available

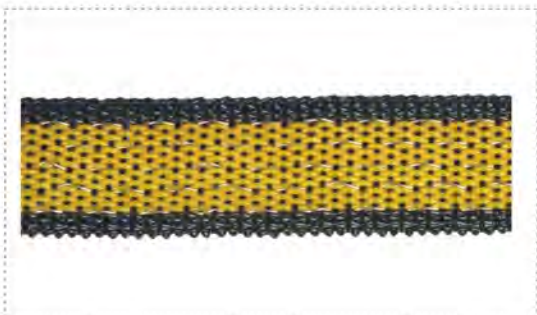

KED 2001 Poly Tape  
Yellow black

made of good quality polymers  
with UV additive  
color of strip for maximum all season visibility  
livestock are controlled easily  
suitable for all fence insulators  
250 meters per plastic spool

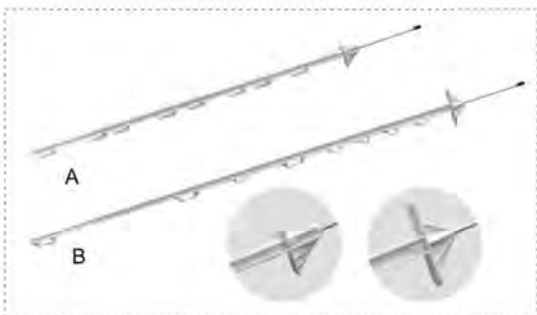

KD3001 Plastic post  
A: 100cm B: 150cm

The tread in posts is PP material with UV resistance treatment, which makes the post for long life.  
Total length 120cm, 100cm above-ground and 20cm underground.  
Dia 8mm\*20cm spike with rust resistance galvanised.  
The reinforced ribs designed foot make the post especially strong, and the sharp spike help fencing easy. Just step in, no need to use any tool.  
Easy to stall and easy to remove. The best way for your fence.  
Eight quality holders can hold up to 50mm polytape and all sizes of ropes.  
The PP material has good flexibility, the post can keep belding but without break.  
Low costs but high efficient, easy for installing and removing. It is the best way for your fence.



KD 3038  
Wheel Plastic Steel Insulator

for attaching rope products to wood posts and trees  
allow for easy entry of conductor into smooth channel  
prevents the possibility of hte conductor escaping from the insulator  
it's made of nylon with UV additive  
self-screw with zinc plated, easy for entry  
packaging 50pcs per polybag



KED 3050  
Spring for Door Handle

With positive non-slip grip  
high tensile galvanized spring  
works with high tensile wire  
polywire or a replacement handle for patriot spring gate  
in permanent



KD3006  
Anchor insulator

for attaching rope products to wood posts and trees  
allow for easy entry of conductor into smooth channel  
prevents the possibility of the conductor escaping from the insulator  
it's made of nylon with UV additive  
self-screw with zinc plated, easy for entry  
packaging 50pcs per polybag



KD3015  
Ring insulator with screw

Specs: All-round meat support,  
Screw length: 88mm  
for attaching rope products to wood posts and trees  
allow for easy entry of conductor into smooth channel  
prevents the possibility of hte conductor escaping from the insulator  
it's made of nylon with UV additive  
self-screw with zinc plated, easy for entry  
packaging 50pcs per polybag



KD3026  
Screw-tight insulator  
for round post up to  $\phi$  16mm  
Specs: Size for tape upto 40mm,  
for rope upto  $\phi$  16mm



KD3061  
insulator  
It's Made Of Nylon With Uv Additive



KED5001  
①DOG LEAD WITH FOAM HANDLE  
KED1003-A 1.6mm×48"  
KED1003-B 2.0mm×48"  
KED1003-C 2.5mm×48"  
KED1003-D 3.0mm×48"  
KED1003-E 3.5mm×48"  
KED1003-F 4.0mm×48"  
  
②DOG LEAD WITHOUT HANDLE  
KED1001-A 1.6mm×40"  
KED1001-B 2.0mm×40"  
KED1001-C 2.5mm×40"  
KED1001-D 3.0mm×40"  
KED1001-E 3.5mm×40"  
KED1001-F 4.0mm×40"



KED5006  
Nylon Collar  
Material: high quality nylon  
With foam pad, zinc alloy metal fasteners  
Colors are available  
Size:1.5cm\*48";2.0cm\*48";2.5cm\*48"



KD 5007  
Nylon Collar  
Material: high quality nylon  
With foam pad, zinc alloy metal fasteners  
Colors are available  
Size:15mm\*400mm/20mm\*500mm/ 25mm\*600mm



KED4002  
Bone 15\*5\*4.5  
  
Get every puppy chew toy you need in one bundle  
Puppy Starter Pack: Includes puppy teething bone, chicken puppy chew toy, and a bacon puppy treat to cover every chewing stage  
Teething Pacifier: Natural rubber puppy toy that massages the gums and helps relieve teething pain  
Dental Dino: Chew toy for puppies that helps relieve teething pain with raised nubs and fun T-Rex shape  
Teething Rings: Fun, textured puppy chew toy that massages the gums and helps relieve teething pain



KED4004  
Christmas penguins  
11.5\*7.5



KED4005  
Hot dog  
13.7\*3.7\*3.0  
  
Made of soft rubber.  
Non-toxic material is used.  
The most suitable for pets and owners to play with, but also through the bite rubber pet can help healthy development of the teeth.



KED4006  
Valentines gift  
8\*7\*5  
  
The perfect accompaniment to any game of fetch.  
Excellent squeaky sound toys for dogs.  
Made of durable material.