



AKTUNING
PRODUCT CATALOG
2018



ZHONGSHAN AOKAI AUTO PARTS MANUFACTURING CO.,LTD

TEL:+86-760-22289997 22279995

FAX:+86-760-22287088 E-mail:ak@aktuning.cn

WEB:www.aktuning.cn

WWW.AKTUNING.CN

AKTUNING COMPANY PROFILE

Established in 2008, located in Xiaolan Town, Zhongshan City, Guangdong Province, China. Zhongshan Aokai Auto Parts Manufacturing Co., Ltd is a manufacturer specializing in designing, manufacturing and selling all kinds of car parts and accessories.

Our company covers an area of about 20,000 square meters, having more than 350 employees, owning our brand **AKTUNING** and **AK改裝**, mainly manufacturing carbon fiber series, racing steering wheel and other tuning accessories. Strong techniques support, advanced machines, standardized management system, improved after-sale service support our strong production output to USA, Europe, Japan and Middle East and other countries. Additionally, we are able to offer OEM service to meet clients' special requests. Our principle of client-orientation and integrity-first are highly praised by our domestic and overseas customers.

Aokai company focuses on product development and innovation, combining with market needs, in order to design new products to match the market. At the same time, Annually we will attend internationally and domestically well-known exhibitions, such as Canton Fair, Automechanika, SEMA show. Through industry exhibitions and Internet, our latest products will be displayed to show our competitiveness and to satisfy higher demands in car industry.

As a continually growing company, Aokai will go on offering high-performance, high-quality car parts and accessories. Not only it is our job, but our motivation as well.



CONTENTS

- 1-09**
SPOILER
- 10-14**
MIRROR COVER
- 15-19**
**REAR BUMPER LIP
WINDOW LOURVE**
- 20-21**
**BUMPER LIP DIFFUSER
WINDOW VISOR**
- 22-23**
**ENGINE COVER
CARBON FIBER KEY CASE/RING**
- 24-28**
LICENSE PLATE FRAME

AOKAI 2018 EXHIBITION SCHEDULE

- 1** 4-6th March, 2018 The 26th CIAACE Beijing
- 2** 11-14th April, 2018 The 13rd TAIPEI AMPA (Booth No. L1109)
- 3** 15-19th April, 2018 The 123rd Canton Fair (Booth No. 6.1D31-32)
- 4** 4.5-7th June, 2018 Automechanika Birmingham
- 5** 4.11-15th September, 2018 Automechnika Frankfurt
- 6** 4.15-19th October, 2018 The 124th Canton Fair
- 7** 4.29th October - 2nd November, 2018 AAPEX Show
- 8** 4.30th October - 2nd November, 2018 Sema Show
- 9** 4.28th November - 1st December, 2018 Automechanika Shanghai

CAR SPOILER WING

- CF CARBON FIBER
- ABS BLACK
- PU DOTTED BLACK
- FCF FAKE CARBON FIBER(CARBON TEXTURE)
- WT WATER PRINT CARBON LOOK



UNIVERSAL CAR SPOILER WING

AK-WY6803CF



- CF
- PU
- ABS

AK-WY6801CF



- CF
- PU
- ABS

AK-WY6802CF



- CF
- PU
- ABS

AK-WY6811CF

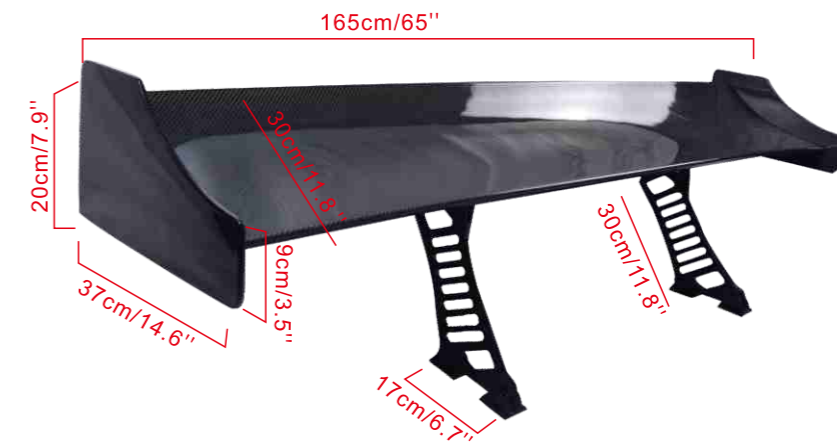

- CF



ROOF & TRUNK SPOILER
SPOILER



AK-WY6103CF



Trunk Spoiler
BM5 F10 F18



AK-WY6104CF



Trunk Spoiler
BM4 F32



AK-WY6201CF



Trunk Spoiler
E Class W207 2DR Standard E260



AK-WY6202CF



Trunk Spoiler
C Class W205 4DR (C180L\C200L\C220\C400) after 2014



AK-WY6105CF



Trunk Spoiler
BM3 F30 F35



AK-6115CF



Trunk Spoiler
BM F82(M4)



AK-WY6203CF



Trunk Spoiler
S Class W222 (S320/S400/S500/S600/S63) after 2013



AK-WY6204CF



Trunk Spoiler
C Class W204(C200) 2007~2013



AK-WY6107CF



Trunk Spoiler
BM X4 F26 after 2014



AK-WY6108CF



Trunk Spoiler
BM3 E92 2DR Standard 2005~2012



AK-WY6205CF



Trunk Spoiler
E Class W207 4DR Standard E260



AK-6208CF



Trunk Spoiler
C Class W205 2DR



AK-WY6116CF



Trunk Spoiler
BM X6 F16 2014~2017



AK-WY6133CF



Trunk Spoiler
BM 3 F30 2012~2017



AK-6406CF



Trunk Spoiler
Accord Euro-R (CL7)/2003



AK-WY7401CF



Trunk Spoiler
Tesla Model S



AK-7101CF



Trunk Spoiler
Volkswagen CC



AK-7102CF



Trunk Spoiler
Volkswagen CC 2010



AK-WY7304



Trunk Spoiler
15-17 SUBARU WRX STI



AK-WY6817



Roof Spoiler
2015-2016 SUBARU WRX STI



AK-6408CF



Roof Spoiler
10th HONDA 4dr CIVIC



AK-6409



Roof Spoiler
10th HONDA 4dr CIVIC



AK-6813



Roof Spoiler
MITSUBISHI LANCER



AK-6815A



Roof Spoiler
MITSUBISHI LANCER



AK-6407CF



Trunk Spoiler
10th HONDA 4dr CIVIC



AK-6412



Trunk Spoiler
10th HONDA 4dr CIVIC



AK-6814



Roof Spoiler
SUBARU LMPREZA 2002-2007



AK-WY7305



Roof Spoiler
SUBARU LMPREZA 1993-2001



AK-6814



Trunk Spoiler
96-00N HONDA CIVIC 2DR

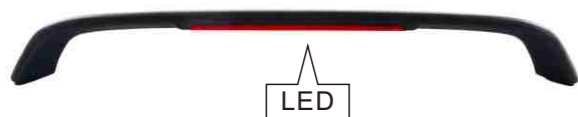

LED

AK-WY6410



Trunk Spoiler
CIVIC 2006-2011 FD2 TYPE



AK-WY6604



Roof Spoiler
2003-2006 INFINITI G35 2DR



AK-7201CF



Trunk Spoiler
2015-2017 FORD MUSTANG GT350R



Spoiler model

Model	Style	Model	Style
BMW		CL CLASS C215	trunk
1 SERIES E82	trunk	AUDI	
1 SERIESE87	roof/trunk	A3/S3 2014~2016	trunk
2 SERIES F22	roof/trunk	A4L/A4	roof/trunk
3 SERIES F30 F35	roof/trunk	A5	roof/trunk
3 SERIES E90 2005~2012	roof/trunk	A6L	roof/trunk
3 SERIES E92 2DR Standard 2005~2012	roof/trunk	Q3	trunk
3 SERIES E93	trunk	Q5	trunk
3 SERIES E46	roof/trunk	Q7	roof
3 SERIES E36	roof/trunk	TT	trunk
4 SERIES F32	trunk	HONDA	
5 SERIES F10 F18	roof/trunk	FIT 2014	trunk
5 SERIES E60 M-Tech	roof/trunk	CIVIC 2012	roof/trunk
5 SERIES GTHamann	trunk	CIVIC 2015	roof/trunk
5 SERIES E39	roof/trunk	CIVIC 2016	trunk
7 SERIES F01	roof/trunk	VEZEL	trunk
X1 SERIES	trunk	CRIDER 2013	trunk
X4 SERIES F26 after 2014	trunk	CITY 2014	trunk
X5 SERIES	trunk	ACCORD 2013~2014	trunk
X6 SERIES E71	trunk	SPIRIOR EURO	trunk
X6 SERIES F16	trunk	CRV 2012~2014	trunk
Z4 SERIES E89 HM	roof	CRV 2007~2011	trunk
Z4 SERIES E86	trunk	TOYOTA	
M2 SERIES F87 P	trunk	REIZ 2003~2009	trunk
M4 SERIES F82	trunk	REIZ 2010	trunk
M5 SERIES E60	trunk	COROLLA	trunk
M6 SERIES HM	roof/trunk	TEANA	trunk
M6 SERIES E63 2DR Standard	roof/trunk	CAMRY 2007~2012	trunk
MERCEDES BENZ		YARIS 2008~2012	trunk
A CLASS A10 A250	trunk	VIOS 2014	trunk
C CLASS W205 after 2014	trunk	FT86	trunk
C CLASS W204	roof/trunk	MAZDA	
C CLASS W205	trunk	M3 2011	trunk
E CLASS W207 2DR Standard E260	trunk	NISSAN	
E CLASS 4DR Standard E260	trunk	TEANA EURO 2008-2009	trunk
E CLASS W211	roof/trunk	INFINITI Q50L / 2014 - NOW	trunk
E CLASS W212	roof/trunk	VW	
E CLASS W210	roof/trunk	CC	trunk
E CLASS C207	roof/trunk	CC (2010-)	trunk
S CLASS W221	roof/trunk	FORD	
CLA CLASS CLA250	trunk	Mustang GT350R	trunk
CLK CLASS C209	roof/trunk	Mustang 2.3T	trunk
CLS CLASS C219	roof/trunk	SUBARU	
CLS CLASS C218	roof/trunk	SUBARU BRZ	trunk
R230 SL	trunk	TESLA	
		Tesla S OE	trunk



CAR MIRROR COVER

AK-BM89701CF Stick

BM 1 F20 F21
 BM 2 F22
 BM 3 F30 F31 F34 F35
 BM 4 F32 F33 F36
 BM X3



AK-BM89702CF Stick

FT-86



AK-BM89703CF Stick

BM X5 E70
 BM X6 E71 before 2013



AK-BM89704CF Stick

BM X3 F25
 BM X4 F26
 BM X5 F15
 BM X6 F16



AK-BM89705CF Stick

BM 5 F07GT F10 F18 F11 after 2010
BM 7 F01 F02 after 2008



AK-BM89706CF Stick

BM 5 F10 F18 F11 2010~2013



AK-BM89707CF Replace

BM 1 F20 F21
BM 2 F22
BM 3 F30 F31 F34 F35
BM 4 F32 F33 F36
BM X3



AK-BM89710CF Stick

BM3
BM4



AK-BM89713CF Replace

BM 1 F20 F21
BM 2 F22
BM 3 F30 F31 F34 F35
BM 4 F32 F33 F36
BM X3



AK-89715 Replace

Mercedes W204 A/B/C/E Class/GLK



AK-89717 Replace

VW Passat/CC (12-17)



AK-89716 Replace

Subare Land Raver Sport (13-17)



AK-89718 Replace

VW Golf 7 (13-17)



MIRROR COVER

AK-89719 Replace

Audi TT (15-18)



AK-89720 Replace

Audi A4L (13-16)
A5 (10-16)



AK-89714ABS Stick

Civic 2015+



AK-2631 Stick

Ford Focus
2008~2012



MIRROR COVER

AK-BM89711ACF Stick



AK-BM89711BCF Stick



CAR MODEL	TYPE
BMW	
1 SERIES F20 F21 2 SERIES F22 3 SERIES F30 F31 F34 F35 4 SERIES F32 F33 F36 X3 SERIES	stick/replace
X5 SERIES E70 X6 SERIES E71 before 2013	stick
X3 SERIES F25/X4 SERIES F26 X5 SERIES F15/X6 SERIES F16	stick
5 SERIES F07GT/F10/F18/F11 after 2010 7 SERIES F01/F02 after 2008	stick
5 SERIES F10/F18/F11 2010~2013	stick
6 SERIES F12	stick
M3 SERIES F80 M4 SERIES F82	stick
3 SERIES E92 2007~2013	stick
3 SERIES E92 M3 2007~2013	stick
3 SERIES E90	stick
3 SERIES E90 LCI	stick
5 SERIES F10 M5	stick
5 SERIES E60	stick
1SERIES E82	stick
1 SERIES E87	stick
3 SERIES E46 1998~2001	stick
Z4 SERIES E85	stick
MERCEDES BENZ	
A CLASS W176/A180/A200/A260/A45	stick
B CLASS W246	stick
C CLASS W204/W212/W221/W216	stick/replace
C CLASS W205	stick

E CLASS C207/E260/E350	stick
G CLASS W166	stick
G CLASS G55 G500 GL ML W166	stick
G CLASS GL350 GL400 GL500	stick
S CLASS W220	stick
S GLASS W222	stick
CLS CLASS W218	stick
GLA CLASS W117	stick
GLK CLASS GK260/GLK300	stick
AUDI	
A3 S3 RS3 8V	stick
A4 GT/A6 CT	stick
A6L C7	stick
A7 2012	stick
B9 A4 /A4L /A3 /A5 /S5/ RS3	stick/replace
Q5	stick
R8 TT/TTS	stick/replace
PORSCHE	
CARRERA 911/997 TURBO	stick
MACAN 2011~2016	stick
CAYENNE 958	stick
CAYENNE 2015	stick
FORD	
Ford Focus 2008~2012	stick
KUGA 2013	stick
MUSTANG 2015	stick
VOLKSWAGEN	
GOLF7 Bi 2013 after	stick/replace
BORA 2013	stick
MAGTAN 2012	stick/replace
Passat/CC(2012-2017)	stick/replace



REAR BUMPER LIP

AK-2646

Infiniti Q50L

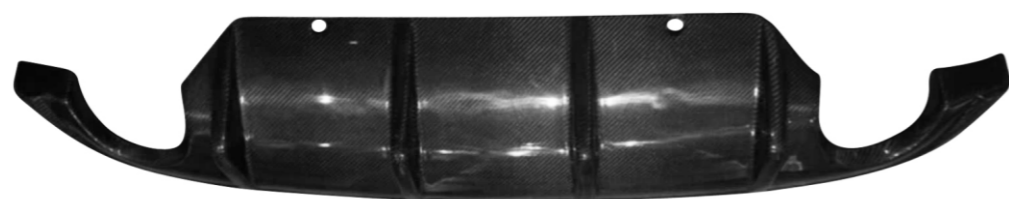

AK-7801

Honda Civic 2015-on



AK-7802

Toyota Reiz 2.5v 13-17



AK-7803CF

Honda Civic 2015-on



FRONT BUMPER LIP DIFFUSER

AK-2605CF

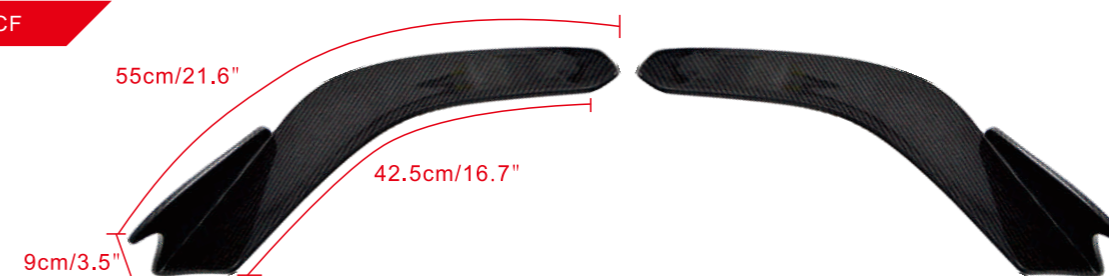

AK-2606CF



AK-2608CF

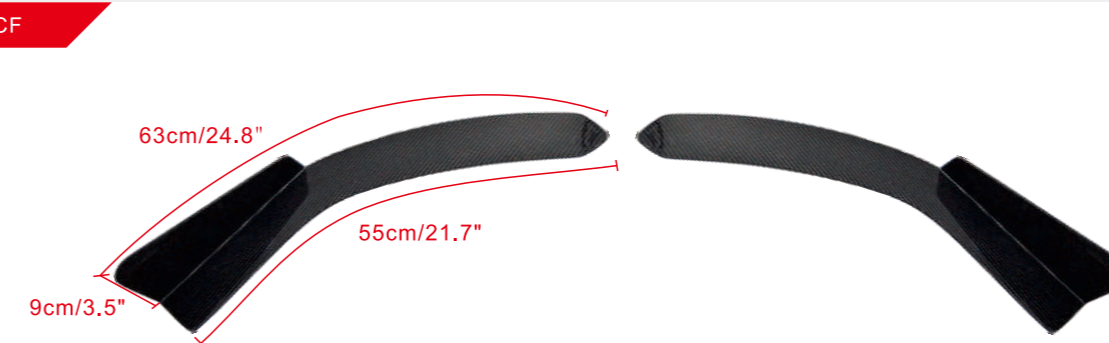

AK-2609CF



FRONT BUMPER LIP

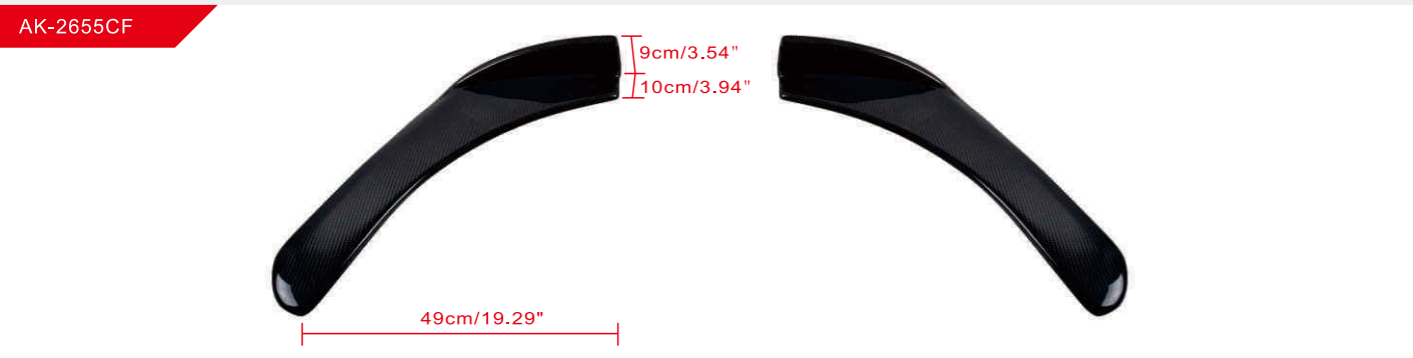
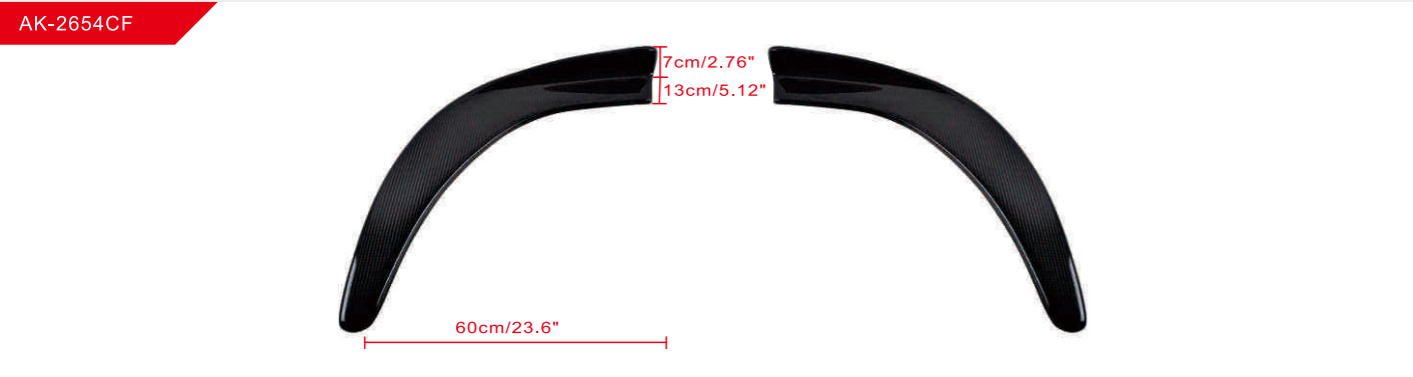
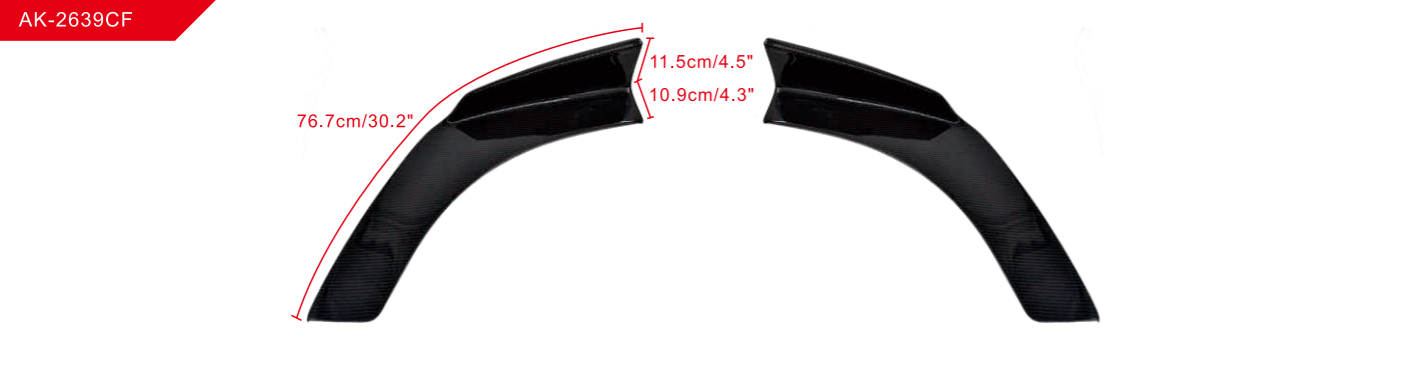
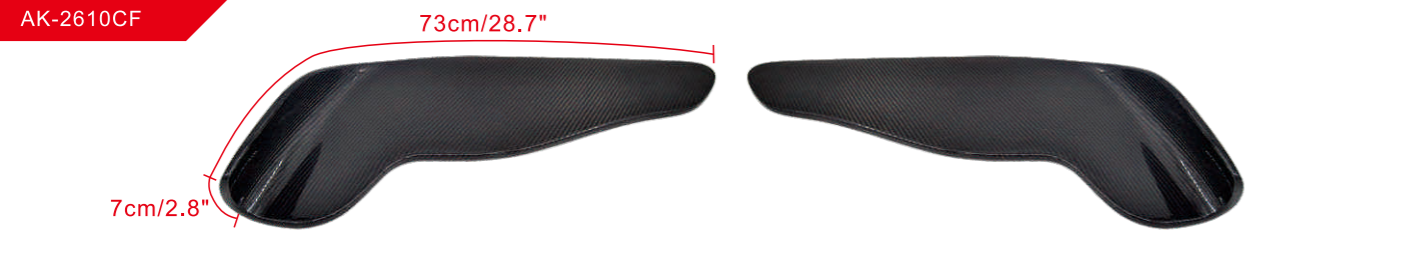

REAR /SIDE WINDOW LOURVE





- carbon look
- black
- carbon fiber

Vintage & Sporty style

AK-2672

Subaru WRX 2015-2016



AK-2673

Ford Mustang 1/4 Quarter 2005-2014



AK-2675

Honda Civic 2015-on



AK-2676

Honda Civic 2015-on



AK-2677

Ford Mustang 2015-on



AK-2678

Ford Mustang 2015-on



FRONT BUMPER LIP DIFFUSER

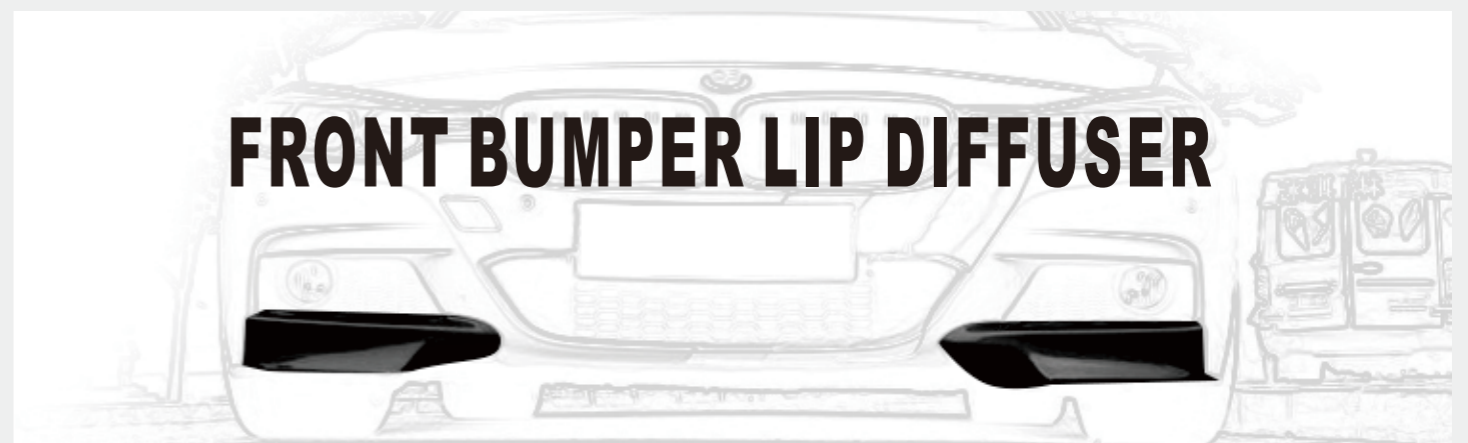

AK-2642CF

BMW E46



AK-2643CF

BMW E90 E91 2005~2008

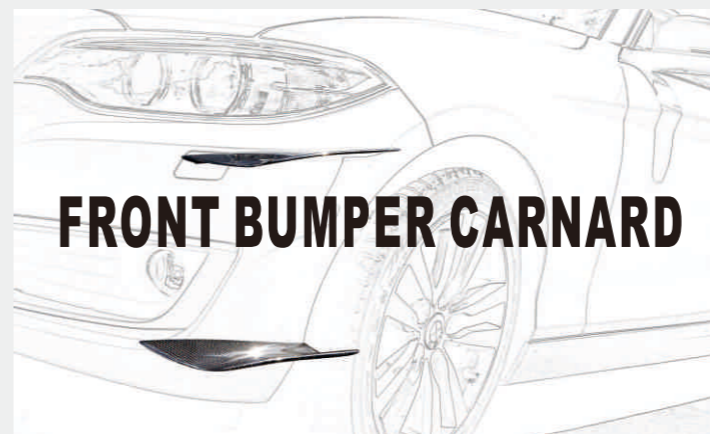

FRONT BUMPER CARNARD

AK-2689



AK-2625CF

40*12cm



AK-2626CF

36.5*13cm



AK-2652CF

32.5*6.5cm



AK-6903



CARBON FIBER WINDOW VISOR

CAR MODEL	PCS	CAR MODEL	PCS
BMW		HONDA	
3 SERIES F30 F35	4PCS	CIVIC	4PCS
5 SERIES F10 F18	4PCS	ACCORD	4PCS
5 SERIES GT HM	4PCS	AUDI	
M4 SERIES F82	4PCS	TT	2PCS
M6 SERIES HM	4PCS	A4/A4L	4PCS
X4 SERIES F26	4PCS	A5	4PCS
X5 SERIES	4PCS	A6L	4PCS
X6 SERIES	4PCS	FORD	
MERCEDES BENZ		MUSTANG	2PCS
C CLASS W 204	4PCS	MITSUBISHI	
CLASS W 207 2DR STANDARD E260	2PCS	EVO	4PCS
E CLASS 4DR STANDARD E260	4PCS	SUBARU	
S CLASS W 221	4PCS	BRZ	2PCS
CLS CLASS C218	4PCS	LEGACY	4PCS
TOYOTA		IMPREZA WRX STI	4PCS
FR-S 86	2PCS	TESLA	
PRIUS	4PCS	MODEL 3	4PCS
CAMRY	4PCS	MODEL X	4PCS
COROLLA	4PCS	MODEL S	4PCS
NISSAN		VW	
INFINITI Q50L	4PCS	CC	4PCS

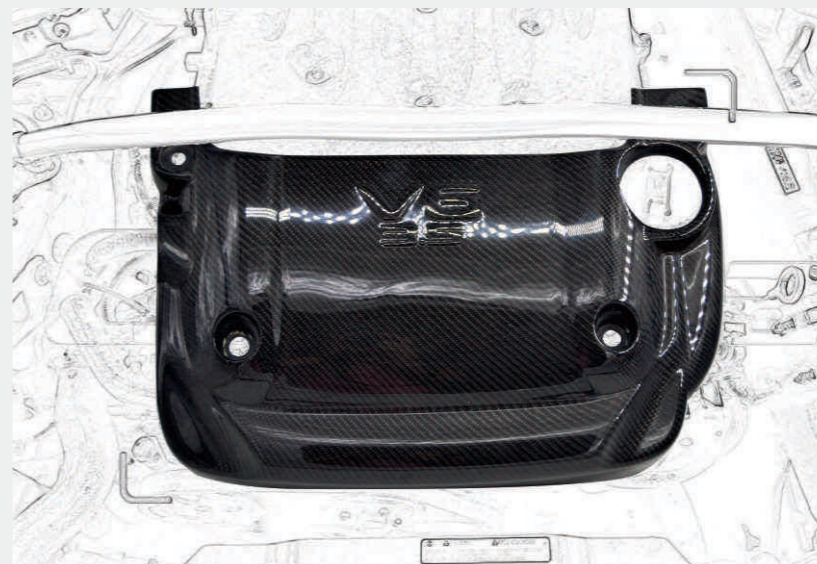

ENGINE COVER

CAR MODEL	TYPE
NISSAN 350Z 2003~2005	stick
NISSAN 370Z 2009~2012	stick
MITSUBISHI LANCER EVOLUTION EVO X EVO10	stick
BMW E60 2004~2008	stick
INFINITI G35 COUPE 2003~2007	stick
VW GOLF GTI MK5	stick
AUDI R8 V10	stick

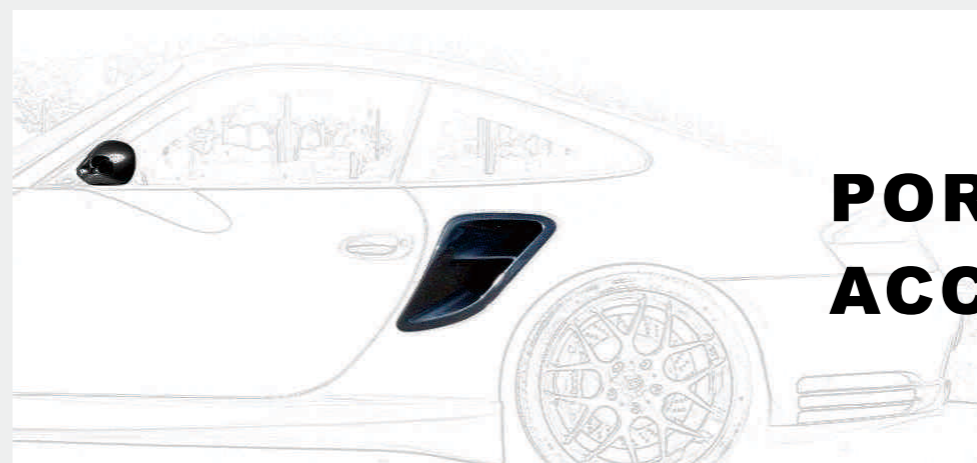

PORSCHE ACCESSORIES

AK-2640CF

PORSCHE CARRERA 911 997 TURBO



AK-2641CF

PORSCHE CARRERA 911 997 TURBO



CARBON FIBER KEY CASE/RING

AK-3999



AK-3908



AK-3904



Item No.	Car Model	Item No.	Car Model	Item No.
AK-3907	Porsche 911 /918 Cayenne /macan /panamera	AK-3915	Ford Mustang(CHINA)	AK-3927
AK-3921	Mercedes Benz E classE200L E300L	AK-3925	Cadillac XT5 A7S CTS CT6 SRX X7S SPX	AK-3930
AK-3903	Mercedes Benz A class / C class / S class /E class/ gla/ c200l	AK-3926	Lexus CT.IS.ES.GS.RX.GX	AK-3916
AK-3904	BMW	AK-3909	Lexus CT.IS.ES.GS.RX.GX	AK-3917
AK-3905	BMW x5 x6 x1 2014	AK-3902	Volkswagen Sagitar,Tiguan,Lavida, Bora,Passat,Golf	AK-3918
AK-3921	Jaguar XE XP XJ Land Rover Range Rover,Discovery, Evoque,Freelander	AK-3919	Volkswagen Golf7,Lamando	AK-3924
AK-3901	AUDI A4L,A8,A7,Q5,RS6, S6,RS5	AK-3928	JEEP	AK-3931
AK-3906	AUDI A1,A3,A4L,A6L,Q3, Q7,TT	AK-3929	Chevrolet Camaro Malibu	AK-3914
AK-3922	Ford Mustang(USA)	AK-3908	Infiniti Q70L,Q50,Q50L,QX50, QX70,JX35,G25	

LICENSE PLATE FRAME

AK-8304

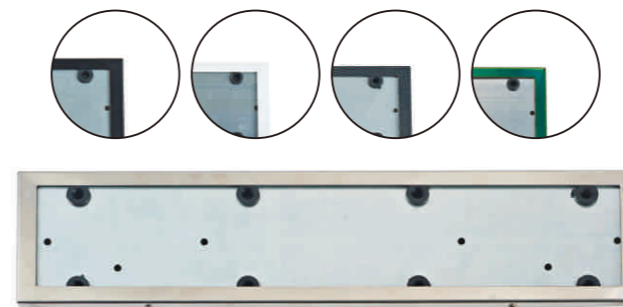

AK-8305



AK-8307



AK-8311



AK-8313



AK-8309



AK-8310



AK-8317



LICENSE PLATE FRAME

AK-8340

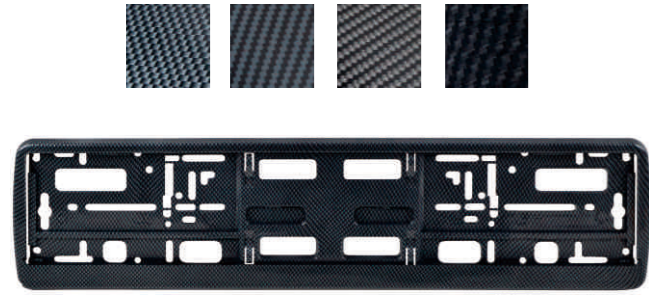

AK-8359

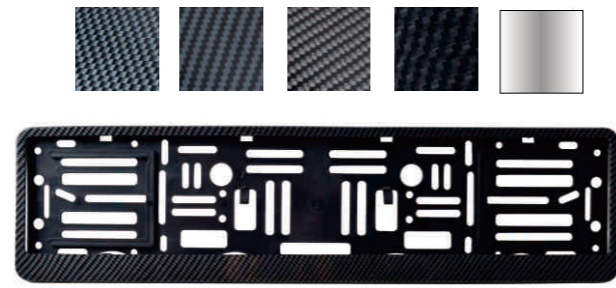

AK-8326

CHINA
CARBON FIBER



AK-8319

CHINA
CARBON FIBER



AK-8343WT

CHINA
CARBON LOOK

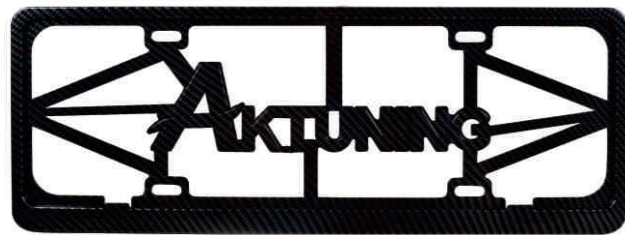

AK-8365

CHINA
CARBON FIBER



AK-8322

THAILAND
CARBON FIBER



AK-8353

THAILAND
CARBON LOOK



AK-8354

THAILAND
CARBON TEXTURE

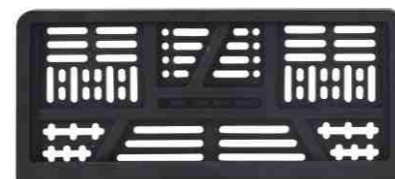

LICENSE PLATE FRAME

AK-8324A

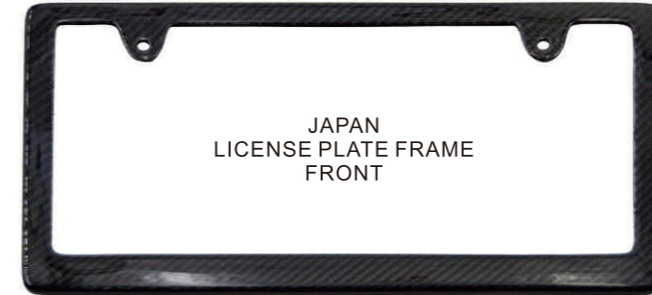

AK-8324B

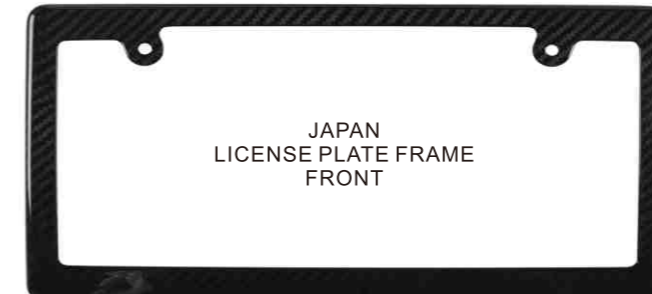

AK-8324C

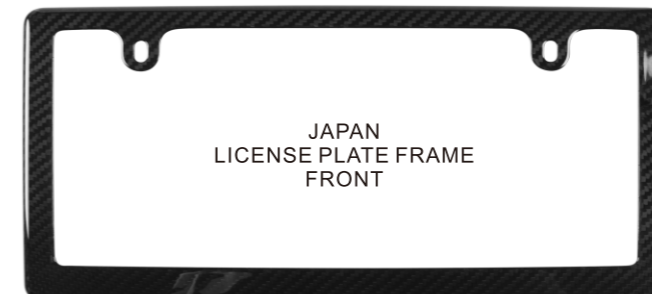

AK-8324D

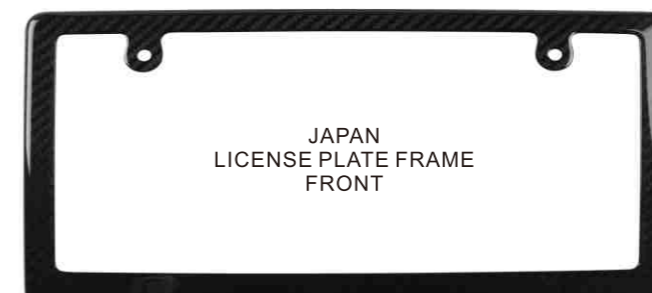

LICENSE PLATE FRAME

AK-8348

AMERICAN
CARBON LOOK & CARBON TEXTURE



AK-8314

AMERICAN
CARBON LOOK & CARBON TEXTURE



AK-8349

AMERICAN
CARBON LOOK & CARBON TEXTURE

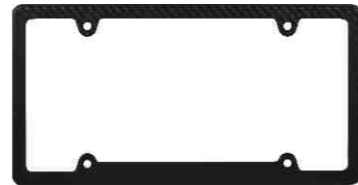

AK-8314CF



AMERICAN
CARBON FIBER

AK-8323



AMERICAN
CARBON FIBER

AK-8350CF



AMERICAN
ABS + CARBON FIBER

AK-8367



AMERICAN

AK-8363



AMERICAN
STAINLESS STEEL

AK-8325



AMERICAN
ALUMINUM ALLOY



LICENSE PLATE FRAME

AK-8347

AMERICAN
IRON



AK-8351

AMERICAN
LICENSE PLATE COVER



AK-8321

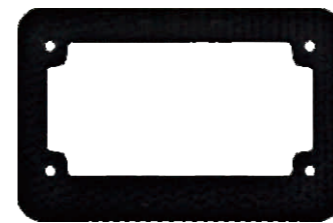

A



B

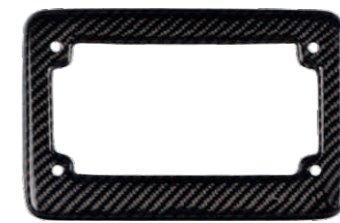

CF

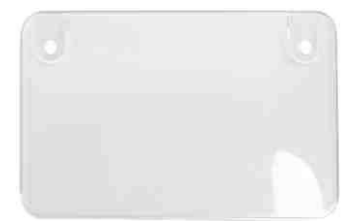

C

AK-8338

MALAYSIA
SILICA GEL

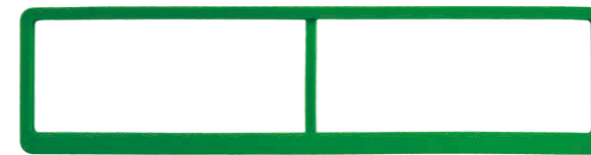

AK-8339

EUROPEAN
SILICA GEL



AK-8334

JAPAN
SILICA GEL



AK-8335

AMERICAN
SILICA GEL

